



Department
for Education

National Centre
for Excellence in the
Teaching of Mathematics



Mathematics guidance: key stages 1 and 2

**Non-statutory guidance for the national
curriculum in England**

June 2020

Contents

Acknowledgements	3
Summary	4
Introduction	5
Ready-to-progress criteria: year 1 to year 6	9
Year 1 guidance	16
Year 2 guidance	48
Year 3 guidance	82
Year 4 guidance	143
Year 5 guidance	208
Year 6 guidance	278
Appendix: number facts fluency overview	332

Acknowledgements

We would like to thank and acknowledge the following people involved in the production of this publication:

Dr Debbie Morgan (Director for Primary Mathematics, NCETM); Clare Christie (Maths Consultant and Lead Practitioner, Ashley Down Primary School); Professor Anne Watson (Emeritus Professor in Mathematics Education, University of Oxford); Dr Yvette Sturdy (Development Editor, DiGiV8 Ltd.); Jalita Jacobson (Editor and Illustrator); Steve Evans (Illustrator); Dr Xinfeng Huang, (Associate Professor, Shanghai Normal University); Elizabeth Lambert (Assistant Director for Primary, NCETM); Emma Patman (Assistant Director for Primary, NCETM); Carol Knights (Director for Secondary, NCETM); Kris Dong (Deputy Head of Primary, National Nord Anglia Chinese International School Shanghai); Ellie Swidryk (Mastery Specialist Teacher, Shrubland Street Primary School); Thomas Hassall (Mastery Specialist Teacher, St Andrew's Junior School); David Byron (Mastery Specialist Teacher, Cathedral Primary School, Bristol); Thomas Henesey (Mastery Specialist Teacher, Kingsholm C of E Primary School); Ione Haroun (Mastery Specialist Teacher, St White's Primary School); Farzana Khan (Mastery Specialist Teacher, Astwood Bank Primary School); Joanne Lane (Mastery Specialist Teacher, Stourport Primary Academy); Cat Potter (Head of Mathematics, Trinity Academy Bristol).

Summary

This publication provides non-statutory guidance from the Department for Education. It has been produced to help teachers and schools make effective use of the National Curriculum to develop primary school pupils' mastery of mathematics.

Who is this publication for?

This guidance is for:

- local authorities
- school leaders, school staff and governing bodies in all maintained schools, academies and free schools

Introduction

Aims of the publication

This publication aims to:

- bring greater coherence to the national curriculum by exposing core concepts in the national curriculum and demonstrating progression from year 1 to year 6
- summarise the most important knowledge and understanding within each year group and important connections between these mathematical topics

What is included in the publication?

This publication identifies the most important conceptual knowledge and understanding that pupils need as they progress from year 1 to year 6. These important concepts are referred to as ready-to-progress criteria and provide a coherent, linked framework to support pupils' mastery of the primary mathematics curriculum. The ready-to-progress criteria for all year groups are provided at the end of the introduction ([Ready-to-progress criteria](#)), and each criterion is explained within the corresponding year-group chapter.

Please note that the publication does not address the whole of the primary curriculum, but only the areas that have been identified as a priority. It is still a statutory requirement that the whole of the curriculum is taught. However, by meeting the ready-to-progress criteria, pupils will be able to more easily access many of the elements of the curriculum that are not covered by this guidance.

The year-group chapters

Each chapter begins with a table that shows how each ready-to-progress criterion for that year group links to pupils' prior knowledge and future applications. Each year-group chapter then provides:

- **teaching guidance** for each ready-to-progress criterion, including core mathematical representations, language structures and discussion of connections to other criteria
- **example assessment questions** for each ready-to-progress criterion
- guidance on the development of **calculation and fluency**

Representations of the mathematics

A core set of representations have been selected to expose important mathematical structures and ideas, and make them accessible to pupils. Consistent use of the same representations across year groups help to connect prior learning to new learning. The

example below demonstrates the use of tens frames and counters extended from year 1, where each counter represents 1 and a filled frame represents 10, to year 4 where each counter represents 100 a filled frame represents 1,000.

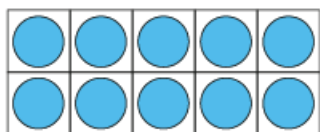

Figure 1: using a tens frame and counters



Figure 2: using a tens frame and counters

Language structures

The development and use of precise and accurate language in mathematics is important, so the guidance includes ‘Language focus’ features. These provide suggested sentence structures for pupils to use to capture, connect and apply important mathematical ideas. Once pupils have learnt to use a core sentence structure, they should be able to adapt and reason with it to apply their understanding in new contexts.

Language focus

“8 plus 6 is equal to 14, so 8 hundreds plus 6 hundreds is equal to 14 hundreds.”

“14 hundreds is equal to 1,400.”

Making Connections

‘Making connections’ features discuss important connections between ready-to-progress criteria within a year group. The example below describes how division with remainders is connected to multiplication and fractions criteria.

Making connections

Pupils must have automatic recall of multiplication facts and related division facts, and be able to recognise multiples ([4NF-1](#)) before they can solve division problems with remainders. For example, to calculate $55 \div 7$, pupils need to be able to identify the largest multiple of 7 that is less than 55 (in this case 49). They must then recall how many sevens there are in 49, and calculate the remainder.

Converting improper fractions to mixed numbers ([4F-2](#)) relies on solving division problems with remainders. For example, converting $\frac{19}{6}$ to a mixed number depends on the calculation $19 \div 6 = 3 \text{ r } 1$.

Assessment

Example assessment questions are provided for each ready to progress criterion. These questions demonstrate the depth and breadth of understanding that pupils need to be ready to progress to the next year group.

Calculation and fluency

Each chapter ends with a section on the development of calculation methods and fluency. Pupils should be able to choose and use efficient calculation methods for addition, subtraction, multiplication and division. They must also have automatic recall of a core set of multiplicative and additive facts to enable them to focus on learning new concepts. [Appendix: number facts fluency overview](#)

sets out when the multiplication tables and core additive facts should be taught, and in what order.

How to use this publication

This publication can support long-term, medium-term and short-term planning, and assessment. At the long-term planning stage, this guidance can be used to ensure that the most important elements that underpin the curriculum are covered at the right time, and to ensure that there is continuity and consistency for pupils as they progress from one year group to the next. At the medium-term planning stage, teachers can use the guidance to inform decisions on how much teaching time to set aside for the different parts of the curriculum. Teaching time can be weighted towards the ready-to-progress criteria. The ready-to-progress tables at the start of each year group and the 'Making connections' features support medium-term planning by demonstrating how to make connections between mathematical ideas and develop understanding based on logical progression. At the short-term planning stage, the guidance can be used to inform teaching strategy, and the representations and 'Language focus' features can be used to make concepts more accessible to pupils.

The publication can also be used to support transition conversations between teachers of adjacent year groups, so that class teachers understand what pupils have been taught in the previous year group, how they have been taught it, and how effectively pupils have understood and remembered it.

Ready-to-progress criteria and the curriculum

The ready-to-progress criteria in this document are organised into 6 strands, each of which has its own code for ease of identification. These are listed below. *Measurement* and *Statistics* are integrated as applications of number criteria, and elements of measurement that relate to shape are included in the *Geometry* strand.

Ready-to-progress criteria strands	Code
Number and place value	NPV
Number facts	NF
Addition and subtraction	AS
Multiplication and division	MD
Fractions	F
Geometry	G

Special educational needs and disability (SEND)

Pupils should have access to a broad and balanced curriculum. The *National Curriculum Inclusion Statement* states that teachers should set high expectations for every pupil, whatever their prior attainment. Teachers should use appropriate assessment to set targets which are deliberately ambitious. Potential areas of difficulty should be identified and addressed at the outset. Lessons should be planned to address potential areas of difficulty and to remove barriers to pupil achievement. In many cases, such planning will mean that pupils with SEN and disabilities will be able to study the full national curriculum. The guidance in this document will support planning for all SEND pupils by highlighting the most important concepts within the national curriculum so that teaching and targeted support can be weighted towards these.

Ready-to-progress criteria: year 1 to year 6

The table below is a summary of the ready-to-progress criteria for all year groups.

Strand	Year 1	Year 2	Year 3	Year 4	Year 5	Year 6
NPV	1NPV-1 Count within 100, forwards and backwards, starting with any number.		3NPV-1 Know that 10 tens are equivalent to 1 hundred, and that 100 is 10 times the size of 10; apply this to identify and work out how many 10s there are in other three-digit multiples of 10.	4NPV-1 Know that 10 hundreds are equivalent to 1 thousand, and that 1,000 is 10 times the size of 100; apply this to identify and work out how many 100s there are in other four-digit multiples of 100.	5NPV-1 Know that 10 tenths are equivalent to 1 one, and that 1 is 10 times the size of 0.1. Know that 100 hundredths are equivalent to 1 one, and that 1 is 100 times the size of 0.01. Know that 10 hundredths are equivalent to 1 tenth, and that 0.1 is 10 times the size of 0.01.	6NPV-1 Understand the relationship between powers of 10 from 1 hundredth to 10 million, and use this to make a given number 10, 100, 1,000, 1 tenth, 1 hundredth or 1 thousandth times the size (multiply and divide by 10, 100 and 1,000).
		2NPV-1 Recognise the place value of each digit in two-digit numbers, and compose and decompose two-digit numbers using standard and non-standard partitioning.	3NPV-2 Recognise the place value of each digit in <i>three</i> -digit numbers, and compose and decompose <i>three</i> -digit numbers using standard and non-standard partitioning.	4NPV-2 Recognise the place value of each digit in <i>four</i> -digit numbers, and compose and decompose <i>four</i> -digit numbers using standard and non-standard partitioning.	5NPV-2 Recognise the place value of each digit in numbers with up to 2 decimal places, and compose and decompose numbers with up to 2 decimal places using standard and non-standard partitioning.	6NPV-2 Recognise the place value of each digit in numbers up to 10 million, including decimal fractions, and compose and decompose numbers up to 10 million using standard and non-standard partitioning.
	1NPV-2 Reason about the location of numbers to 20 within the linear number system, including comparing using $<$ $>$ and $=$	2NPV-2 Reason about the location of any two-digit number in the linear number system, including identifying the previous and next multiple of 10.	3NPV-3 Reason about the location of any <i>three</i> -digit number in the linear number system, including identifying the previous and next multiple of 100 and 10.	4NPV-3 Reason about the location of any <i>four</i> -digit number in the linear number system, including identifying the previous and next multiple of 1,000 and 100, and rounding to the nearest of each.	5NPV-3 Reason about the location of any number with up to 2 decimals places in the linear number system, including identifying the previous and next multiple of 1 and 0.1 and rounding to the nearest of each.	6NPV-3 Reason about the location of any number up to 10 million, including decimal fractions, in the linear number system, and round numbers, as appropriate, including in contexts.

Strand	Year 1	Year 2	Year 3	Year 4	Year 5	Year 6
NPV			3NPV-4 Divide 100 into 2, 4, 5 and 10 equal parts, and read scales/number lines marked in multiples of 100 with 2, 4, 5 and 10 equal parts. →	4NPV-4 Divide 1,000 into 2, 4, 5 and 10 equal parts, and read scales/number lines marked in multiples of 1,000 with 2, 4, 5 and 10 equal parts. →	5NPV-4 Divide 1 into 2, 4, 5 and 10 equal parts, and read scales/number lines marked in units of 1 with 2, 4, 5 and 10 equal parts. →	6NPV-4 Divide powers of 10, from 1 hundredth to 10 million, into 2, 4, 5 and 10 equal parts, and read scales/number lines with labelled intervals divided into 2, 4, 5 and 10 equal parts.
					5NPV-5 Convert between units of measure, including using common decimals and fractions.	
NF	1NF-1 Develop fluency in addition and subtraction facts within 10. →	2NF-1 Secure fluency in addition and subtraction facts within 10, through continued practice. →	3NF-1 Secure fluency in addition and subtraction facts that bridge 10, through continued practice.			
	1NF-2 Count forwards and backwards in multiples of 2, 5 and 10, up to 10 multiples, beginning with any multiple, and count forwards and backwards through the odd numbers. →		3NF-2 Recall multiplication facts, and corresponding division facts, in the 10, 5, 2, 4 and 8 multiplication tables, and recognise products in these multiplication tables as multiples of the corresponding number. →	4NF-1 Recall multiplication and division facts up to 12×12 , and recognise products in multiplication tables as multiples of the corresponding number. →	5NF-1 Secure fluency in multiplication table facts, and corresponding division facts, through continued practice.	
				4NF-2 Solve division problems, with two-digit dividends and one-digit divisors, that involve remainders, and interpret remainders appropriately according to the context.		
			3NF-3 Apply place-value knowledge to known additive and multiplicative number facts (scaling facts by 10). →	4NF-3 Apply place-value knowledge to known additive and multiplicative number facts (scaling facts by 100) →	5NF-2 Apply place-value knowledge to known additive and multiplicative number facts (scaling facts by 1 tenth or 1 hundredth).	

Strand	Year 1	Year 2	Year 3	Year 4	Year 5	Year 6
AS	1AS-1 Compose numbers to 10 from 2 parts, and partition numbers to 10 into parts, including recognising odd and even numbers.	2AS-1 Add and subtract across 10.	3AS-1 Calculate complements to 100.			6AS/MD-1 Understand that 2 numbers can be related additively or multiplicatively, and quantify additive and multiplicative relationships (multiplicative relationships restricted to multiplication by a whole number).
	1AS-2 Read, write and interpret equations containing addition (+), subtraction (-) and equals (=) symbols, and relate additive expressions and equations to real-life contexts.	2AS-2 Recognise the subtraction structure of 'difference' and answer questions of the form, "How many more...?".	3AS-2 Add and subtract up to three-digit numbers using columnar methods.			6AS/MD-2 Use a given additive or multiplicative calculation to derive or complete a related calculation, using arithmetic properties, inverse relationships, and place-value understanding.
		2AS-3 Add and subtract within 100 by applying related one-digit addition and subtraction facts: add and subtract only ones or only tens to/from a two-digit number.	3AS-3 Manipulate the additive relationship: Understand the inverse relationship between addition and subtraction, and how both relate to the part-part-whole structure. Understand and use the commutative property of addition, and understand the related property for subtraction.			6AS/MD-3 Solve problems involving ratio relationships.
		2AS-4 Add and subtract within 100 by applying related one-digit addition and subtraction facts: add and subtract any 2 two-digit numbers.				6AS/MD-4 Solve problems with 2 unknowns.

Strand	Year 1	Year 2	Year 3	Year 4	Year 5	Year 6
MD		2MD-1 Recognise repeated addition contexts, representing them with multiplication equations and calculating the product, within the 2, 5 and 10 multiplication tables.	3MD-1 Apply known multiplication and division facts to solve contextual problems with different structures, including quotitive and partitive division.	4MD-1 Multiply and divide whole numbers by 10 and 100 (keeping to whole number quotients); understand this as equivalent to making a number 10 or 100 times the size. →	5MD-1 Multiply and divide numbers by 10 and 100; understand this as equivalent to making a number 10 or 100 times the size, or 1 tenth or 1 hundredth times the size.	For year 6, MD ready-to-progress criteria are combined with AS ready-to-progress criteria (please see above).
		2MD-2 Relate grouping problems where the number of groups is unknown to multiplication equations with a missing factor, and to division equations (quotitive division).		4MD-2 Manipulate multiplication and division equations, and understand and apply the commutative property of multiplication.	5MD-2 Find factors and multiples of positive whole numbers, including common factors and common multiples, and express a given number as a product of 2 or 3 factors.	
				4MD-3 Understand and apply the distributive property of multiplication. →	5MD-3 Multiply any whole number with up to 4 digits by any one-digit number using a formal written method.	
					5MD-4 Divide a number with up to 4 digits by a one-digit number using a formal written method, and interpret remainders appropriately for the context.	

Strand	Year 1	Year 2	Year 3	Year 4	Year 5	Year 6
F			3F-1 Interpret and write proper fractions to represent 1 or several parts of a whole that is divided into equal parts.			6F-1 Recognise when fractions can be simplified, and use common factors to simplify fractions.
			3F-2 Find unit fractions of quantities using known division facts (multiplication tables fluency). →		5F-1 Find non-unit fractions of quantities.	6F-2 Express fractions in a common denomination and use this to compare fractions that are similar in value.
			3F-3 Reason about the location of any fraction within 1 in the linear number system. →	4F-1 Reason about the location of mixed numbers in the linear number system.		6F-3 Compare fractions with different denominators, including fractions greater than 1, using reasoning, and choose between reasoning and common denomination as a comparison strategy.
				4F-2 Convert mixed numbers to improper fractions and vice versa.	5F-2 Find equivalent fractions and understand that they have the same value and the same position in the linear number system.	
			3F-4 Add and subtract fractions with the same denominator, within 1. →	4F-3 Add and subtract improper and mixed fractions with the same denominator, including bridging whole numbers.	5F-3 Recall decimal fraction equivalents for $\frac{1}{2}$, $\frac{1}{4}$, $\frac{1}{5}$ and $\frac{1}{10}$, and for multiples of these proper fractions.	
G	1G-1 Recognise common 2D and 3D shapes presented in different orientations, and know that rectangles, triangles, cuboids and pyramids are not always similar to one another. →	2G-1 Use precise language to describe the properties of 2D and 3D shapes, and compare shapes by reasoning about similarities and differences in properties. →	3G-1 Recognise right angles as a property of shape or a description of a turn, and identify right angles in 2D shapes presented in different orientations.		5G-1 Compare angles, estimate and measure angles in degrees (°) and draw angles of a given size.	

Strand	Year 1	Year 2	Year 3	Year 4	Year 5	Year 6
G					5G-2 Compare areas and calculate the area of rectangles (including squares) using standard units.	
	1G-2 Compose 2D and 3D shapes from smaller shapes to match an example, including manipulating shapes to place them in particular orientations. →		3G-2 Draw polygons by joining marked points, and identify parallel and perpendicular sides. →	4G-1 Draw polygons, specified by coordinates in the first quadrant, and translate within the first quadrant. →		6G-1 Draw, compose, and decompose shapes according to given properties, including dimensions, angles and area, and solve related problems.
				4G-2 Identify regular polygons, including equilateral triangles and squares, as those in which the side-lengths are equal and the angles are equal. Find the perimeter of regular and irregular polygons.		
				4G-3 Identify line symmetry in 2D shapes presented in different orientations. Reflect shapes in a line of symmetry and complete a symmetric figure or pattern with respect to a specified line of symmetry.		

Year 1 guidance

Ready-to-progress criteria

Previous experience	Year 1 ready-to-progress criteria	Future applications
Begin to develop a sense of the number system by verbally counting forward to and beyond 20, pausing at each multiple of 10.	1NPV-1 Count within 100, forwards and backwards, starting with any number.	Count through the number system. Place value within 100. Compare and order numbers. Add and subtract within 100.
Play games that involve moving along a numbered track, and understand that larger numbers are further along the track.	1NPV-2 Reason about the location of numbers to 20 within the linear number system, including comparing using $<$ $>$ and $=$	Reason about the location of larger numbers within the linear number system. Compare and order numbers. Read scales.
Begin to experience partitioning and combining numbers within 10.	1NF-1 Develop fluency in addition and subtraction facts within 10.	Add and subtract across 10. All future additive calculation. Add within a column during columnar addition when the column sums to less than 10 (no regrouping). Subtract within a column during columnar subtraction when the minuend of the column is larger than the subtrahend (no exchanging).
Distribute items fairly, for example, put 3 marbles in each bag. Recognise when items are distributed unfairly.	1NF-2 Count forwards and backwards in multiples of 2, 5 and 10, up to 10 multiples, beginning with any multiple, and count forwards and backwards through the odd numbers.	Recall the 2, 5 and 10 multiplication tables. Carry out repeated addition and multiplication of 2, 5, and 10, and divide by 2, 5 and 10. Identify multiples of 2, 5 and 10. Unitise in tens. Identify odd and even numbers.

Previous experience	Year 1 ready-to-progress criteria	Future applications
<p>Understand the cardinal value of number words, for example understanding that 'four' relates to 4 objects.</p> <p>Subitise for up to to 5 items.</p> <p>Automatically show a given number using fingers.</p>	<p>1AS-1 Compose numbers to 10 from 2 parts, and partition numbers to 10 into parts, including recognising odd and even numbers.</p>	<p>Add and subtract within 10.</p>
<p>Devise and record number stories, using pictures, numbers and symbols (such as arrows).</p>	<p>1AS-2 Read, write and interpret equations containing addition (+), subtraction (−) and equals (=) symbols, and relate additive expressions and equations to real-life contexts.</p>	<p>Represent composition and decomposition of numbers using equations.</p>
<p>See, explore and discuss models of common 2D and 3D shapes with varied dimensions and presented in different orientations (for example, triangles not always presented on their base).</p>	<p>1G-1 Recognise common 2D and 3D shapes presented in different orientations, and know that rectangles, triangles, cuboids and pyramids are not always similar to one another.</p>	<p>Describe properties of shape.</p> <p>Categorise shapes.</p> <p>Identify similar shapes.</p>
<p>Select, rotate and manipulate shapes for a particular purpose, for example:</p> <ul style="list-style-type: none"> • rotating a cylinder so it can be used to build a tower • rotating a puzzle piece to fit in its place 	<p>1G-2 Compose 2D and 3D shapes from smaller shapes to match an example, including manipulating shapes to place them in particular orientations.</p>	<p>Find the area or volume of a compound shape by decomposing into constituent shapes.</p> <p>Rotate, translate and reflect 2D shapes.</p> <p>Identify congruent shapes.</p>

1NPV–1 Count forwards and backwards within 100

Count within 100, forwards and backwards, starting with any number.

1NPV–1 Teaching guidance

Counting to and across 100, forwards and backwards, is a skill that will need to be practised regularly throughout year 1.

Counting provides a good opportunity to link number names to numerals, and to the position of numbers in the linear number system. Practice should include:

- reciting number names, without the support of visual representations, to allow pupils to focus on and develop fluency in the verbal patterns
- counting with the support of visual representations and gestural patterns, for example pupils can point to numerals on a 100 square or number line, or tap out the numbers on a Gattegno chart
- starting the counting sequence with numbers other than 1 or 100

1	2	3	4	5	6	7	8	9	10
11	12	13	14	15	16	17	18	19	20
21	22	23	24	25	26	27	28	29	30
31	32	33	34	35	36	37	38	39	40
41	42	43	44	45	46	47	48	49	50
51	52	53	54	55	56	57	58	59	60
61	62	63	64	65	66	67	68	69	70
71	72	73	74	75	76	77	78	79	80
81	82	83	84	85	86	87	88	89	90
91	92	93	94	95	96	97	98	99	100

Figure 3: 100 square



Figure 4: 0 to 100 number line

1,000	2,000	3,000	4,000	5,000	6,000	7,000	8,000	9,000
100	200	300	400	500	600	700	800	900
10	20	30	40	50	60	70	80	90
1	2	3	4	5	6	7	8	9

Figure 5: Gattegno chart showing multiples of 1, 10, 100 and 1,000

It is important to draw pupils' attention to structures in the number system, for example, linking 1, 2, 3, 4, 5... to 31, 32, 33, 34, 35..., and this can be supported by the use of the visual representations above.

Because number names in English do not always reflect the structure of the numbers, pupils should also practise using dual counting, first counting with number names, and then repeating the count with words based on the number structures.

Language focus

"...seven, eight, nine, ten, eleven, twelve, thirteen... twenty, twenty-one, twenty-two..."

"...seven, eight, nine, one-ten, one-ten-one, one-ten-two, one-ten-three... two-tens, two-tens-one, two-tens two..."

When counting backwards, pupils often find it challenging to identify which number they should say after they have said a multiple of 10. A partially marked number line can be used for support.

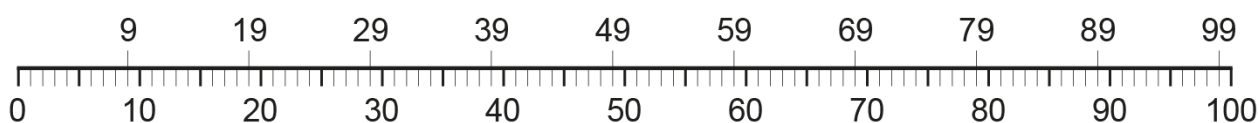

Figure 6: 0 to 100 number line to support backwards counting

Counting backwards from 20 down to 10 requires additional focused practice, due to the irregularity of these number names. By the end of year 1, pupils must be able to count forwards and backwards, within 100, without visual aids.

Making connections

Being able to count fluently, both forwards and backwards, is necessary for pupils to be able to reason about the location of numbers in the linear number system ([1NPV-2](#)) Sequencing in ones will extend to sequencing in multiples of 2, 5 and 10 ([1NF-2](#)).

1NPV-1 Example assessment questions

1. Fill in the missing numbers.

	8	9		11	12	
37	38		40		42	43
63	62		60		58	57

Assessment guidance: To assess criterion **1NPV-1**, teachers must listen to each pupil count. This can be done through specifically planned tasks, or by carefully watching and listening to an individual pupil during daily counting as part of class routines.

1NPV-2 Numbers to 20 in the linear number system

Reason about the location of numbers to 20 within the linear number system, including comparing using $<$ $>$ and $=$

1NPV-2 Teaching guidance

Pupils should be introduced to the number line as a representation of the order and relative size of numbers.

Pupils should:

- begin to develop the ability to mentally visualise a number line, with consecutive whole numbers equally spaced along it
- draw number lines, with consecutive whole numbers equally spaced along them
- identify or place numbers up to 20 on marked and unmarked number lines

Pupils should use efficient strategies and appropriate reasoning, including working backwards from a multiple of 10, to identify or place numbers on marked number lines.

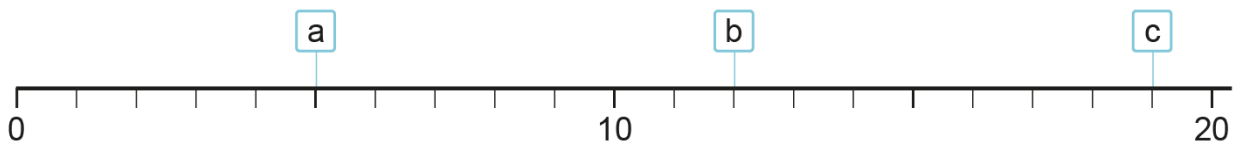

Figure 7: identifying 5, 12 and 19 on a marked 0 to 20 number line

Language focus

“a is 5 because it is halfway between 0 and 10.”

“b is 12 because it is 2 more than 10.”

“c is 19 because it is one less than 20.”

Pupils should also be able to estimate the value or position of numbers on unmarked number lines, using appropriate proportional reasoning, rather than counting on from a start point or back from an end point. Pupils should learn to estimate the value/position of a number relative to both ends of the number line, beginning with a 0 to 10 number line, then moving on to 0 to 20 and 10 to 20 number lines. When pupils are asked to mark all numbers on, for example, an unmarked 0 to 10 number line, they typically start at 1 and run out of space as they approach 10, and so bunch the larger numbers together. Pupils should learn to look at the full length of the number line and mark on the midpoint first. They should be able to reason about the location of numbers relative to both ends, and the midpoint, of a number line, for example, “16 is about here because it is just over halfway between 10 and 20.”

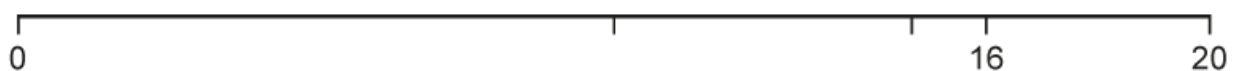

Figure 8: placing 16 on an unmarked 0 to 20 number line

There is no need for pupils to be completely accurate in their estimation of value or position of numbers. Rather they should make reasonable judgements that demonstrate they are developing proportional thinking.

Pupils should use their knowledge of the position of the numbers 0 to 10 on a number line to help them to estimate the value or position of the numbers 10 to 20.

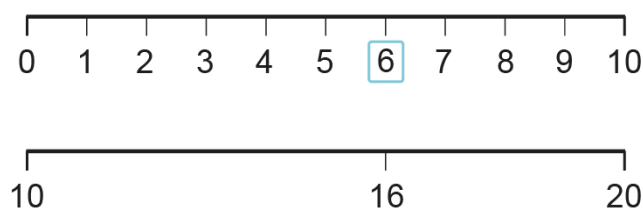

Figure 9: placing 16 on an unmarked 10 to 20 number line

Making connections

Being able to count fluently ([1NPV-1](#)), both forwards and backwards, is necessary for pupils to be able to reason about the location of numbers in the linear number system.

1NPV-2 Example assessment questions

1. Label these numbers on the number line.

9 15 3 12

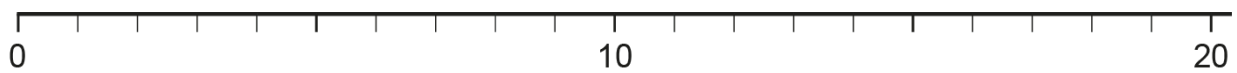

2. Estimate the value of the missing numbers.

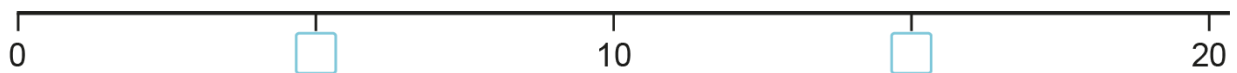

3. Mahmood is using 10cm paper strips to measure things in the classroom.

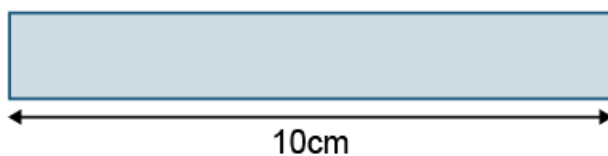

a. How long do you think the eraser is?

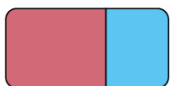
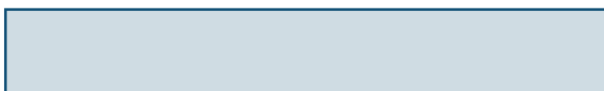

b. How long do you think the pencil is?

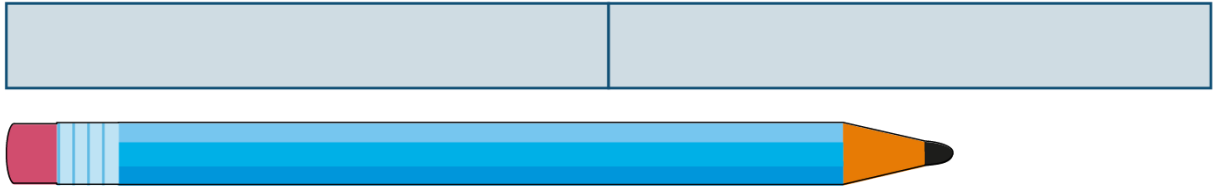

Images drawn to scale

4. Mia measures 2 different leaves with a ruler. How long is each leaf?

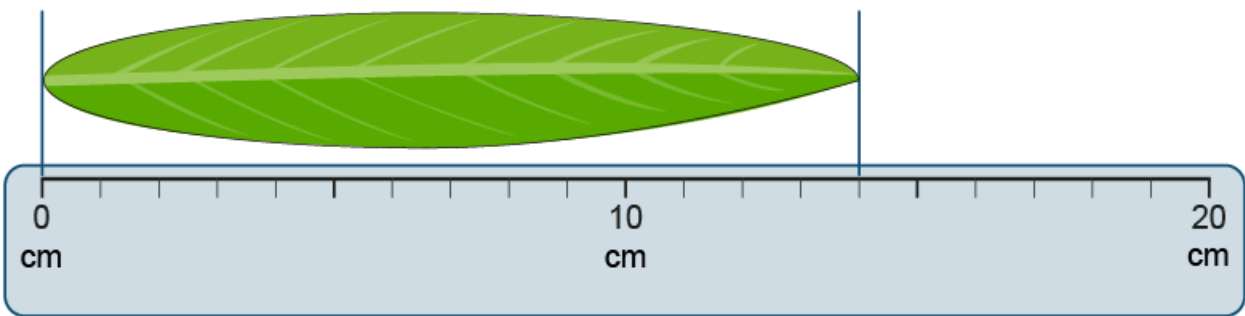
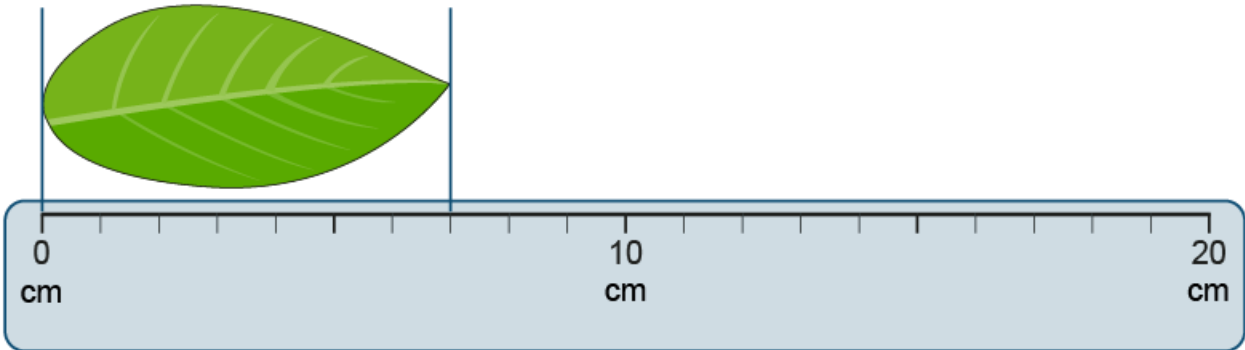

Images drawn to scale

Assessment guidance: The example questions above can be set as a written task. However, teachers will need to watch pupils closely to assess whether pupils are developing efficient strategies and appropriate proportional reasoning skills. Teachers should assess pupils in small groups.

1NF–1 Fluently add and subtract within 10

Develop fluency in addition and subtraction facts within 10.

1NF–1 Teaching guidance

It is very important for pupils to be able to add and subtract within 10, fluently, by the end of year 1. This should be taught and practised until pupils move beyond counting forwards or backwards in ones, to more efficient strategies and eventually to automatic recall of these number facts. This is necessary before pupils move on to additive calculation with larger numbers.

The 66 addition facts within 10 are shown on the grid below. The number of addition facts to be learnt is reduced when commutativity is applied and pupils recognise that $3 + 2$, for example, is the same as $2 + 3$. Pupils must also have automatic recall of the corresponding subtraction facts, for example $5 - 3$ and $5 - 2$.

+	0	1	2	3	4	5	6	7	8	9	10
0	$0+0$	$0+1$	$0+2$	$0+3$	$0+4$	$0+5$	$0+6$	$0+7$	$0+8$	$0+9$	$0+10$
1	$1+0$	$1+1$	$1+2$	$1+3$	$1+4$	$1+5$	$1+6$	$1+7$	$1+8$	$1+9$	
2	$2+0$	$2+1$	$2+2$	$2+3$	$2+4$	$2+5$	$2+6$	$2+7$	$2+8$		
3	$3+0$	$3+1$	$3+2$	$3+3$	$3+4$	$3+5$	$3+6$	$3+7$			
4	$4+0$	$4+1$	$4+2$	$4+3$	$4+4$	$4+5$	$4+6$				
5	$5+0$	$5+1$	$5+2$	$5+3$	$5+4$	$5+5$					
6	$6+0$	$6+1$	$6+2$	$6+3$	$6+4$						
7	$7+0$	$7+1$	$7+2$	$7+3$							
8	$8+0$	$8+1$	$8+2$								
9	$9+0$	$9+1$									
10	$10+0$										

Pupils should learn to compose and partition numbers within 10 ([1AS–1](#)) before moving on to formal addition and subtraction. Although [1NF–1](#) (this criterion) and [1AS–2](#) are presented as separate ready-to-progress criteria, they depend upon one another and should be developed, in tandem, throughout year 1.

As part of their work on **1AS-1**, pupils are likely to already have memorised some number bonds within 10 (for example, number bonds to 5, to 10 and some doubles facts). However, at this stage, most pupils won't remember all of their number facts by rote learning, so they should also be taught to derive additive facts within 10 from previously memorised facts or knowledge. Examples of appropriate strategies include the following.

Example strategy 1:

Language focus

“I know that double 3 is equal to 6, so 4 plus 3 is equal to 7.”

Example strategy 2:

Language focus

“If I subtract 2 from an even number I get the previous even number, so 6 minus 2 is equal to 4.”

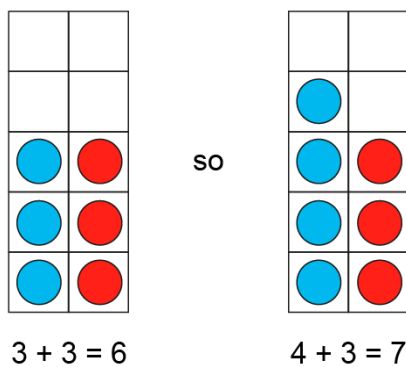

Figure 10: tens frames with counters showing derivation of a 'near-double' addition calculation

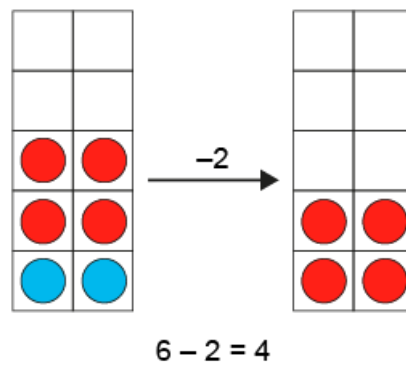

Figure 11: tens frames with counters showing that subtracting 2 from an even number gives the previous even number

Pupils need extensive practice to meet this criterion. You can find out more about fluency for addition and subtraction within 10 here in the calculation and fluency section: [1NF-1](#)

Making connections

Understanding how numbers within 10 can be composed and partitioned ([1AS-1](#)) underpins fluency in addition and subtraction facts within 10.

Pupils need to be able carry out these calculations when they are presented as equations, and when they are presented as contextual word problems as described in [1AS-2](#). The [1NF-1 Example assessment questions](#) below provide contextual problems only.

1NF–1 Example assessment questions

1. I cycled 4km to get to my friend’s house, and then cycled another 3km with my friend. How far have I cycled?
2. There are 9 children. 6 of them have scooters and the rest do not. How many of the children do not have scooters?
3. Sarah had £6. Then she spent £3. How much money does she have left?
4. I have 1 metre of red ribbon. I have 5 metres of blue ribbon. How many metres of ribbon do I have altogether?

1NF–2 Count forwards and backwards in multiples of 2, 5 and 10

Count forwards and backwards in multiples of 2, 5 and 10, up to 10 multiples, beginning with any multiple, and count forwards and backwards through the odd numbers.

1NF–2 Teaching guidance

Pupils must be able to count in multiples of 2, 5 and 10 by the end of year 1 so that they are ready to progress to multiplication involving groups of 2, 5 and 10 in year 2. As with counting in ones, within 100 (**1NPV–1**), this is a skill that will need to be practised throughout year 1.

As with **1NPV–1**, forwards and backwards counting practice should include:

- reciting just the number names (for example, “ten, twenty, thirty...”), without the support of visual representations
- counting with the support of visual representations and gestural patterns, for example pupils can point to numerals on a number line or 100 square, or tap out the numbers on a Gattegno chart
- starting the forwards counting sequence with numbers other than 2, 5 or 10

The 100 square and Gattegno chart are provided in criterion **1NPV–1** in figures 1 and 3 respectively.

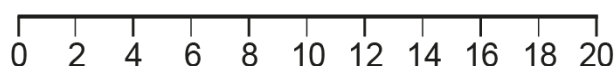

Figure 12: number line to support counting in multiples of 2

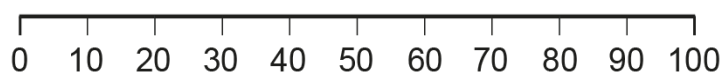

Figure 13: number line to support counting in multiples of 10

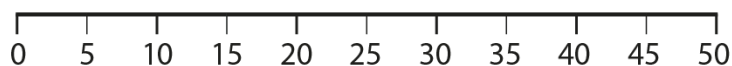

Figure 14: number line to support counting in multiples of 5

When pupils are confident with the counting sequences, they should learn to enumerate objects arranged in groups of 2, 5 or 10 by skip counting, so they begin to connect counting in multiples with finding the total quantity for repeated groups. Pupils should first identify how many objects are in each repeated group, and then skip count in this number. They should leave year 1 understanding that when objects are grouped equally, it is more efficient to skip count than to count in ones. Recognising that a group of 5, for example, can be treated as a single unit is called unitising, and is the basis of multiplicative reasoning.

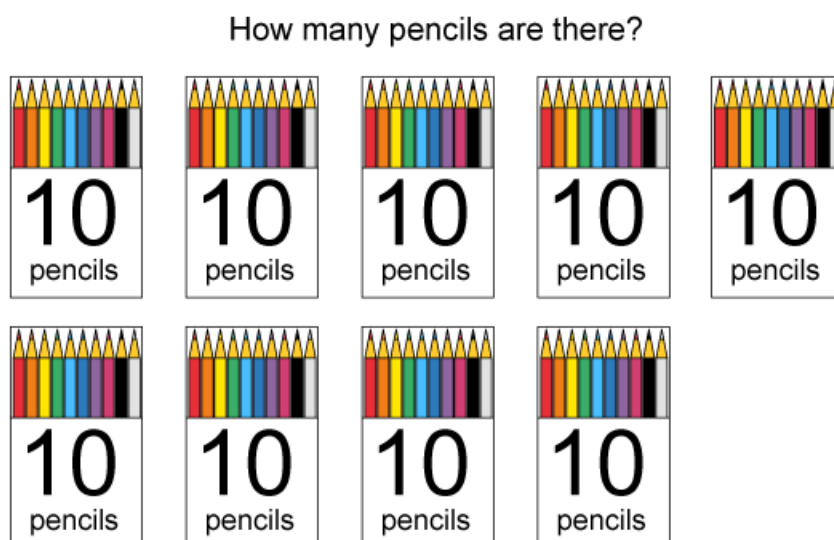

Figure 15: counting in tens – 9 packs of 10 pencils

Language focus

“The pencils are in groups of 10, so we will count in tens.”

Pupils should also practise counting in two ways: counting the total number of objects using skip counting, or counting the number of repeated groups. This will prepare pupils for multiplication and division in year 2.

Language focus

“Ten, twenty, thirty...”

“1 group of 10, 2 groups of 10, 3 groups of 10...”

In time, shortened to:

“1 ten, 2 tens, 3 tens...”

Once pupils have learnt to recognise 2p, 5p and 10p coins, they should be expected to apply their knowledge of counting in multiples of 2, 5 and 10 to find the value of a set of like coins, and to find how many of a particular denomination is required to pay for a given item – see [1NF-2](#) (questions 6 and 7).

Pupils should also learn to recite the odd number sequence, both forwards and backwards. This can initially be supported by a number line with odd numbers highlighted.

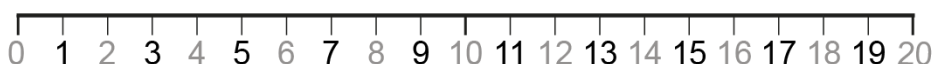

Figure 16: number line to support counting through the odd number sequence

Pupils need extensive practice to meet this criterion. You can find out more about fluency for counting in multiples of 2, 5 and 10 here in the calculation and fluency section:

[1NF-2](#)

Making connections

The patterns and structure in the number system which pupils learn from counting in ones ([1NPV-1](#)) will prepare pupils for learning to count in multiples of 2, 5 and 10.

In [1AS-1](#) pupils learn to identify odd and even numbers within 10. Counting in multiples of 2 (even numbers), and through the odd number sequence, demonstrates to pupils that the odd and even number patterns continue through the number system.

1NF–2 Example assessment questions

1. Task: Provide each pupil with an even number of counters up to 20, then ask pupils to:
 - a. put the counters into groups of 2
 - b. count in multiples of 2 find out how many counters there are
2. These sticks are grouped into bundles of 10. How many sticks are there altogether?

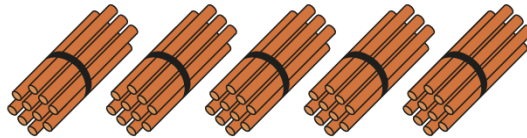

3. How many wheels are there altogether? Count in groups of 2.



4. There are 5 hedgehogs in each group. How many hedgehogs are there altogether?

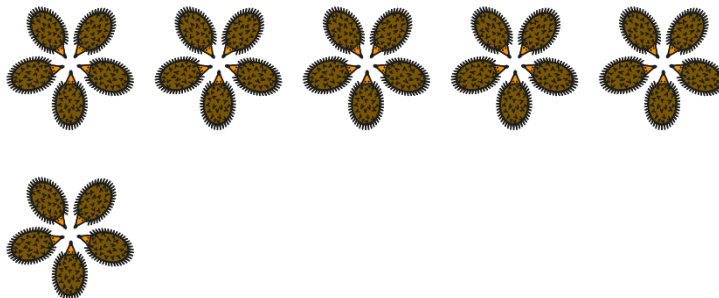

5. There are 5 dots on each token. How many dots are there altogether?

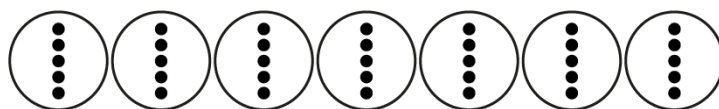

6. How much money is in each purse?



2p coins

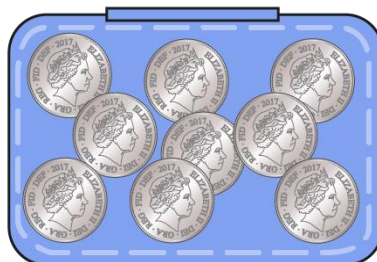

10p coins

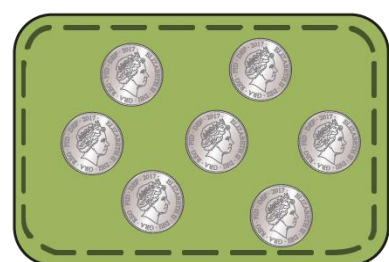

5p coins

7. Task: Provide each pupil with 2p, 5p and 10p coins (real or otherwise), then ask pupils to show how to pay for:
- the drum with 2p coins
 - the boat with 5p coins
 - the dinosaur with 10p coins

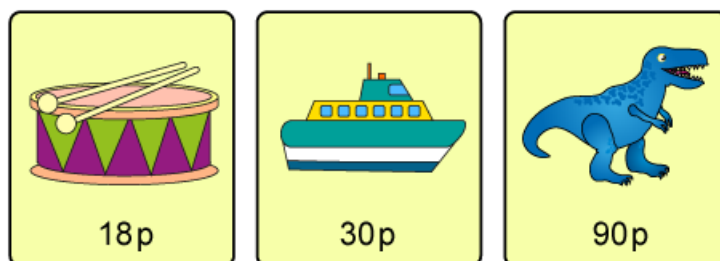

Assessment guidance: To assess whether pupils can recite the number sequences, teachers must listen to each pupil count. This can be done through specifically planned tasks, or by carefully watching and listening to an individual pupil during daily counting as part of class routines.

The example questions and tasks above can be used to assess whether pupils can enumerate objects in groups of 2, 5 or 10. However, simply providing the correct answers to the example questions does not demonstrate that a pupil has met this part of the criterion – teachers should assess pupils in small groups to ensure that they are counting in multiples of 2, 5 or 10 rather than in ones.





1AS–1 Compose and partition numbers to 10

Compose numbers to 10 from 2 parts, and partition numbers to 10 into parts, including recognising odd and even numbers.

1AS–1 Teaching guidance

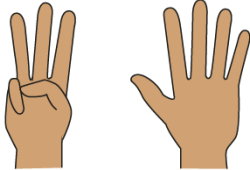
Learning to ‘see’ a whole number and the parts within it at the same time is an important stage in the development of pupils’ understanding of number. Composing numbers (putting parts together to make a whole) underpins addition, and decomposing a number into parts (partitioning) underpins subtraction. Exploring different ways that a number can be partitioned and put back together again helps pupils to understand that addition and subtraction are inverse operations.

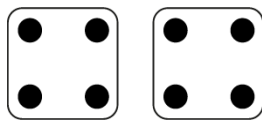
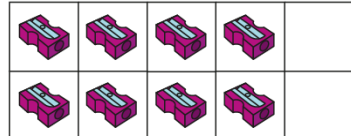
Pupils should be presented with varied cardinal (quantity) representations, both concrete and pictorial, which support identification of the ‘numbers within a number’. The examples below provide different ways of showing that 8 can be composed from 2 numbers. The representations draw attention to the parts within the whole.

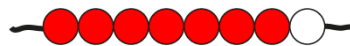
 <p>Figure 17: 8 represented as 3 fingers and 5 fingers</p>	 <p>Figure 18: 8 represented as 6 and 2 with base 10 number boards</p>	 <p>Figure 19: 8 represented as two 4-value dice</p>
 <p>Figure 20: 8 represented as 2 rows of 4</p>	 <p>Figure 21: 8 represented as tally marks: 5 and 3</p>	 <p>Figure 22: 8 represented on a bead string: 7 and 1</p>

Pupils should learn to interpret and sketch partitioning diagrams to represent the ways numbers can be partitioned or combined. At this stage, these should be used alongside quantity images to support development of the understanding of quantity. Pupils should be able to relate the numerals in the partitioning diagrams to the quantities in images, and use the language of parts and wholes to describe the relationship between the numbers.

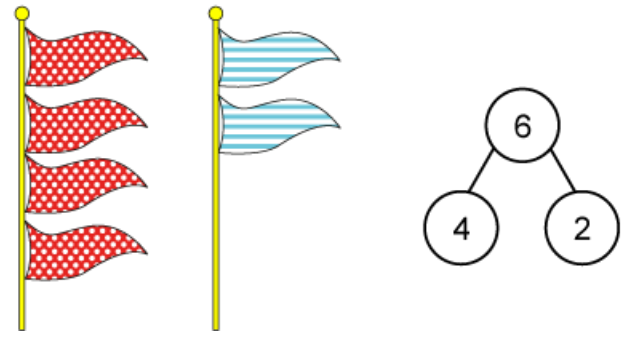

Figure 23: using a partitioning diagram to represent 6 flags, consisting of 4 spotty flags and 2 stripy flags

Language focus

“There are 6 flags. 4 are spotty and 2 are stripy.”

“6 is the whole. 4 is a part. 2 is a part.”

Pupils should also experience working with manipulatives and practise partitioning a whole number of items into parts, then putting the parts back together. They should understand that the total quantity is conserved. Pupils should repeatedly partition and recombine the whole, in different ways.

Pupils should learn how to work systematically to partition each of the numbers to 10 into 2 parts. They should recognise that there is a finite number of ways that a given number can be partitioned.

Pupils should pay attention to the patterns observed when working systematically, for example:

- in each step below, the value of one part increases by 1 and the value of the other part decreases by 1, while the whole remains the same
- number pairs are repeated, but with the values reversed, for example when 6 is the whole, the parts can be 2 and 4, or 4 and 2 (pupils must be able to identify what is the same and what is different between these two options; this lays the foundations for understanding the commutative property of addition)

Pupils must be able to describe and understand these patterns.







	Blue	Red
	0	6
	1	5
	2	4
	3	3
	4	2
	5	1
	6	0

Figure 24: working systematically to partition 6

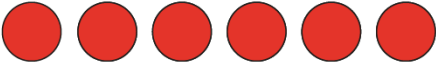
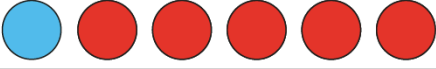
Once pupils have learnt to write addition and subtraction equations, they should use these to express the different ways that numbers can be composed and decomposed (see [1AS-2](#)), for example:

$$6 = 2 + 4$$

$$6 = 4 + 2$$

$$6 - 4 = 2$$

$$6 - 2 = 4$$

Pupils should learn to recognise odd and even numbers, up to 10, based on whether they can be composed of groups of 2 or not. Base 10 number boards, or tens frames with counters shown arranged in twos, can be used to expose the structure of odd and even numbers.

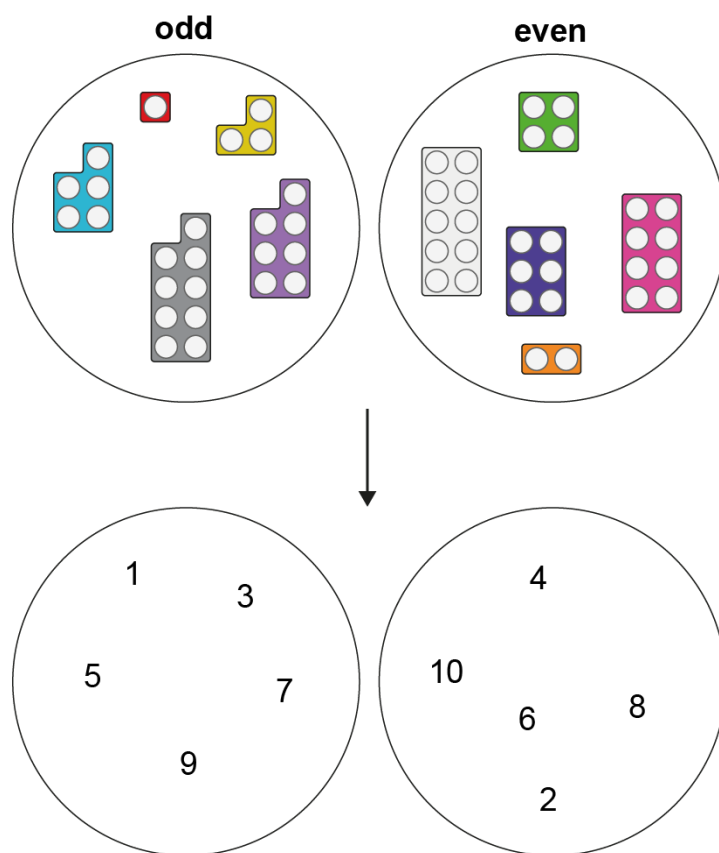

Figure 25: odd and even numbers up to 10

Making connections

Composing and decomposing numbers within 10 can be expressed with addition and subtraction equations ([1AS-2](#)), and is the basis of fluency in addition and subtraction facts within 10 ([1NF-1](#)). Here, pupils learn to identify odd and even numbers, while in [1NF-2](#) they develop fluency in the odd and even number sequences through practising skip counting.

1AS–1 Example assessment questions

1. Mother duck is in the water with her 6 ducklings. There are 2 ponds. How many ducklings could be in each pond?

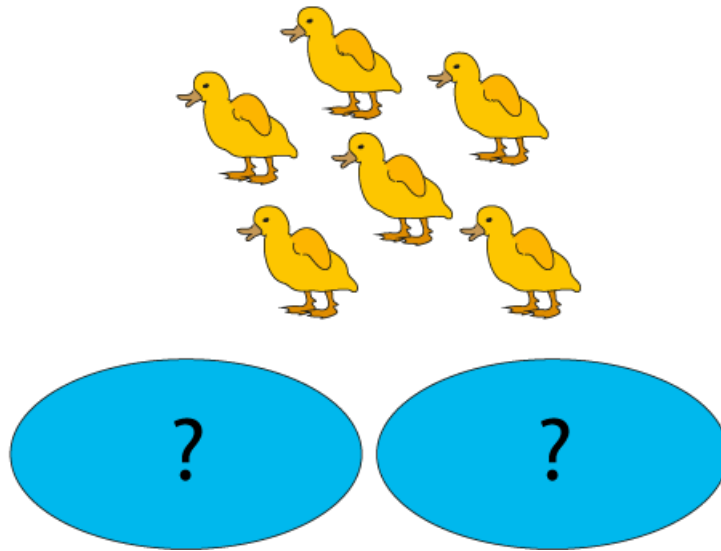

2. Fill in the missing numbers.

a.

$5 = 5 + 0$	
$5 = 4 + \square$	
$5 = 3 + \square$	
$5 = 2 + \square$	
$5 = 1 + \square$	
$5 = 0 + \square$	

b.

$7 + \square = 7$
$6 + \square = 7$
$5 + \square = 7$
$4 + \square = 7$
$3 + \square = 7$
$2 + \square = 7$
$1 + \square = 7$
$0 + \square = 7$

3. Task: Provide each pupil with a tens frame and counters in 2 colours, then ask pupils to use the manipulatives to answer questions such as the following.

“I am holding 9 counters altogether. How many counters are there in my closed hand?”

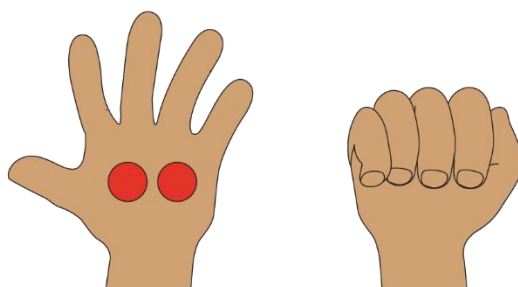

4. Underline the numbers that are in the wrong sorting circle.

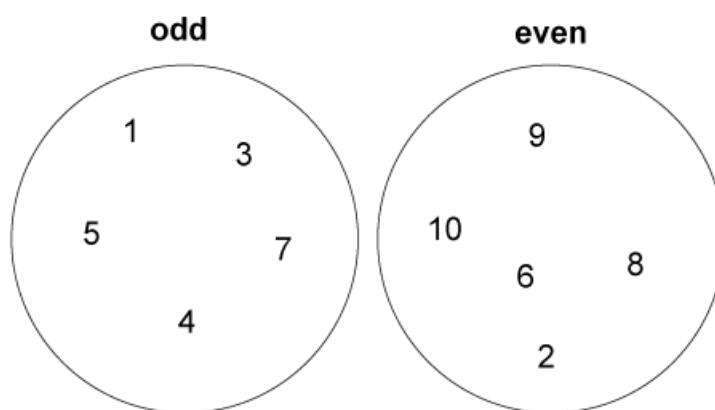

5. Write the missing numbers in these odd and even sequences.

1 | 3 | | | 9

2 | | 6 | | 10

Assessment guidance: The focus of this criterion is understanding that numbers can be composed from, and partitioned into, smaller numbers. Pupils are assessed separately on their fluency in number facts within 10, in criterion [1NF-1](#). Therefore manipulatives such as counters and tens frames, or counters and partitioning diagram templates, should be made available to pupils during assessment of this criterion so that the questions are not dependent on pupils' emerging number facts fluency.

Note that Example assessment question 2 relies on pupils having learnt to write and interpret addition and subtractions equations. This question should only be used to assess understanding of composition and partitioning after pupils have met criterion [1AS-2](#).

1AS–2 Read, write and interpret additive equations

Read, write and interpret equations containing addition (+), subtraction (–) and equals (=) symbols, and relate additive expressions and equations to real-life contexts.

1AS–2 Teaching guidance

Pupils must learn to use the mathematical symbols +, – and =. Expressions or equations involving these symbols should be introduced as a way to represent numerical situations and mathematical stories. An expression such as $3+5$ should not be interpreted as asking “What is $3+5$?” but, rather, as a way to represent the additive structures discussed below, either within a real-life context or within an abstract numerical situation. It is important that pupils do not think of the equals symbol as meaning ‘and the answer is’. They should instead understand that the expressions on each side of an equals symbol have the same value. All examples used to teach this criterion should use quantities within 10, and be supported by manipulatives or images, to ensure that pupils are able to focus on the mathematical structures and to avoid the cognitive load of having to work out the solutions.

For each of the 4 additive structures described below (aggregation, partitioning, augmentation and reduction), pupils should learn to link expressions (for example, $5+2$ and $6-2$) to contexts before they learn to link equations (for example, $5+2=7$ and $6-2=4$) to contexts. For each case, pupils’ understanding should be built up in steps:

1. Pupils should first learn to describe the context using precise language (see the language focus boxes below).
2. Pupils should then learn to write the associated expression or equation.
3. Pupils should then use precise language to describe what each number in the expression or equation represents.

Pupils need to be able to write and interpret expressions and equations to represent aggregation (combining 2 parts to make 1 whole) and partitioning (separating 1 whole into 2 parts).

How many flowers are there altogether?



$$5 + 2 = 7$$

Figure 26: addition as aggregation

Language focus

“There are 5 flowers in one bunch. There are 2 flowers in the other bunch. There are 7 flowers altogether.”

“We can write this as 5 plus 2 is equal to 7.”

“The 5 represents the number of flowers in 1 bunch.”

“The 2 represents the number of flowers in the other bunch.”

“The 7 represents the total number of flowers.”

Pupils must understand that, in partitioning situations, the subtraction symbol represents a splitting up or differentiating of the whole. The problem “There are 6 children altogether. 2 children are wearing coats. How many are not wearing coats?” is represented by $6 - 2 = 4$. Here, the subtraction symbol represents the separation of the 2 children wearing coats, and so, the number of children not wearing coats is exposed.

How many children are not wearing coats?

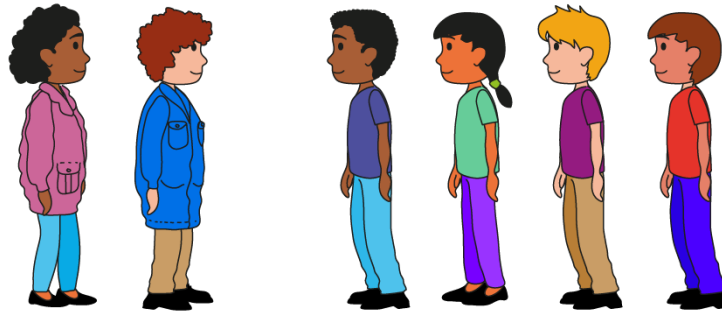

$$6 - 2 = 4$$

Figure 27: subtraction as partitioning

Language focus

“There are 6 children altogether. 2 children are wearing coats. 4 children are not wearing coats.”

“We can write this as 6 minus 2 is equal to 4.”

“The 6 represents the total number of children.”

“The 2 represents the number of children that are wearing coats.”

“The 4 represents the number of children that are not wearing coats.”

Pupils must also be able to write and interpret expressions and equations to represent **augmentation** (increasing a quantity by adding more) and **reduction** (decreasing a quantity by taking some away). Note that ‘take away’ should only be used to describe the subtraction operation in reduction contexts.

How many children are on the bus now?

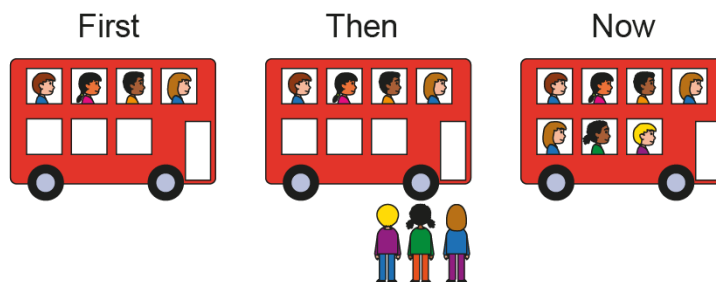

$$4 \quad + 3 \quad \rightarrow \quad 7$$

$$4 + 3 = 7$$

Figure 28: addition as augmentation

Language focus

“First 4 children were sitting on the bus. Then 3 more children got on the bus. Now 7 children are sitting on the bus.”

“We can write this as 4 plus 3 is equal to 7.”

“The 4 represents the number of children that were on the bus at the start.”

“The 3 represents the number of children that got on the bus.”

“The 7 represents the number of children that are on the bus now.”

How many children are in the bumper car now?

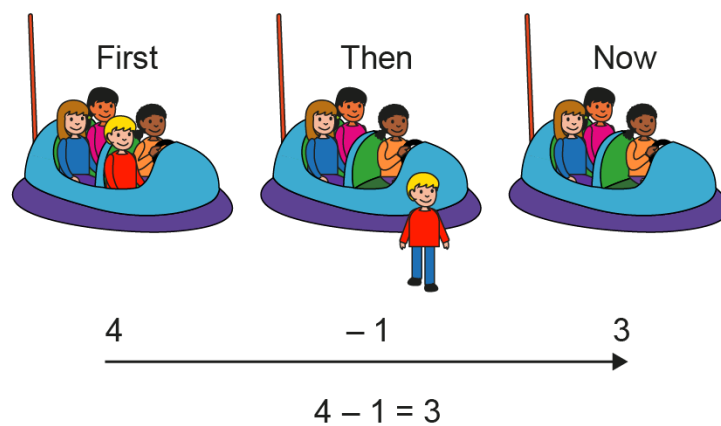

Figure 29: subtraction as reduction

Language focus

“First there were 4 children in the bumper car. Then 1 child got out. Now there are 3 children in the bumper car.”

“We can write this as 4 minus 1 is equal to 3.”

“The 4 represents the number of children that were in the car at the start.”

“The 1 represents the number of children that got out of the car.”

“The 3 represents the number of children that are in the car now.”

In the course of learning to read, write and interpret addition and subtractions equations, pupils should also learn that equations can be written in different ways, including:

- varying the position of the equals symbol (for example, $5 - 2 = 3$ and $3 = 5 - 2$)
- for addition, the addends can be written in either order and the sum remains the same (commutativity)

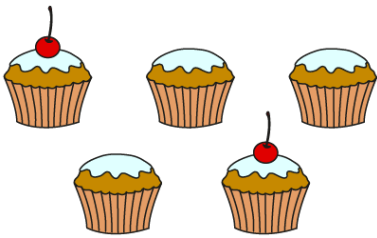

Figure 30: aggregation or partitioning context: 5 cakes altogether, 2 with cherries and 3 without

$$2 + 3 = 5$$

$$5 = 2 + 3$$

$$3 + 2 = 5$$

$$5 = 3 + 2$$

$$5 - 3 = 2$$

$$2 = 5 - 3$$

$$5 - 2 = 3$$

$$3 = 5 - 2$$

Pupils must also learn to relate addition and subtraction contexts and equations to mathematical diagrams such as bar models, number lines, tens frames with counters, and partitioning diagrams.

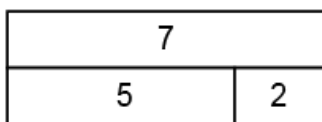

$$7 - 2 = 5$$

Figure 31: bar model and subtraction equation ($7 - 2 = 5$)

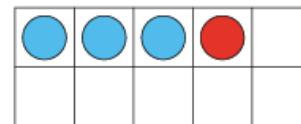

$$3 + 1 = 4$$

Figure 33: tens frame with counters and addition equation ($3 + 1 = 4$)

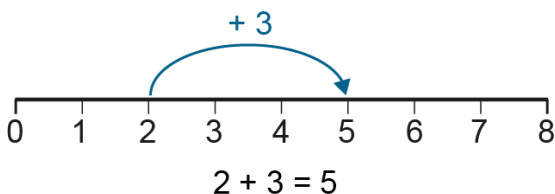

$$2 + 3 = 5$$

Figure 32: number line and addition equation ($2 + 3 = 5$)

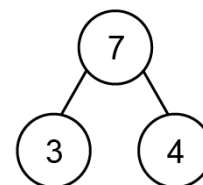

$$7 - 3 = 4$$

Figure 34: cherry partitioning model and subtraction equation ($7 - 3 = 4$)

Making connections

Once pupils have completed this criterion, they should represent the composition and partitioning of numbers to 10 ([1AS-1](#)) using addition and subtraction equations.

This criterion and [1AS-1](#) provide the conceptual prerequisites for pupils to develop fluency in addition and subtraction within 10 ([1NF-1](#)).

1AS–2 Example assessment questions

1. Write an equation to represent this story.

First I had 6 balloons. Then 2 floated away. Now I have 4 balloons.

2. Write an equation to represent this story.

There are 2 apples. There are 3 oranges. Altogether there are 5 pieces of fruit.

3. Which equation matches the picture? Can you explain your choice?

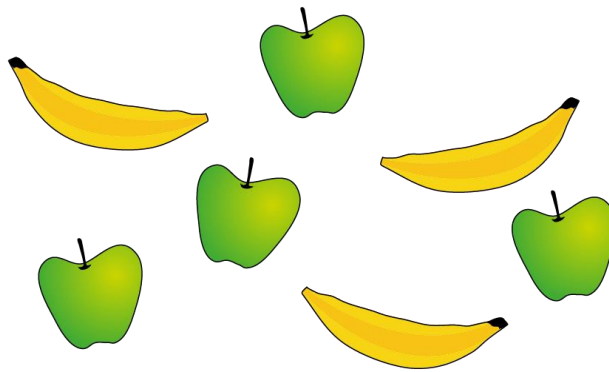

$3 + 3 = 6$

$8 = 4 + 3$

$4 = 3 + 1$

$4 + 3 = 7$

4. Holly looks at this picture. She writes $4 - 1 = 3$. Explain how Holly's equation represents the picture.

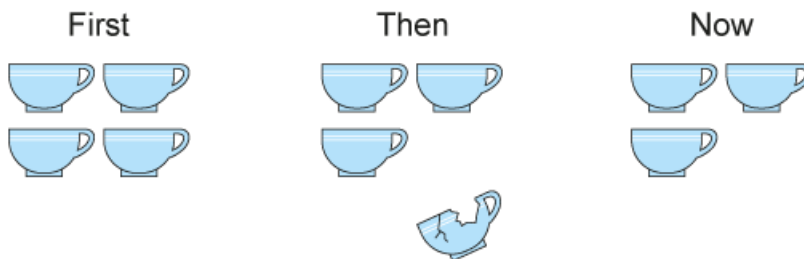

5. Write an equation to represent this picture. Explain how your equation matches the picture.



Assessment guidance: For pupils to meet this criterion, they need to demonstrate mastery of the structures. Correct calculation of the solutions to calculations is not required (this is assessed in [1NF-1](#)).

Where a question requires pupils to explain their reasoning, this should be done verbally.

1G-1 Recognise common 2D and 3D shapes

Recognise common 2D and 3D shapes presented in different orientations, and know that rectangles, triangles, cuboids and pyramids are not always similar to one another.

1G-1 Teaching guidance

Pupils need a lot of experience in exploring and discussing common 2D and 3D shapes. In the process, they should learn to recognise and name, at a minimum:

- rectangles (including squares), circles, and triangles
- cuboids (including cubes), cylinders, spheres and pyramids

Pupils need to be able to recognise common shapes when they are presented in a variety of orientations and sizes and relative proportions, including large shapes outside the classroom (such as a rectangle marked on the playground or a circle on a netball court). Pupils should be able to describe, using informal language (for example, “long and thin”), the differences between non-similar examples of the same shapes, and recognise that these are still examples of the given shape.

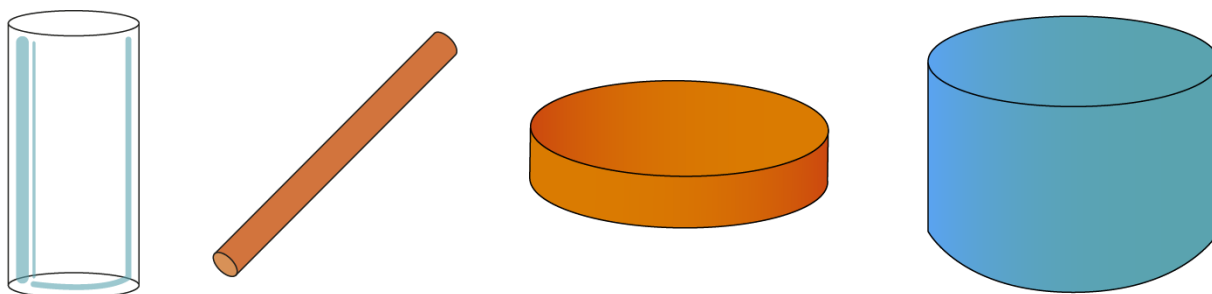

Figure 35: non-similar cylinders

Pupils should practise distinguishing a given named shape type from plausible distractors. These activities should involve exploring shapes (for example, shapes cut from card) rather than only looking at pictures.

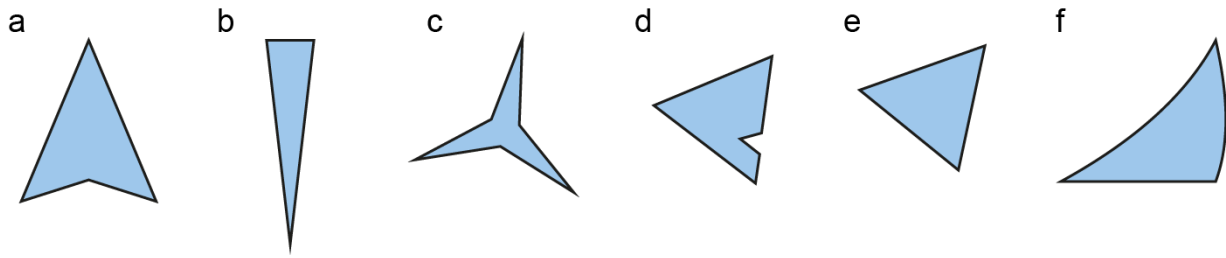

Figure 36: distinguishing triangles from plausible distractors

Language focus

Shape a: “This is not a triangle because it has 4 sides.”

Shape b or e: “This is a triangle because it has 3 straight sides.”

Shape c or d: “This is not a triangle because it has 6 sides.”

Shape f: “This is not a triangle because some sides are curved.”

Making connections

Categorising examples and non-examples (for example, determining which shapes are triangles and which are not) is an important mathematical skill. Pupils should be developing this skill here and in other contexts, such as in [1AS-1](#), where they categorise numbers according to whether they are even or not even.

1G-1 Example assessment questions

1. Task: Lay out a selection of 3D shapes, then ask “Can you find 3 different cuboids?”
2. Task: Lay out a selection of 2D shapes that include triangles and plausible distractors, and other 2D shapes, then instruct pupils to choose 3 shapes as follows:
 - a triangle
 - a shape that reminds you of a triangle but is not one
 - a shape which is nothing like a triangle
3. Task: Lay out a selection of shapes, hold up one of them, and ask:
 - “I wonder whether this shape is a rectangle. What do you think?”
 - “Can you find a shape which is a rectangle?” (if the original shape is not a rectangle)

4. Task: Lay out a selection of shapes, hold up a cylinder, and instruct pupils to find another shape which “is a bit like this one”. Ask pupils to explain their reasoning.

Assessment guidance: Practical work, carried out in small groups, provides the most reliable method of assessing whether pupils have met this criterion. Teachers should assess pupils based, not just on their answers, but on the reasoning they use to reach their answers, for example, in question 4, a pupil may choose a cone because “it has a circle too”. When selecting shapes, careful attention should be paid to providing plausible distractors to allow assessment of reasoning. Pupils may use informal language, especially when discussing plausible distractors, for example, the shape presented in question 3 could be a parallelogram, which pupils could describe as being “a bit like a rectangle, but squashed.” Ask pupils to explain why they chose that one.

1G–2 Compose 2D and 3D shapes from smaller shapes

Compose 2D and 3D shapes from smaller shapes to match an example, including manipulating shapes to place them in particular orientations.

1G–2 Teaching guidance

The ability to compose and decompose shapes, and see shapes within shape, is a skill which runs through to key stage 3 and key stage 4, and beyond. In year 1, it is vital that pupils work practically, exploring shapes (for example, shapes cut from card, pattern blocks and tangrams) and putting them together to make new shapes.

Pupils must be able to arrange 2D shapes to match an example compound shape. To begin with, the constituent shapes in a given example image should be the same size and colour as the actual shapes that pupils are using. This allows pupils to begin by laying the pieces over the example image, rotating individual pieces to match the exemplars. By the end of year 1, though, pupils should be able to copy a pattern block picture, and make a good attempt at copying a tangram picture, without overlaying the pieces on the example.

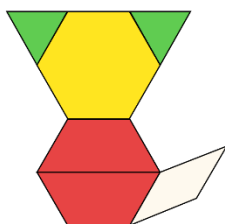

Figure 37: example pattern block picture



Figure 38: example tangram picture

Tangrams are more challenging to complete than pattern block pictures because:

- they contain several different-sized triangles, which pupils must distinguish from one another to complete the task
- placement of the parallelogram may require pupils to turn it over rather than just rotate it

Pupils must also be able to arrange 3D shapes to match an example compound shape, for example joining a given number of multilink blocks to match an example. As a first step pupils can each make their own shape from a given number of blocks, and then compare the different shapes that have been made. Comparing compound shapes, and identifying the ones that are the same, will require pupils to rotate the shapes in various directions, and provides an opportunity to develop spatial language including: left, right, top, middle, bottom, on top of, below, in front of, behind and between.

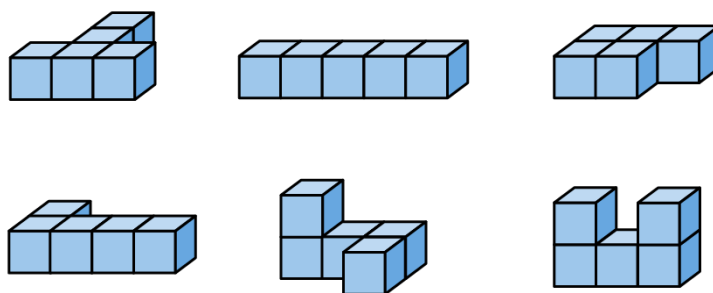

Figure 39: example compound 3D shapes composed of cubes

Pupils must also learn to copy compound shapes composed of other 3D shapes, including cuboids, cylinders, spheres and pyramids.

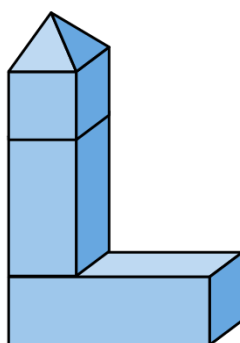

Figure 40: example compound shape composed of 4 different 3D shapes

Making connections

In [1AS-1](#), pupils learn to compose and decompose numbers to 10. Here children are using composition and decomposition in the context of shapes, recognising that shapes can be combined to form a larger shape and decomposed to return to the original shapes.

1G–2 Example assessment questions

1. Task: Give each pupil some multilink cubes. Present pupils with a shape composed of multilink cubes and ask them to copy it.
2. Task: Give each pupils some pattern block pieces. Present pupils with a pattern block picture and ask them to copy it.
3. Task: Give each pupil some building blocks. Build a tower from different-shaped building blocks, then ask pupils to copy it .
4. Task: Give each pupil a set of identical 2D shapes (for example, equilateral triangles of equal size). Make a pattern from the set of identical shapes and ask pupils to copy it.

Assessment guidance: Practical work, carried out in small groups, provides the most reliable method of assessing whether pupils have met this criterion. Teachers should carefully watch pupils to assess their ability to rotate shapes to match those within the patterns, pictures and arrangements, and to place shapes relative to other shapes.

Calculation and fluency

1NF–1 Fluently add and subtract within 10

Develop fluency in addition and subtraction facts within 10.

The main addition and subtraction calculation focus in year 1 is developing fluency in additive facts within 10, as outlined in the [1NF–1 Teaching guidance](#)

Fluency in these facts allows pupils to more easily master addition and subtraction with 2-digit numbers in year 2, and underpins all future additive calculation. Pupils should practise carrying out addition and subtraction calculations, and working with equations in different forms, such as those below, until they achieve automaticity. Pupils should begin to recognise the inverse relationship between addition and subtraction, and use this to calculate. For example, if a pupil knows $6 + 4 = 10$, then they should be able to reason that $10 - 4 = 6$ and $10 - 6 = 4$.

Pupils should also be expected to solve contextual addition and subtraction calculations with the 4 structures described in **1AS-2** (aggregation, partitioning, augmentation and reduction), for calculation within 10.

$5 + 2 = \square$

$6 + 4 = \square$

$\square = 1 + 8$

$\square = 3 + 4$

$5 + \square = 8$

$\square + 1 = 7$

$6 = \square + 2$

$10 = 5 + \square$

$8 - 7 = \square$

$7 - 2 = \square$

$6 - 3 = \square$

$\square = 9 - 5$

$\square - 3 = 4$

$9 - \square = 7$

$3 = \square - 5$

$2 = 10 - \square$

Pupils will need extensive practice, throughout the year, to achieve the fluency required to meet this criterion.

1NF-2 Count forwards and backwards in multiples of 2, 5 and 10

Count forwards and backwards in multiples of 2, 5 and 10, beginning with any multiple, and count forwards and backwards through the odd numbers.

Pupils must be fluent in counting in multiples of 2, 5 and 10 by the end of year 1. Although this is the basis of multiplication and division by 2, 5, and 10, pupils do not need to be introduced to the words ‘multiplication’ and ‘division’ or to the multiplication and division symbols (\times and \div) in year 1, and are not expected to solve calculations presented as written equations. However, through skip counting (using practical resources, images such as number lines, or their fingers) pupils should begin to solve contextual multiplication and quotitive division problems, involving groups of 2, 5 or 10, for example:

- “I have four 5p coins. How much money do I have altogether?”
- “There are 10 apples in each bag. How many bags do I need to have 60 apples?”

Pupils will need extensive practice, throughout the year, to achieve the fluency required to meet this criterion.

Year 2 guidance

Ready-to-progress criteria

Year 1 conceptual prerequisites	Year 2 ready-to-progress criteria	Future applications
<p>Know that 10 ones are equivalent to 1 ten.</p> <p>Know that multiples of 10 are made up from a number of tens, for example, 50 is 5 tens.</p>	<p><u>2NPV-1</u> Recognise the place value of each digit in two-digit numbers, and compose and decompose two-digit numbers using standard and non-standard partitioning.</p>	<p>Compare and order numbers.</p> <p>Add and subtract using mental and formal written methods.</p>
<p>Place the numbers 1 to 9 on a marked, but unlabelled, 0 to 10 number line.</p> <p>Estimate the position of the numbers 1 to 9 on an unmarked 0 to 10 number line.</p> <p>Count forwards and backwards to and from 100.</p>	<p><u>2NPV-2</u> Reason about the location of any two-digit number in the linear number system, including identifying the previous and next multiple of 10.</p>	<p>Compare and order numbers.</p> <p>Round whole numbers.</p> <p>Subtract ones from a multiple of 10, for example:</p> $30 - 3 = 27$
<p>Develop fluency in addition and subtraction facts within 10.</p>	<p><u>2NF-1</u> Secure fluency in addition and subtraction facts within 10, through continued practice.</p>	<p>All future additive calculation.</p> <p>Add within a column during columnar addition when the column sums to less than 10 (no regrouping).</p> <p>Subtract within a column during columnar subtraction when the minuend of the column is larger than the subtrahend (no exchanging).</p>

Year 1 conceptual prerequisites	Year 2 ready-to-progress criteria	Future applications
<p>Learn and use number bonds to 10, for example:</p> $8 + ? = 10$ <p>Partition numbers within 10, for example:</p> $5 = 2 + 3$	<p>2AS-1 Add and subtract across 10, for example:</p> $8 + 5 = 13$ $13 - 5 = 8$	<p>Add and subtract within 100: add and subtract any 2 two-digit numbers, where the ones sum to 10 or more, for example:</p> $26 + 37 = 63$ <p>Use knowledge of unitising to add and subtract across other boundaries, for example:</p> $1.3 - 0.5 = 0.8$ <p>Add within a column during columnar addition when the column sums to more than 10 (regrouping), for example, for:</p> $126 + 148$ <p>Subtract within a column during columnar subtraction when the minuend of the column is smaller than the subtrahend (exchanging), for example, for:</p> $453 - 124$
<p>Solve missing addend problems within 10, for example:</p> $4 + \square = 10$	<p>2AS-2 Recognise the subtraction structure of 'difference' and answer questions of the form, "How many more...?".</p>	<p>Solve contextual subtraction problems for all three subtraction structures (reduction, partitioning and difference) and combining with other operations.</p>
<p>Add and subtract within 10, for example:</p> $6 + 3 = 9$ $6 - 2 = 4$ <p>Know that a multiple of 10 is made up from a number of tens, for example, 50 is 5 tens.</p>	<p>2AS-3 Add and subtract within 100 by applying related one-digit addition and subtraction facts: add and subtract only ones or only tens to/from a two-digit number.</p>	<p>Add and subtract using mental and formal written methods.</p>

Year 1 conceptual prerequisites	Year 2 ready-to-progress criteria	Future applications
<p>Add and subtract within 10. Know that a multiple of 10 is made up from a number of tens, for example, 50 is 5 tens.</p>	<p>2AS-4 Add and subtract within 100 by applying related one-digit addition and subtraction facts: add and subtract any 2 two-digit numbers.</p>	<p>Add and subtract numbers greater than 100, recognising unitising, for example: $32 \text{ ones} + 23 \text{ ones} = 55 \text{ ones}$ so $32 \text{ tens} + 23 \text{ tens} = 55 \text{ tens}$ $320 + 230 = 550$</p>
<p>Count in multiples of 2, 5 and 10.</p>	<p>2MD-1 Recognise repeated addition contexts, representing them with multiplication equations and calculating the product, within the 2, 5 and 10 multiplication tables.</p>	<p>Use multiplication to represent repeated addition contexts for other group sizes. Memorise multiplication tables.</p>
<p>Count in multiples of 2, 5 and 10 to find how many groups of 2, 5 or 10 there are in a particular quantity, set in everyday contexts.</p>	<p>2MD-2 Relate grouping problems where the number of groups is unknown to multiplication equations with a missing factor, and to division equations (quotitive division).</p>	<p>Division with other divisors.</p>
<p>Recognise common 2D and 3D shapes presented in different orientations.</p>	<p>2G-1 Use precise language to describe the properties of 2D and 3D shapes, and compare shapes by reasoning about similarities and differences in properties.</p>	<p>Identify similar shapes. Describe and compare angles. Draw polygons by joining marked points Identify parallel and perpendicular sides. Identify regular polygons Find the perimeter of regular and irregular polygons. Compare areas and calculate the area of rectangles (including squares) using standard units. Compare areas and calculate the area of rectangles (including squares) using standard units.</p>

2NPV-1 Place value in two-digit numbers

Recognise the place value of each digit in two-digit numbers, and compose and decompose two-digit numbers using standard and non-standard partitioning.

2NPV-1 Teaching guidance

Pupils need to be able to connect the way two-digit numbers are written in numerals to their value. They should demonstrate their reasoning using full sentences.

Language focus

“This is the number 42. The 4 shows we have 4 groups of ten. The 2 shows we have 2 extra ones.”

Pupils should recognise that 42, for example, can be composed either of 42 ones, or of 4 tens and 2 ones. They should be able to group objects into tens, with some left over ones, to count efficiently and to demonstrate an understanding of the number. Pupils need to be capable of identifying the total quantity in different representations of groups of ten and additional ones. Within these representations the relative positions of the tens and the ones should be varied.

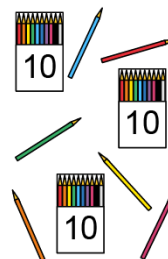
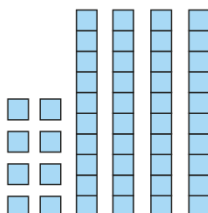
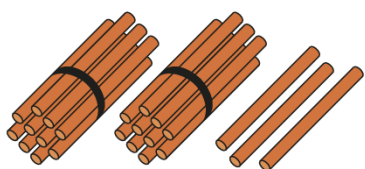
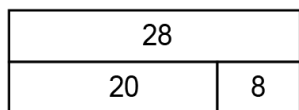
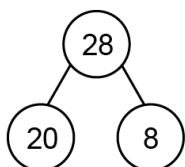

Figure 41: varied representations of two-digit numbers as groups of ten and additional ones

Pupils need to be able to partition two-digit numbers into tens and ones parts, and represent this using diagrams, and addition and subtraction equations.



$$20 + 8 = 28 \quad 28 - 20 = 8$$

$$8 + 20 = 28 \quad 28 - 8 = 20$$

$$28 = 20 + 8 \quad 8 = 28 - 20$$

$$28 = 8 + 20 \quad 20 = 28 - 8$$

Figure 42: partitioning 28 into 20 and 8

It is also important for pupils to be able to think flexibly about number, learning to:

- partition into a multiple of ten and another two-digit number, in different ways (for example, 68 can be partitioned into 50 and 18, into 40 and 28, and so on)
- partition into a two-digit number and a one-digit number, in different ways (for example, 68 can be partitioned into 67 and 1, 66 and 2, and so on)

Making connections

Learning about place value should include connections with addition and subtraction in the form of partitioning two-digit numbers according to tens and ones, and writing associated additive equations. Pupils should also partition two-digit numbers in ways other than according to place value to prepare them to solve addition and subtraction calculations involving two-digit numbers.

2NPV-1 Example assessment questions

1. Daisy has used 10cm rods and 1cm cubes to measure the length of this toy boat. How long is the boat?

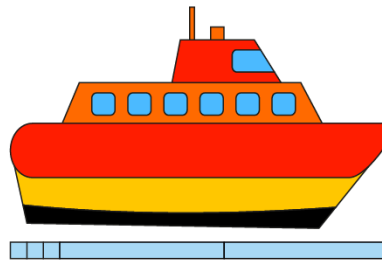

2. What is the total value of these coins?



3. Monika watches a cartoon for 20 minutes and a news programme for 5 minutes. How long does she watch television for?
4. Fill in the missing numbers.
 $47 - \square = 7$ $\square = 8 + 60$
5. Jed collects 38 conkers and gives 8 of them to Dylan. How many conkers does Jed have left?

2NPV–2 Two-digit numbers in the linear number system

Reason about the location of any two-digit number in the linear number system, including identifying the previous and next multiple of 10.

2NPV–2 Teaching guidance

Pupils need to be able to identify or place two-digit numbers on marked number lines. They should use efficient strategies and appropriate reasoning, including working backwards from a multiple of 10.

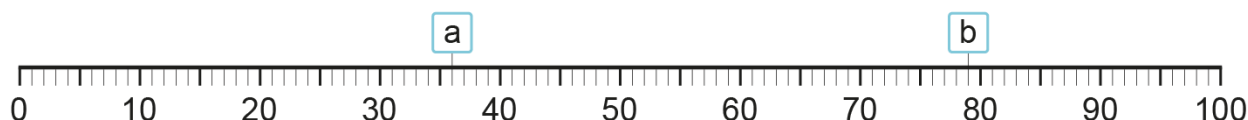

Figure 43: identifying 36 and 79 on a marked 0 to 100 number line

Language focus

“*a* is 36 because it is one more than the midpoint of 35.”

“*b* is 79 because it is one less than 80.”

Pupils should also be able to estimate the value or position of two-digit numbers on unmarked number lines, using appropriate proportional reasoning, rather than counting on from a start point or back from an end point. For example, here pupils should reason: “60 is about *here* on the number line because it’s just over half way”.

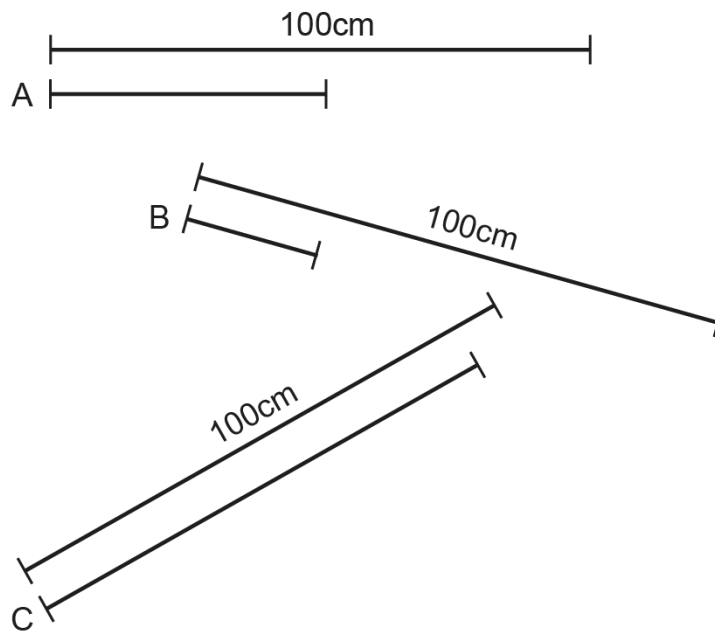

Figure 44: placing 60 on an unmarked 0 to 100 number line

To prepare for future work on rounding, pupils should also learn to identify which 2 multiples of 10 a given two-digit number is between.

2NPV-2 Example assessment questions

1. Look at lines A, B and C. Estimate how long they are by comparing them to the 100cm lines?



2. The table shows the results of a survey which asked pupils to choose their favourite sport. Which sports were chosen by between 20 and 30 pupils?

Favourite sport	Number of pupils
netball	24
basketball	19
tennis	12
football	32
hockey	6
swimming	28
gymnastics	15

3. Sophie thinks of a number. She says, "My number is between 40 and 50. It has 7 in the ones place." What is Sophie's number?
4. Estimate the position of 60 on this number line:

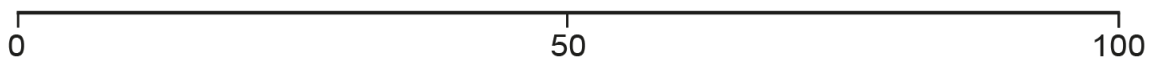

5. The bar chart shows the number of pupils in each year-group in a school. How many pupils are in year 1?

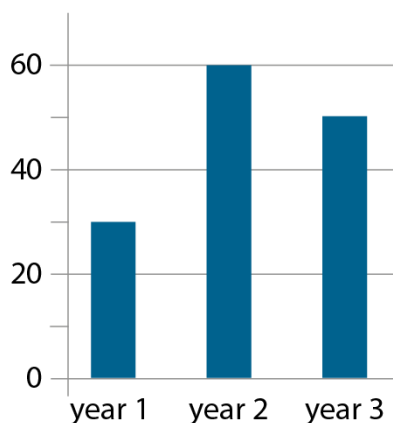

6. Fill in the missing numbers.

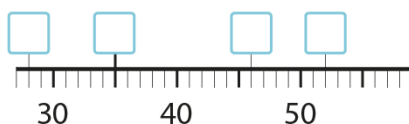

2NF–1 Fluently add and subtract within 10

Secure fluency in addition and subtraction facts within 10, through continued practice.

2NF–1 Teaching guidance

In year 1, pupils should have learnt to add and subtract fluently within 10 ([1NF–1](#)). However, pupils may not still be fluent by the beginning of year 2, so this fluency should now be secured and maintained. Pupils should practise additive calculation within 10 until they have automatic recall of the additive facts. Fluency in these facts is required for pupils to succeed with addition and subtraction across 10 ([2AS–1](#)) and for additive calculation with larger numbers ([2AS–3](#) and [2AS–4](#)).

The 66 addition facts within 10 are shown on the grid below. The number of addition facts to be learnt is reduced when commutativity is applied and pupils recognise that $3 + 2$, for example, is the same as $2 + 3$. Pupils must also have automatic recall of the corresponding subtraction facts, for example $5 - 3$ and $5 - 2$.

+	0	1	2	3	4	5	6	7	8	9	10
0	0+0	0+1	0+2	0+3	0+4	0+5	0+6	0+7	0+8	0+9	0+10
1	1+0	1+1	1+2	1+3	1+4	1+5	1+6	1+7	1+8	1+9	
2	2+0	2+1	2+2	2+3	2+4	2+5	2+6	2+7	2+8		
3	3+0	3+1	3+2	3+3	3+4	3+5	3+6	3+7			
4	4+0	4+1	4+2	4+3	4+4	4+5	4+6				
5	5+0	5+1	5+2	5+3	5+4	5+5					
6	6+0	6+1	6+2	6+3	6+4						
7	7+0	7+1	7+2	7+3							
8	8+0	8+1	8+2								
9	9+0	9+1									
10	10+0										

Making connections

Fluency in these addition and subtraction facts is required for addition and subtraction across 10 ([2AS-1](#)) and for additive calculation with larger numbers ([2AS-3](#) and [2AS-4](#)).

2NF-1 Assessment guidance

Assessment guidance: For pupils to have met criterion **2NF-1**, they need to be able to add and subtract within 10 without counting forwards or backwards in ones on their fingers, on a number line or in their heads. Pupils need to be able to automatically recall the facts. Teachers should assess pupils in small groups – simply providing the correct answers to calculations in a written test does not demonstrate that a pupil has met the criterion.

2AS–1 Add and subtract across 10

Add and subtract across 10, for example:

$$8+5=13$$

$$13-5=8$$

2AS–1 Teaching guidance

Pupils need to have a strategy for confidently and fluently carrying out calculations such as:

- $7+5=12$
- $15-9=6$

For both addition and subtraction across 10, tens frames and partitioning diagrams can be used to support pupils as they learn about these strategies.

First, pupils should learn to add three one-digit numbers by making 10, for example, $7+3+2=10+2$. They can then relate this to addition of two numbers across 10, by partitioning one of the addends, for example $7+5=7+3+2$.

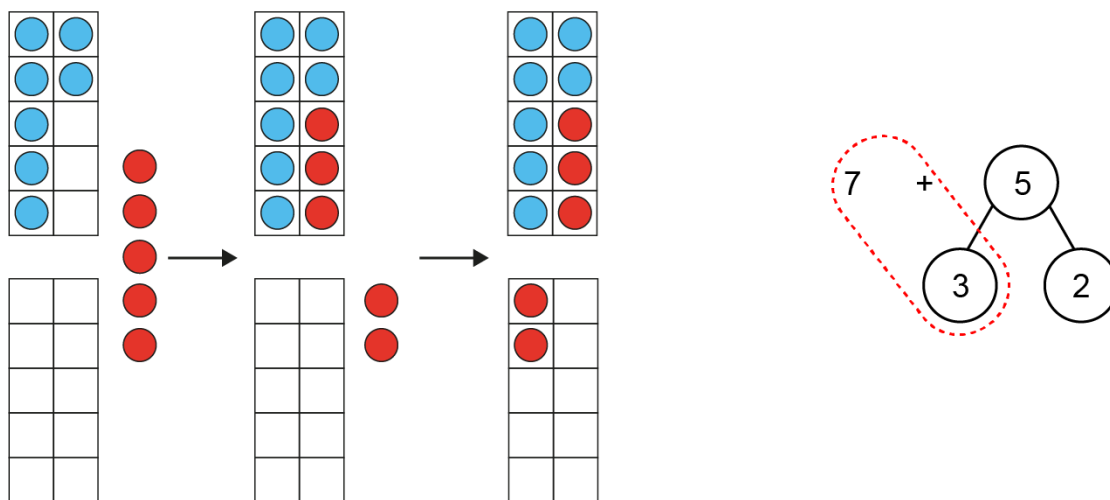

Figure 45: tens frames with counters, and a partitioning diagram, showing $7+5=12$

Pupils can subtract across 10 by using:

- the 'subtracting through 10' strategy (partitioning the subtrahend) – part of the subtrahend is subtracted to reach 10, then the rest of the subtrahend is subtracted from 10

or

- the 'subtracting from 10' strategy (partitioning the minuend) – the subtrahend is subtracted from 10, then the difference between the minuend and 10 is added

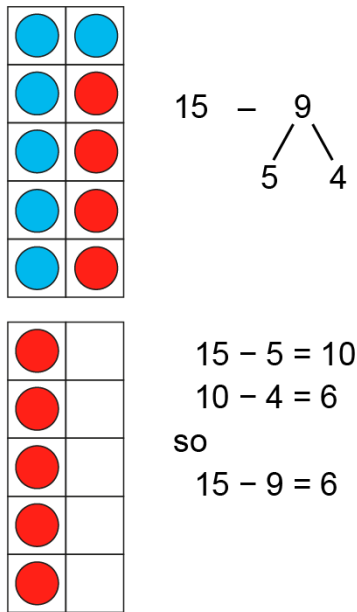

Figure 46: using the 'subtracting through 10' strategy to calculate 15 minus 9

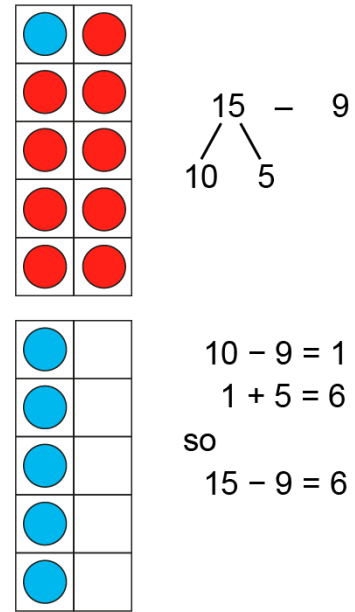

Figure 47: using the 'subtracting from 10' strategy to calculate 15 minus 9

You can find out more about fluency and recording for these calculations here in the calculation and fluency section: [2AS-1](#)

Making connections

This criterion depends on criterion [2NPV-1](#) where, as part of composing numbers according to place value, pupils learnt to:

- add a ten and some ones to make numbers between 11 and 19, for example:
 $10 + 3 = 13$
- subtract the ones from a number between 11 and 19 to make 10, for example:
 $13 - 3 = 10$

2AS–1 Example assessment questions

1. Amisha spends £5 on a book and £8 on a T-shirt. How much does she spend altogether?
2. I have a 15cm length of ribbon. I cut off 6cm. How much ribbon is left?
3. I have 17 pencils. 9 have been sharpened. How many have not been sharpened?
4. A garden fence was 8m long. Then the gardener added 7 more metres of fencing. How long is the garden fence now?

Assessment guidance: For pupils to have met criterion **2AS–1**, they need to be able to add and subtract across 10 without counting forwards or backwards in ones on their fingers, on a number line or in their heads. Teachers should assess pupils in small groups – simply providing the correct answers to the example questions above does not demonstrate that a pupil has met the criterion. The full set of addition and subtraction facts which children need to be fluent in is shown in the appendix.

2AS–2 Solve comparative addition and difference problems

Recognise the subtraction structure of ‘difference’ and answer questions of the form, “How many more...?”.

2AS–2 Teaching guidance

Pupils need to be able to solve problems with missing addends using known number facts or calculation strategies, for example:

$$19 + \square = 25$$

Pupils need to be able to recognise problems about difference, and relate them to subtraction. For example, they should understand that they need to calculate $3 + \square = 5$ or $5 - 3 = \square$ to solve the problem: There are 5 red cars and 3 blue cars. What is the difference between the number of red cars and blue cars?

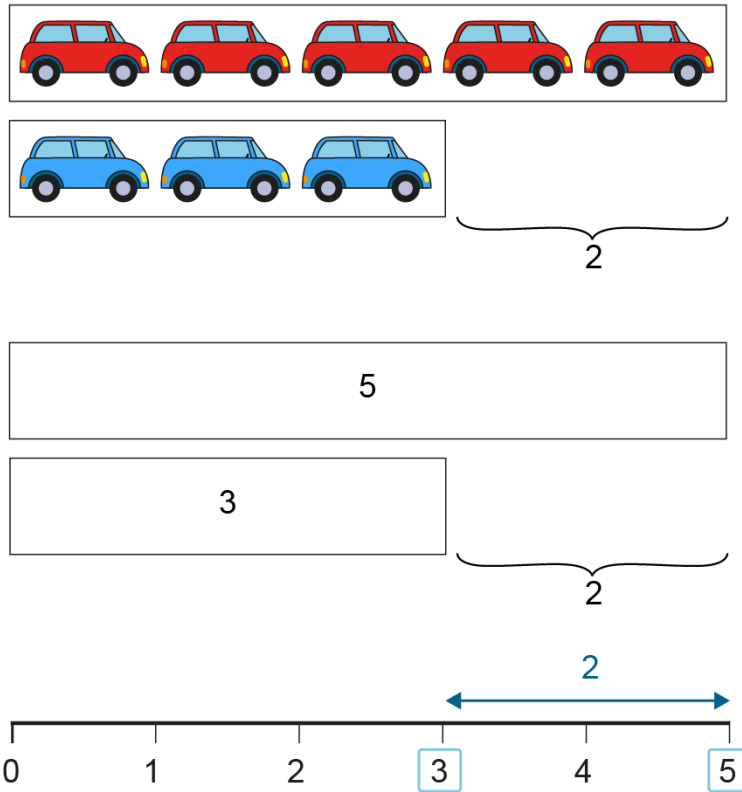
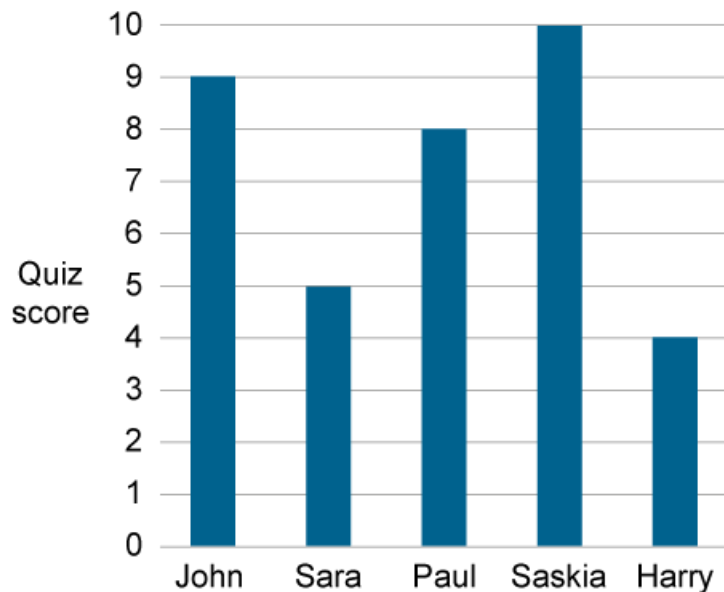

Figure 48: finding the difference – bar model and number line

Pupils should be able to recognise contextual problems involving finding a difference, phrased as ‘find the difference’, ‘how many more’ and ‘how many fewer’, such as those shown in the [2AS-2](#) below. Pupils may solve these problems by relating them to either a missing addend equation or to subtraction, applying known facts and strategies.

2AS–2 Example assessment questions

1. The bar chart shows how many points some pupils scored in a quiz.



- How many more points did John score than Sara?
 - How many fewer points did Harry score than Saskia?
 - What is the difference between Saskia's score and Paul's score?
- I have £19 and want to buy a game which costs £25. How much more money do I need?
 - Felicity has 34 marbles and Dan has 30 marbles. What is the difference between the number of marbles they have?
 - It takes me 20 minutes to walk to school. So far I have been walking for 12 minutes. How much longer do I have to walk for?
 - Liam is 90cm tall. Karim is 80cm tall. How much taller is Liam than Karim?

2AS–3 Add and subtract within 100 – part 1

Add and subtract within 100 by applying related one-digit addition and subtraction facts: add and subtract only ones or only tens to/from a two-digit number.

2AS–3 Teaching guidance

Pupils should be able to apply known one-digit additive facts to:

- adding and subtracting 2 multiples of ten
(for example, $40 + 30 = 70$ and $70 - 30 = 40$)
- adding and subtracting ones to/from a two-digit number
(for example, $64 + 3 = 67$ and $67 - 3 = 64$)
- adding and subtracting multiples of ten to/from a two-digit number
(for example, $45 + 30 = 75$ and $75 - 30 = 45$)
- the special case of subtracting ones from a multiple of ten, by using complements of 10
(for example $30 - 3 = 27$)

Tens frames, Dienes and partitioning diagrams can be used to support pupils as they learn how to relate these calculations to one-digit calculations.

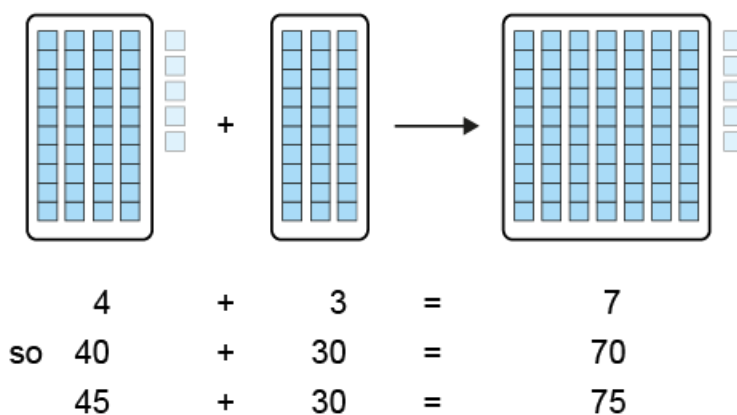

Figure 49: Dienes and equations to support adding a multiple of 10 to a two-digit number

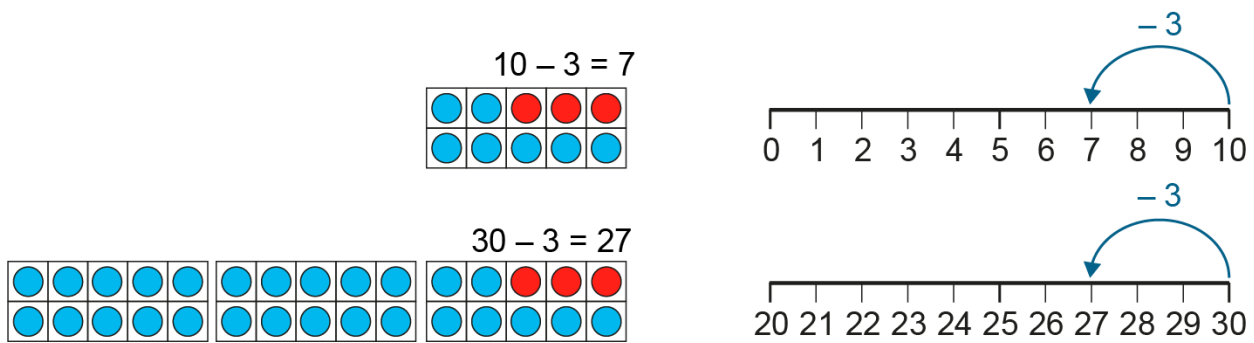

Figure 50: tens frames with counters, and number lines, to support subtracting ones from a multiple of 10

Throughout, pupils should use spoken language to demonstrate their reasoning.

Language focus

“4 plus 3 is equal to 7. So 4 tens and plus 3 tens is equal to 7 tens.”

“10 minus 3 is equal to 7. So 30 minus 3 is equal to 27.”

Pupils should also be able to apply strategies for addition or subtraction across 10, from above, to addition or subtraction bridging a multiple of 10.

You can find out more about fluency and recording for all of these calculation types here in the calculation and fluency section: [2AS-3](#)

Making connections

Learning to subtract ones from a multiple of 10 should be connected to pupils’ understanding of the location of two-digit numbers in the linear number system, for example pupils understand that 27 is 3 ‘before’ 30, so $30 - 3 = 27$.

2AS–3 Example assessment questions

1. A bouncy ball costs 60p. Circle the coins which you could use to pay for it. Is there more than one answer?



2. Sophie's book has 50 pages. So far she has read 9 pages. How many more pages does Sophie have left to read?

3.

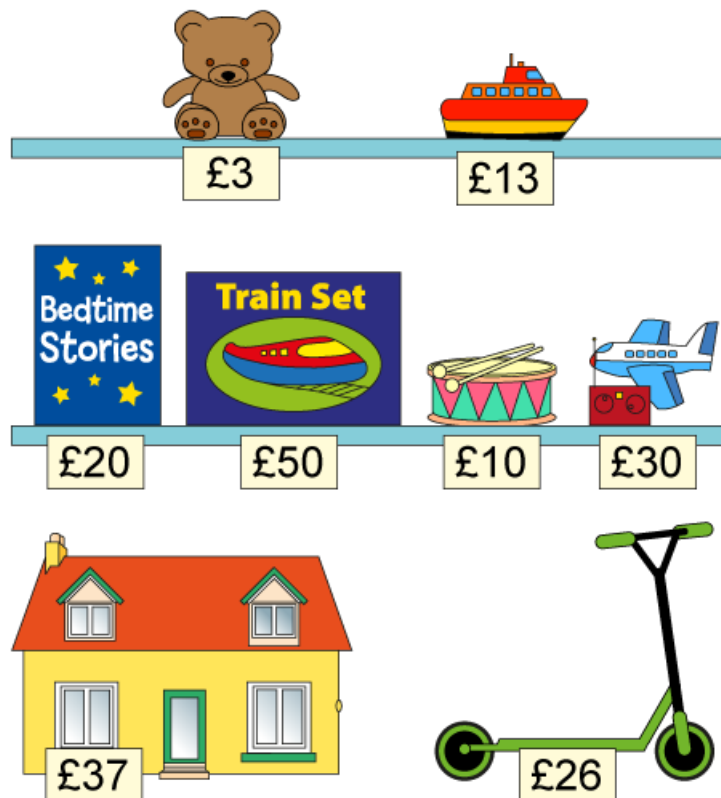

What is the total cost of:

- a. the bedtime stories book and the train set?
- b. the doll's house and the plane?
- c. the scooter and the teddy?
- d. the boat, the train set and the drum?

4. Oak class raise £68 for their class fund. They spend £40 on new paints. How much money do they have left?

Assessment guidance: Simply providing the correct answers to the example questions above does not demonstrate that pupils have met criterion **2AS-3**. For pupils to meet the criterion, they must be able to use known addition and subtraction facts within 10 to solve the calculations efficiently. Before using the questions above, assess pupils in small groups by watching how they solve calculations such as:

$40 + 30$

$31 + 5$

$20 + 59$

$46 + 4$

$90 - 40$

$48 - 6$

$72 - 30$

$80 - 3$

Language focus

"I know that 2 plus 5 is equal to 7, so 20 plus 50 is equal to 70. There are 9 ones as well, so 20 plus 59 is equal to 79."

Pupils who are using extensive written notes (for example, sketching 'jumping back' in tens on a number line as a way to solve $90 - 40$) have not yet met criterion **2AS-3**.

2AS–4 Add and subtract within 100 – part 2

Add and subtract within 100 by applying related one-digit addition and subtraction facts: add and subtract any 2 two-digit numbers.

2AS–4 Teaching guidance

As for **2AS–3**, Dienes and partitioning diagrams can be used to support pupils as they learn about strategies for carrying out these calculations.

To add 2 two-digit numbers, pupils need to combine one-digit addition facts with their understanding of two-digit place value. Pupils should first learn to add 2 multiples of ten and 2 ones before moving on to the addition of 2 two-digit numbers, for example:

- $40 + 20 + 5 + 3 = 60 + 8 = 68$
- $40 + 5 + 20 + 3 = 60 + 8 = 68$
- $45 + 23 = 60 + 8 = 68$

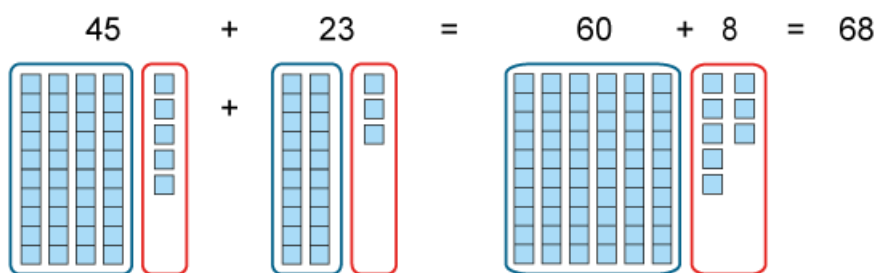

Figure 51: Dienes and an equation to support adding 2 two-digit numbers

Language focus

“First I partition both numbers. Then I add the tens. Then I add the ones. Then I combine all of the tens and all of the ones.”

Pupils can then learn to be more efficient, by partitioning just one addend, for example:

$$\begin{aligned} 45 + 23 &= 45 + 20 + 3 \\ &= 65 + 3 \end{aligned}$$

When pupils learn to subtract one two-digit number from another, the progression is similar to that for addition. Pupils can first learn to subtract a multiple of ten and some ones from a two-digit number, and then connect this to the subtraction of one two-digit number from another, for example:

- $45 - 20 - 3 = 25 - 3$
= 22

- $45 - 3 - 20 = 42 - 20$
= 22

- $45 - 23 = 45 - 20 - 3$
= 25 - 3
= 22

or

- $45 - 23 = 45 - 3 - 20$
= 42 - 20
= 22

There is an important difference compared to the addition strategy: pupils should not partition both two-digit numbers for subtraction as this can lead to errors, or calculations involving negative numbers, when bridging a multiple of 10, for example:

- $63 - 17 \neq 60 - 10 + 7 - 3$
- $63 - 17 = 60 - 10 + 3 - 7$

You can find out more about fluency and recording for addition and subtraction of two-digit numbers here in the calculation and fluency section: [2AS-4](#)

Making connections

Pupils should also be able to apply strategies for addition or subtraction across 10 ([2AS-1](#)) to calculations such as $26 + 37 = 63$ and $63 - 37 = 26$.

2AS–4 Example assessment questions

1.

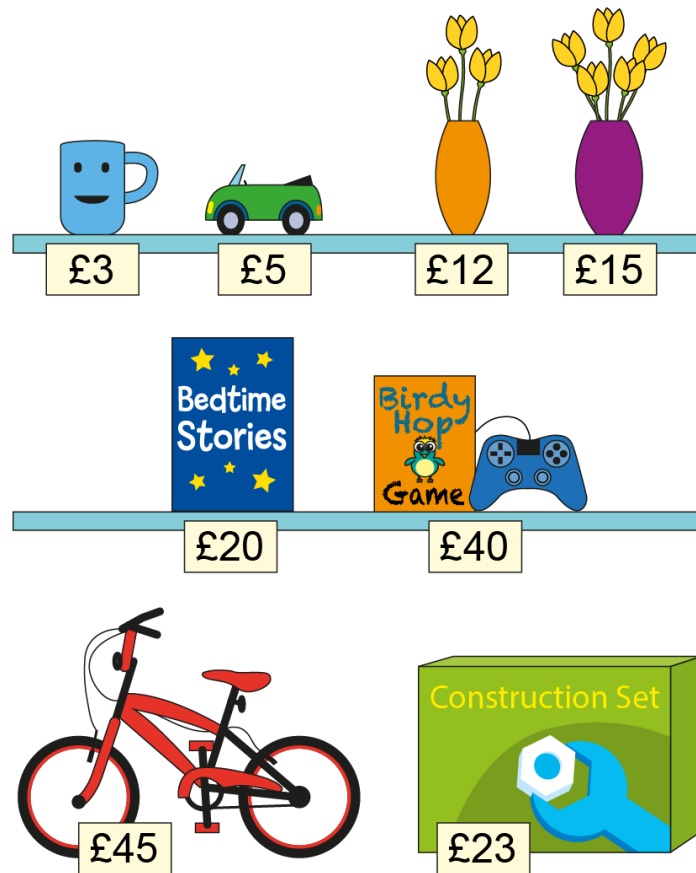

- Daisy spends £32 in the shop. Circle the 2 items she buys.
- What is the total cost of the bicycle and construction set?
- Jalal pays for the bicycle using a £50 note. How much change does he get?
- Yu Yan wants to buy the construction set. She has saved £15. How much more money does Yu Yan need to save?

2MD–1 Multiplication as repeated addition

Recognise repeated addition contexts, representing them with multiplication equations and calculating the product, within the 2, 5 and 10 multiplication tables.

2MD–1 Teaching guidance

Pupils must first be able to recognise equal groups. To better understand and identify equal groups, pupils should initially explore both equal and unequal groups. Pupils should then learn to describe equal groups with words.

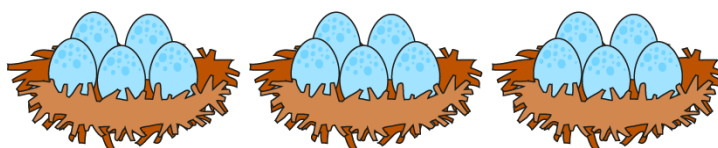

Figure 52: recognising equal groups – 3 groups of 5 eggs

Language focus

“There are 3 equal groups of eggs.”

“There are 5 eggs in each group.”

“There are 3 groups of 5.”

Based on their existing additive knowledge, pupils should be able to represent equal-group contexts with repeated addition expressions, for example $5 + 5 + 5$. They should then learn to write multiplication expressions to represent the same contexts, for example 3×5 . Pupils must be able to explain how each term in a multiplication expression links to the context it represents.

Pupils must also be able to understand equivalence between a repeated addition expression and a multiplication expression: $5 + 5 + 5 = 3 \times 5$.

Pupils should then learn to calculate the total number of items (the product), for contexts based on the 2, 5 and 10 multiplication tables, initially by skip counting. They should be able to write complete multiplication equations, for example $3 \times 5 = 15$, and explain how each term links to the context.

Language focus

“The 3 represents the number of groups.”

“The 5 represents the number of eggs in each group.”

“The 15 represents the total number of eggs.”

Pupils should be able to relate multiplication to situations where the total number of items cannot be seen, for example by representing 3×5 with three 5-value counters.



Figure 53: three 5-value counters

You can find out more about fluency and recording for the 2, 5 and 10 multiplication tables here in the calculation and fluency section: [2MD-1](#).

Making connections

Pupils must be able to write and solve addition problems with 3 or more addends before they can connect repeated addition to multiplication.

2MD-1 Example assessment questions

1. Write these addition expressions as multiplication expressions. The first one has been completed for you.

$$5 + 5 + 5 + 5 + 5 = 5 \times 5$$

$$2 + 2 + 2 + 2 + 2 = \underline{\hspace{2cm}}$$

$$2 + 2 + 2 = \underline{\hspace{2cm}}$$

$$10 + 10 + 10 = \underline{\hspace{2cm}}$$

2. There are 7 year-groups in Winterdale School. Each year-group has 2 classes. How many classes are in the school?
3. Sally buys 3 cinema tickets. Each ticket costs £5. How much does Sally spend? Write the multiplication expression and calculate the cost.

4. There are 10 children sitting at each table in a dining hall. There are 8 tables. How many children are there?
5. The pictogram shows how many socks each child has. How many socks does Asif have?



6. Write a story to go with this equation.

$$6 \times 10 = 60$$

7. Complete the calculations.

$7 \times 5 = \square$

$10 \times 4 = \square$

$9 \times 2 = \square$

2MD–2 Grouping problems: missing factors and division

Relate grouping problems where the number of groups is unknown to multiplication equations with a missing factor, and to division equations (quotitive division).

2MD–2 Teaching guidance

Pupils need to be able to represent problems where the total quantity and group size is known, using multiplication equations with missing factors. For example, “There are 15 biscuits. If I put them into bags of 5, how many bags will I need?” can be represented by the following equation:

$$\square \times 5 = 15$$

Pupils can use skip counting or their emerging 2, 5 and 10 multiplication table fluency to calculate the missing factor.

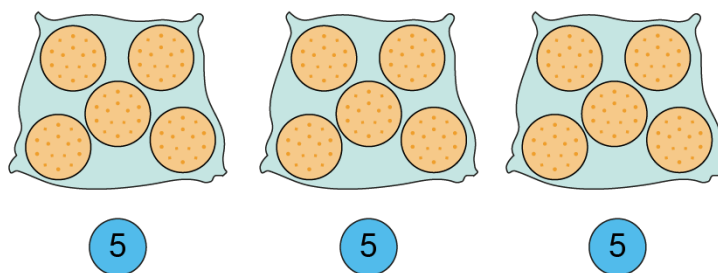

Figure 54: 3 bags of 5 biscuits alongside three 5-value counters

Pupils should then learn that unknown-factor problems can also be represented with division equations (quotitive division), for example, $15 \div 5 = \square$. They should be able to use skip counting or their multiplication-table fluency to find the quotient: $15 \div 5 = 3$.

Pupils should be able to describe how each term in the division equation links to the context and describe the division equation in terms of ‘division into groups’.

Language focus

“The 15 represents the total number of biscuits.”

“The 5 represents the number of biscuits in each bag.”

“The 3 represents the number of bags.”

“15 divided into groups of 5 is equal to 3.”

Pupils also need to be able to solve division calculations that are not set in contexts. They should recognise that they need to skip count in the divisor (2, 5 or 10), or use the associated multiplication fact, to find the quotient. For example, to calculate $60 \div 10$, they can skip count in tens (counting the required number of tens) or apply the fact that $6 \times 10 = 60$.

You can find out more about fluency and recording for division by 2, 5 or 10 here in the calculation and fluency section: [2MD-2](#)

2MD-2 Example assessment questions

- Miss Robinson asked Harry to get 60 apples from the kitchen. The apples come in bags of 10. How many bags does Harry need to get?
- Diego has some 5p coins. He has 40p altogether. How many 5p coins does Diego have?
- The pictogram shows how many socks each child has.



Lena has 8 socks. How would this be represented on the pictogram? Draw it.

- There are 5 balloons in a pack. I need 15 balloons for my party. How many bags should I buy?
- Fill in the missing numbers.

$$\square \times 5 = 30$$

$$50 \div 10 = \square$$

$$2 \times \square = 14$$

2G–1 Describe and compare 2D and 3D shapes

Use precise language to describe the properties of 2D and 3D shapes, and compare shapes by reasoning about similarities and differences in properties.

2G–1 Teaching guidance

Building on **1G–1**, pupils should continue to explore and discuss common 2D and 3D shapes, now extending to include quadrilaterals and other polygons, and cuboids, prisms and cones.

Pupils must now learn to use precise language to describe 2D shapes, including the terms 'sides' and 'vertex'/'vertices'. They should learn to identify the sides of a given 2D shape and to identify a vertex as a point where two sides meet.

Pupils must learn that a polygon is a 2D shape which has only straight sides and then learn to identify a given polygon by counting the number sides (or vertices). Pupils should practise running their finger along each side as they count the sides (or practise touching each vertex as they count the vertices). Later, pupils may mark off the sides or vertices on an image as they count. It is important that they learn to count the sides/vertices accurately, counting each once and only once. Pupils must know that it is the number of sides/vertices that determines the type of polygon, rather than whether the given shape looks like their mental image of a particular polygon. For example, although pupils may informally describe the shape below as "like a square with 2 corners cut off", they should be able to recognise and explain that, because it has 6 straight sides, it is a hexagon.

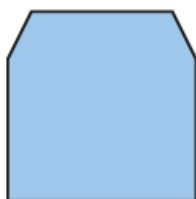

Figure 55: an irregular hexagon

Language focus

"This shape is a hexagon because it has exactly 6 straight sides."

When discussing 3D shapes, pupils should be able to correctly use the terms 'edges', 'vertex'/'vertices' and 'faces'. Pupils need to be able to accurately count the number of edges, vertices and faces for simple 3D shapes, such as a triangular-based pyramid or a cuboid, using sticky paper (if necessary) to keep track of the edges/vertices/faces as they count. Pupils should be able to identify the 2D shapes that make up the faces of 3D

shapes, including identifying pyramids according to the shape of their base ('square-based' and 'triangle-based').

Pupils should gain experience describing and comparing standard and non-standard exemplars of polygons. They should explore shapes (for example, shapes cut from card) rather than only looking at pictures. Examples of irregular polygons should not be restricted to those where every side-length is different and every internal angle is a different size. Examples should include polygons in which:

- some side-lengths are equal
- some internal angles are equal
- there are a variety of sizes of internal angles (acute, right angled, obtuse and/or reflex)
- there are pairs of parallel and perpendicular sides

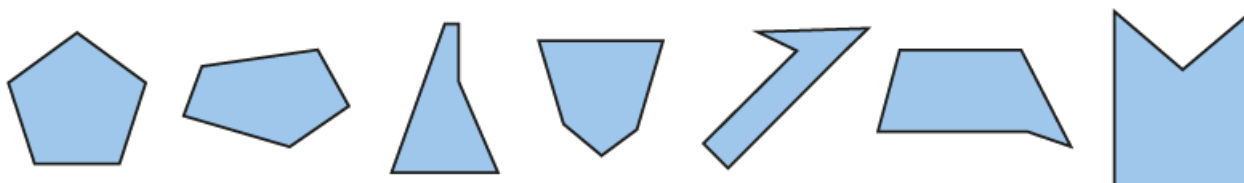

Figure 56: a variety of different pentagons (regular and irregular)

Language focus

"These shapes are all pentagons because they all have exactly 5 straight sides."

Pupils don't need to be able to identify or name angle types or parallel/perpendicular sides in year 2, but it is important that they gain visual experience of them as preparation for identifying and naming them in key stage 2.

In a similar way, pupils should gain experience describing and comparing a wide variety of 3D shapes including cuboids (and cubes), prisms, cones, pyramids, spheres and cylinders. Pupils should explore shapes practically as well as looking at pictures. Pupils should also explore and discuss regular polyhedrons such as octahedrons and dodecahedrons, although year 2 pupils do not need to remember the names of these shapes.

As well as discussing sides and vertices (as a precursor to evaluating perimeter and angle), pupils should begin to use informal language to discuss and compare the space inside 2D shapes (as a precursor to evaluating area). Pupils should be able to reason about the shape and size of the space inside a 2D shape, relative to other 2D shapes, using language such as 'long and thin', 'short and wide', 'larger and 'smaller'.

2G–1 Example assessment questions

1. How many sides does this shape have? What is the name of this shape?

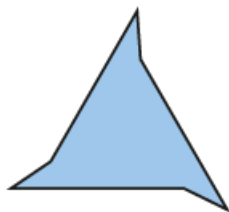

2. Sketch a hexagon. Try to think of a hexagon that will look different to those drawn by other pupils.
3. Task: Lay out a selection of 3D shapes, then instruct pupils to find a shape that has:
- fewer than 5 edges
 - more than 5 faces
 - exactly 1 vertex
 - all faces the same shape
 - no flat faces
 - no straight edges
 - both a square face and a triangular face

4.

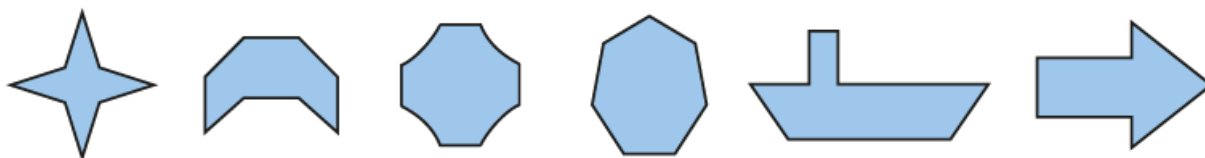

- Circle all of the octagons.
 - Explain why the shapes you have *not* circled are *not* octagons.
5. Task: Present pupils with a cylinder and a cone (the 3D shapes rather than pictures), then instruct pupils to:
- describe something that is the same about the 2 shapes
 - describe something that is different about the 2 shapes
6. Task: Lay out a selection of 3D shapes, then ask pupils to identify all of the shapes that have a square face.

7. Here are 4 rectangles.

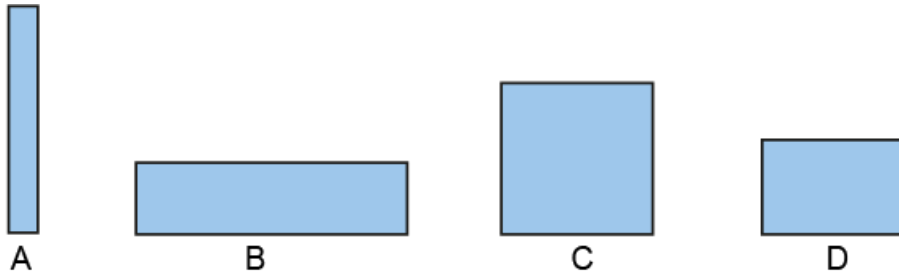

Which do you think is the largest rectangle?

Which do you think is the smallest rectangle?

If each rectangle was a slice of your favourite food, which one would you choose to have?

8. Which of the shapes B to H are exactly the same shape as shape A, but just a different size?

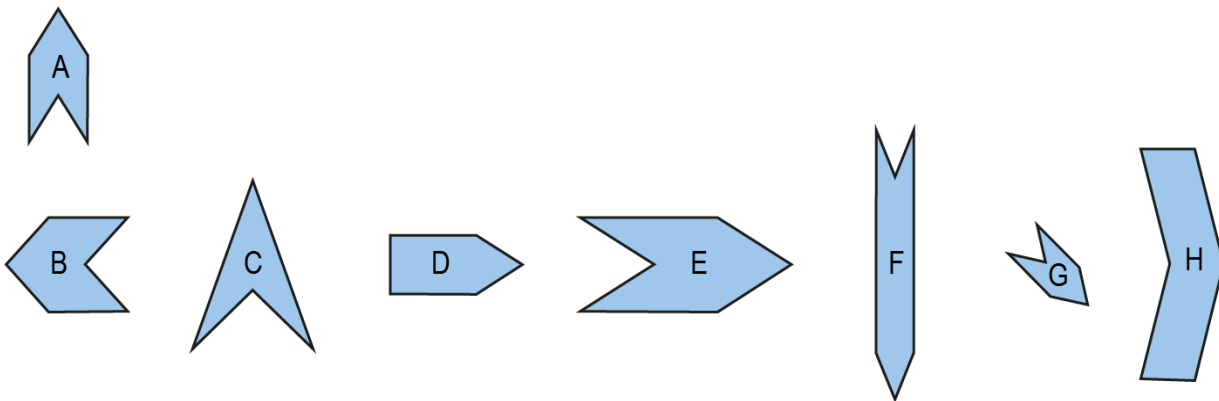

Assessment guidance: Practical work, carried out in small groups, should form part of the assessment of this criterion. For question 3, pupils must be able to name common 3D shapes, but do not need to be able to name every shape they might select to fulfil the required criteria. For questions 7 and 8, assessment should be discussion based – pupils need not necessarily provide a ‘correct’ answer, but should demonstrate an emerging sense of the size and shape of the space within 2D shapes. For question 8, for example, some pupils may say that shape F is the same shape as A but just stretched, and some pupils may say that F is a different shape to A because F is “long and thin” and A is “shorter and fatter”: both of these answers would show that pupils are developing awareness of the overall shape rather than just attending to the number of sides and vertices.

Calculation and fluency

2AS–1 Add and subtract across 10

Add and subtract across 10, for example:

$$8 + 5 = 13$$

$$13 - 5 = 8$$

At first, pupils will use manipulatives, such as tens frames, to understand the strategies for adding and subtracting across 10. However, they should not be using the manipulatives as a tool for finding answers. Pupils should be able to carry out these calculations mentally, using their fluency in complements to 10 and partitioning. Pupils are fluent in these calculations when they no longer rely on extensive written methods, such as equation sequences or partitioning diagrams.

Pupils do not need to memorise all additive facts for adding and subtracting across 10, but they need to be able to recall appropriate doubles (double 6, 7, 8 and 9) and corresponding halves (half of 12, 14, 16 and 18), and use these known facts for calculations such as $6 + 6 = 12$ and $18 - 9 = 9$.

Year 2 pupils will need lots of practice to be able to add and subtract across 10 with sufficient fluency to make progress with the year 3 curriculum. They should also continue to practise adding and subtracting within 10.

2AS–3 Add and subtract within 100 – part 1

Add and subtract within 100 by applying related one-digit addition and subtraction facts: add and subtract only ones or only tens to/from a two-digit number

For pupils to become fluent with the strategies for these two-digit additive calculations, as well as having automatic recall of one-digit additive facts, they must also be conceptually fluent with the connections between one-digit facts and two-digit calculations. This conceptual fluency is based on:

- being able to unitise (for example, understanding $40 + 50$ as 4 units of ten + 5 units of ten)
- an understanding of place-value

Pupils should be able to solve these calculations mentally and be able to demonstrate their reasoning either verbally or with manipulatives or drawings. Note that this is different from using manipulatives or drawings to calculate an answer, which pupils should not need to do.

2AS–4 Add and subtract within 100 – part 2

Add and subtract within 100 by applying related one-digit addition and subtraction facts: add and subtract any 2 two-digit numbers

These calculations involve more steps than those in [2AS–3](#). To avoid overload of working memory, pupils should learn how to record the steps using informal written notation or equation sequences, as shown below. This is particularly important for calculations where addition of the ones involves bridging a multiple of 10, as these require a further calculation step.

$\begin{array}{r} 26 \\ 20 \quad 6 \end{array} + \begin{array}{r} 37 \\ 30 \quad 7 \end{array} = 63$ $20 + 30 = 50$ $6 + 7 = 13$ $50 + 13 = 63$ <p>Figure 57: adding 26 and 37 by partitioning both addends</p>	$26 + \begin{array}{r} 37 \\ 30 \quad 7 \end{array} = 63$ $26 + 30 = 56$ $56 + 7 = 63$ <p>Figure 58: adding 26 and 37 by partitioning one addend</p>
$63 - \begin{array}{r} 17 \\ 10 \quad 7 \end{array} = 46$ $63 - 10 = 53$ $53 - 7 = 46$ <p>Figure 59: subtracting 17 from 63 by subtracting the tens first</p>	$63 - \begin{array}{r} 17 \\ 10 \quad 7 \end{array} = 46$ $63 - 7 = 56$ $56 - 10 = 46$ <p>Figure 60: subtracting 17 from 63 by subtracting the ones first</p>

Pupils do not need to learn formal written methods for addition and subtraction in year 2, but column addition and column subtraction could be used as an alternative way to record two-digit calculations at this stage. For calculations such as $26 + 37$, pupils can begin to think about the 2 quantities arranged in columns under place-value headings of tens and ones. They can use counters or draw dots for support:

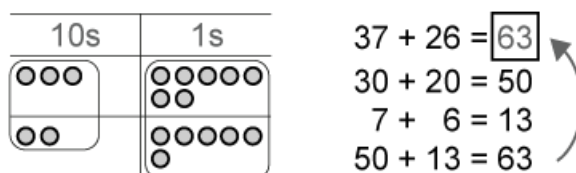

Figure 61: adding 2 two-digit numbers using 10s and 1s columns

2MD–1 Multiplication as repeated addition

Recognise repeated addition contexts, representing them with multiplication equations and calculating the product, within the 2, 5 and 10 multiplication tables.

Pupils must be able to carry out calculations connected to the 2, 5 and 10 multiplication tables, for example:

$$4 \times 5 = \square$$

Pupils should practise skip counting in multiples of 2, 5 and 10, up to 10 groups of each, until they are fluent. When carrying out a multiplication calculation by skip counting, they may keep track of the number of twos, fives or tens using their fingers or by tallying. Pupils may also recite, using the language of the multiplication tables to keep track (1 times 5 is 5, 2 times 5 is 10...). They can also use or draw 2-, 5- or 10-value counters to support them in solving multiplicative problems.

Pupils who are sufficiently fluent in year 2 multiplicative calculations are not reliant on drawing arrays or using number lines as tools to calculate. Pupils should have sufficient conceptual understanding to recognise these as models of multiplication and division, and explain how they link to calculation statements. However they should not need to use them as methods for carrying out calculations.

Pupils need to be able to represent 4 fives (or 5, 4 times) as both 4×5 and 5×4 . They should be able to use commutativity to solve, for example, 2 sevens, using their knowledge of 7 twos.

2MD–2 Grouping problems: missing factors and division

Relate grouping problems where the number of groups is unknown to multiplication equations with a missing factor, and to division equations (quotitive division).

Pupils need to be able to solve missing-factor and division problems connected to the 2, 5 and 10 multiplication tables, for example:

- $\square \times 5 = 20$
- $20 \div 5 = \square$

Pupils should solve division (and missing-factor) problems, such as these, by connecting division to their emerging fluency in skip counting and known multiplication facts. Pupils should not be solving statements such as $20 \div 5$ by sharing 20 between 5 using manipulatives or by drawing dots. Pupils should also not rely on drawing arrays or number lines as tools for calculation.

As for [2MD-1](#), pupils can keep track of the number of twos, fives or tens using their fingers or by tallying. They may also recite, using the language of the multiplication tables, or draw 2-, 5- or 10-value counters. Eventually pupils should be fluent in isolated multiplication facts (for example, 4 fives are 20) and use these to solve missing-factor multiplication problems and division problems.

Year 3 guidance

Ready-to-progress criteria

Year 2 conceptual prerequisite	Year 3 ready-to-progress criteria	Future applications
<p>Know that 10 ones are equivalent to 1 ten, and that 40 (for example) can be composed from 40 ones or 4 tens.</p> <p>Know how many tens there are in multiples of 10 up to 100.</p>	<p>3NPV-1 Know that 10 tens are equivalent to 1 hundred, and that 100 is 10 times the size of 10; apply this to identify and work out how many 10s there are in other three-digit multiples of 10.</p>	<p>Solve multiplication problems that involve a scaling structure, such as ‘ten times as long’.</p>
<p>Recognise the place value of each digit in <i>two</i>-digit numbers, and compose and decompose <i>two</i>-digit numbers using standard and non-standard partitioning.</p>	<p>3NPV-2 Recognise the place value of each digit in <i>three</i>-digit numbers, and compose and decompose <i>three</i>-digit numbers using standard and non-standard partitioning.</p>	<p>Compare and order numbers.</p> <p>Add and subtract using mental and formal written methods.</p>
<p>Reason about the location of any <i>two</i>-digit number in the linear number system, including identifying the previous and next multiple of 10.</p>	<p>3NPV-3 Reason about the location of any <i>three</i>-digit number in the linear number system, including identifying the previous and next multiple of 100 and 10.</p>	<p>Compare and order numbers.</p> <p>Estimate and approximate to the nearest multiple of 1,000, 100 or 10.</p>
<p>Count in multiples of 2, 5 and 10.</p>	<p>3NPV-4 Divide 100 into 2, 4, 5 and 10 equal parts, and read scales/number lines marked in multiples of 100 with 2, 4, 5 and 10 equal parts.</p>	<p>Read scales on graphs and measuring instruments.</p>

Year 2 conceptual prerequisite	Year 3 ready-to-progress criteria	Future applications
<p>Add and subtract across 10, for example:</p> $8 + 5 = 13$ $13 - 5 = 8$	<p>3NF-1 Secure fluency in addition and subtraction facts that bridge 10, through continued practice.</p>	<p>Add and subtract mentally where digits sum to more than 10, for example:</p> $26 + 37 = 63$ <p>Add and subtract across other powers of 10, without written methods, for example:</p> $1.3 - 0.4 = 0.9$ <p>Add within a column during columnar addition when the column sums to more than 10 (regrouping), for example, for:</p> $126 + 148$ <p>Subtract within a column during columnar subtraction when the minuend of the column is smaller than the subtrahend (exchanging), for example, for:</p> $453 - 124$
<p>Calculate products within the 2, 5 and 10 multiplication tables.</p>	<p>3NF-2 Recall multiplication facts, and corresponding division facts, in the 10, 5, 2, 4 and 8 multiplication tables, and recognise products in these multiplication tables as multiples of the corresponding number.</p>	<p>Use multiplication facts during application of formal written layout.</p> <p>Use division facts during short division and long division.</p>
<p>Automatically recall addition and subtraction facts within 10, and across 10.</p> <p>Unitise in tens: understand that 10 can be thought of as a single unit of 1 ten.</p>	<p>3NF-3 Apply place-value knowledge to known additive and multiplicative number facts (scaling facts by 10), for example:</p> $80 + 60 = 140$ $140 - 60 = 80$ $30 \times 4 = 120$ $120 \div 4 = 30$	<p>Apply place-value knowledge to known additive and multiplicative number facts (scaling facts by 100), for example:</p> $8 + 6 = 14 \text{ and } 14 - 6 = 8$ <p>so</p> $800 + 600 = 1,400$ $1,400 - 600 = 800$ $3 \times 4 = 12 \text{ and } 12 \div 4 = 3$ <p>so</p> $300 \times 4 = 1,200$ $1,200 \div 4 = 300$

Year 2 conceptual prerequisite	Year 3 ready-to-progress criteria	Future applications
<p>Automatically recall number bonds to 9 and to 10.</p> <p>Know that 10 ones are equivalent to 1 ten, and 10 tens are equivalent to 1 hundred.</p>	<p>3AS-1 Calculate complements to 100, for example: $46 + ? = 100$</p>	<p>Calculate complements to other numbers, particularly powers of 10.</p> <p>Calculate how much change is due when paying for an item.</p>
<p>Automatically recall addition and subtraction facts within 10 and across 10.</p> <p>Recognise the place value of each digit in two- and three-digit numbers.</p> <p>Know that 10 ones are equivalent to 1 ten, and 10 tens are equivalent to 1 hundred.</p>	<p>3AS-2 Add and subtract up to three-digit numbers using columnar methods.</p>	<p>Add and subtract other numbers, including four-digits and above, and decimals, using columnar methods.</p>
<p>Have experience with the commutative property of addition, for example, have recognised that $3 + 2$ and $2 + 3$ have the same sum.</p> <p>Be able to write an equation in different ways, for example, $2 + 3 = 5$ and $5 = 2 + 3$</p> <p>Write equations to represent addition and subtraction contexts.</p>	<p>3AS-3 Manipulate the additive relationship: Understand the inverse relationship between addition and subtraction, and how both relate to the part-part-whole structure. Understand and use the commutative property of addition, and understand the related property for subtraction.</p>	<p>All future additive reasoning.</p>
<p>Recognise repeated addition contexts and represent them with multiplication equations.</p> <p>Relate grouping problems where the number of groups is unknown to multiplication equations with a missing factor, and to division equations (quotitive division).</p>	<p>3MD-1 Apply known multiplication and division facts to solve contextual problems with different structures, including quotitive and partitive division.</p>	

Year 2 conceptual prerequisite	Year 3 ready-to-progress criteria	Future applications
	<p>3F-1 Interpret and write proper fractions to represent 1 or several parts of a whole that is divided into equal parts.</p>	<p>Use unit fractions as the basis to understand non-unit fractions, improper fractions and mixed numbers, for example:</p> <p>$\frac{2}{5}$ is 2 one-fifths</p> <p>$\frac{6}{5}$ is 6 one-fifths, so $\frac{6}{5} = 1\frac{1}{5}$</p>
	<p>3F-2 Find unit fractions of quantities using known division facts (multiplication tables fluency).</p>	<p>Apply knowledge of unit fractions to non-unit fractions.</p>
<p>Reason about the location of whole numbers in the linear number system.</p>	<p>3F-3 Reason about the location of any fraction within 1 in the linear number system.</p>	<p>Compare and order fractions.</p>
<p>Automatically recall addition and subtraction facts within 10.</p> <p>Unitise in tens: understand that 10 can be thought of as a single unit of 1 ten, and that these units can be added and subtracted.</p>	<p>3F-4 Add and subtract fractions with the same denominator, within 1.</p>	<p>Add and subtract improper and mixed fractions with the same denominator, including bridging whole numbers.</p>
<p>Recognise standard and non-standard examples of 2D shapes presented in different orientations.</p> <p>Identify similar shapes.</p>	<p>3G-1 Recognise right angles as a property of shape or a description of a turn, and identify right angles in 2D shapes presented in different orientations.</p>	<p>Compare angles.</p> <p>Estimate and measure angles in degrees.</p>
<p>Compose 2D shapes from smaller shapes to match an exemplar, rotating and turning over shapes to place them in specific orientations.</p>	<p>3G-2 Draw polygons by joining marked points, and identify parallel and perpendicular sides.</p>	<p>Find the area or volume of a compound shape by decomposing into constituent shapes.</p> <p>Find the perimeter of regular and irregular polygons.</p>

3NPV–1 Equivalence of 10 hundreds and 1 thousand

Know that 10 tens are equivalent to 1 hundred, and that 100 is 10 times the size of 10; apply this to identify and work out how many 10s there are in other three-digit multiples of 10.

3NPV–1 Teaching guidance

Pupils need to experience:

- what 100 items looks like
- making a unit of 1 hundred out of 10 units of 10, for example using 10 bundles of 10 straws to make 100, or using ten 10-value place-value counters



Figure 62: ten 10-value place-value counters in a tens frame

Language focus

“10 tens is equal to 1 hundred.”

Pupils must then be able to work out how many tens there are in other three-digit multiples of 10.



Figure 63: eighteen 10-value place-value counters in 2 tens frames

Language focus

“18 tens is equal to 10 tens and 8 more tens.”

“10 tens is equal to 100.”

“So 18 tens is equal to 100 and 8 more tens, which is 180.”

The reasoning here can be described as grouping or repeated addition – pupils group or add 10 tens to make 100, then add another group of 8 tens.

Pupils need to be able to apply this reasoning to measures contexts, as shown in the [3NPV-1](#) below. It is important for pupils to understand that there are tens within this new unit of 100, in different contexts.

Pupils should be able to explain that numbers such as 180 and 300 are multiples of 10, because they are each equal to a whole number of tens. They should be able to identify multiples of 10 based on the fact that they have a zero in the ones place.

As well as understanding 100 and other three-digit multiples of 10 in terms of grouping and repeated addition, pupils should begin to describe 100 as 10 times the size of 10.

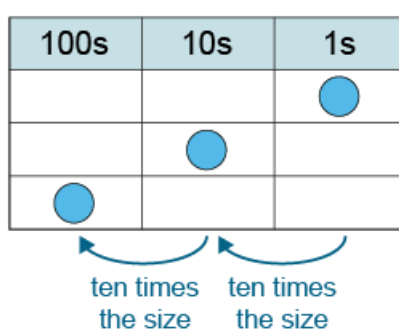

Figure 64: place-value chart illustrating the scaling relationship between ones, tens and hundreds

Language focus

“100 is 10 times the size of 10.”

Making connections

Learning to identify the number of tens in three-digit multiples of 10 should be connected to pupils understanding of multiplication and the grouping structure of division ([2MD-1](#)). Pupils should, for example, be able to represent 180 as 18 tens using the multiplication equations $180 = 18 \times 10$ or $180 = 10 \times 18$, and be able to write the corresponding division equations $180 \div 10 = 18$. In [3MD-1](#) they will learn that $180 \div 10 = 18$ can represent the structure of 180 divided into groups of 10 (quotitive division), as here, and that it can also represent 180 shared into 10 equal shares of 18 each (partitive division).

3NPV–1 Example assessment questions

1. How many 10cm lengths can a 310cm length of ribbon be cut into?
2. The school office sells 52 poppies for 10p each. How much money have they collected altogether?
3. I take 10ml of medicine every day. How many days will a 250ml bottle last?
4. Marek is 2 years old, and has a mass of 10kg. His father's mass is 10 times as much. What is the mass of Marek's father?
5. Janey saves up £100. This is 10 times as much money as her brother has. How much money does her brother have?
6. Circle the numbers that are multiples of 10. Explain your answer.

640 300 105 510 330 409 100 864

3NPV–2 Place value in three-digit numbers

Recognise the place value of each digit in *three*-digit numbers, and compose and decompose *three*-digit numbers using standard and non-standard partitioning.

3NPV–2 Teaching guidance

Pupils should be able to identify the place value of each digit in a three-digit number. They must be able to combine units of ones, tens and hundreds to compose three-digit numbers, and partition three-digit numbers into these units. Pupils need to experience variation in the order of presentation of the units, so that they understand that $40 + 300 + 2$ is equal to 342, not 432.



Figure 65: two representations of the place-value composition of 342

Pupils also need to solve problems relating to subtraction of any single place-value part from the whole number, for example:

$$342 - 300 = \square$$

$$342 - \square = 302$$

As well as being able to partition numbers in the 'standard' way (into individual place-value units), pupils must also be able to partition numbers in 'non-standard' ways, and carry out related addition and subtraction calculations, for example:

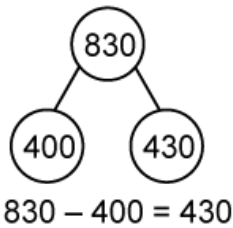

Figure 66: partitioning 830 into 430 and 400

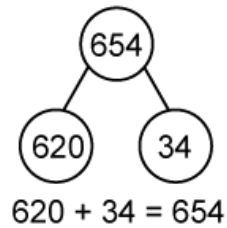
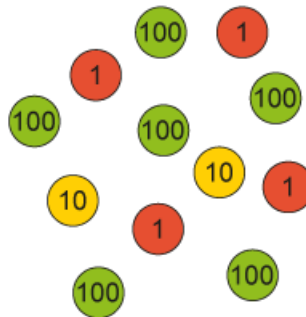

Figure 67: partitioning 654 into 620 and 34

You can find out more about fluency and recording for these calculations here in the calculation and fluency section: [Number, place value and number facts: 3NPV-2 and 3NF-3](#)

3NPV-2 Example assessment questions

1. What number is represented by these counters?



2. What number is represented by this expression?

$$1 + 10 + 10 + 100 + 100 + 10 + 10$$

3. Fill in the missing numbers to complete these partitioning diagrams.

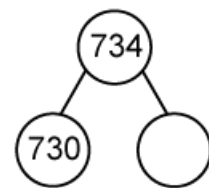
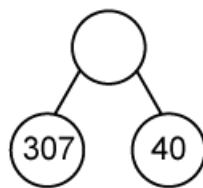
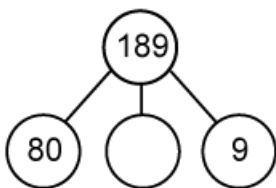
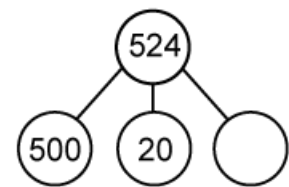
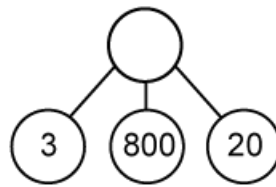
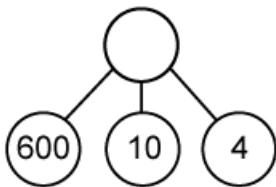

4. Fill in the missing numbers.

$$600 + 70 + 1 = \square$$

$$3 + 500 + 40 = \square$$

$$461 = \square + 60 + 1$$

$$20 + \square + 3 = 823$$

$$953 - 50 - 3 = \square$$

$$846 - \square - 40 = 800$$

$$\square = 203 + 90$$

$$\square = 290 + 3$$

$$628 = 20 + \square$$

$$628 = 8 + \square$$

5. Fill in the missing symbols (<, > or =).

$$100 + 60 + 5 \bigcirc 105 + 60$$

$$300 + 40 + 2 \bigcirc 300 + 24$$

$$783 - 80 \bigcirc 783 - 3$$

$$839 - 9 - 30 \bigcirc 839 - 39$$

6. There are 365 days in a year. If it rains on 65 days of the year, on how many days does it not rain?
7. A bamboo plant was 4m tall. Then it grew by another 83cm. How tall is the bamboo plant now? Express your answer in centimetres.
8. In the school library there are 25 books on the trolley and 250 books on the shelves. How many books are there altogether?
9. Francesco had 165 marbles. Then he gave 45 marbles to his friend. How many marbles does Francesco have now?
10. The tree outside Cecily's house is 308cm tall. How much further would it have to grow to reach the bottom of Cecily's bedroom window, at 3m 68cm?

3NPV–3 Three-digit numbers in the linear number system

Reason about the location of any *three*-digit number in the linear number system, including identifying the previous and next multiple of 100 and 10.

3NPV–3 Teaching guidance

Pupils need to be able to identify or place three-digit numbers on marked number lines with a variety of scales. Pupils should also be able to estimate the value or position of three-digit numbers on unmarked numbers lines, using appropriate proportional reasoning. Pupils should apply this skill to taking approximate readings of scales in measures and statistics contexts, as shown in the [3NPV–3](#) below. For more detail on identifying, placing and estimating positions of numbers on number lines, see year 2, [2NPV–2](#).

Pupils must also be able to identify which pair of multiples of 100 or 10 a given three-digit number is between. To begin with, pupils can use a number line for support. In this example, for the number 681, pupils must identify the previous and next multiples of 100 and 10.

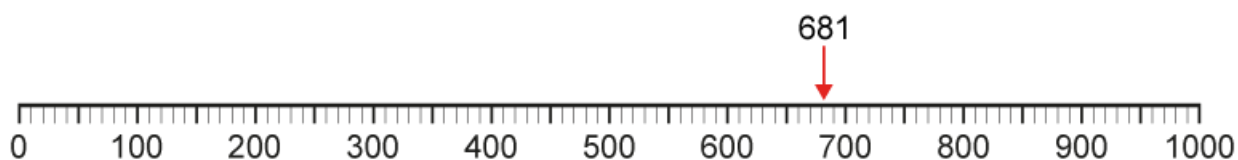

Figure 68: using a number line to identify the next and previous multiple of 100

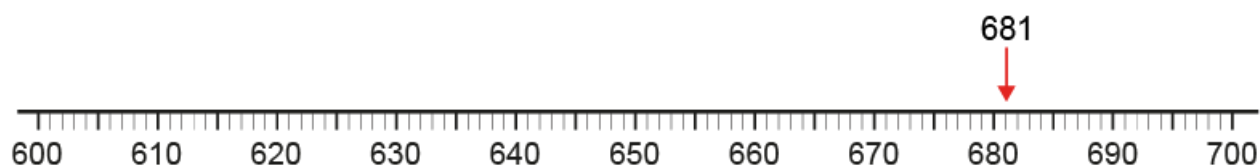

Figure 69: using a number line to identify the next and previous multiple of 10

Language focus

“The previous multiple of 100 is 600. The next multiple of 100 is 700.”

“The previous multiple of 10 is 680. The next multiple of 10 is 690.”

Pupils need to be able to identify previous and next multiples of 100 or 10 without the support of a number line.

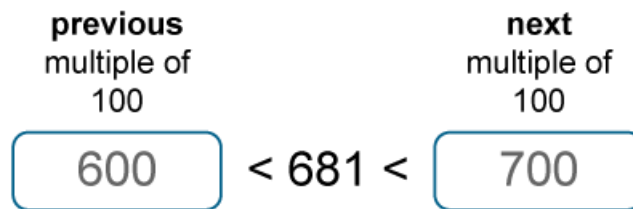

Figure 70: identifying the nearest multiple of 100

Finally, pupils should also be able to count forwards and backwards from any three-digit number in steps of 1 or 10. Pay particular attention to counting over 'boundaries', for example:

- 210, 200, 190
- 385, 395, 405

Making connections

Here, pupils must apply their knowledge that 10 tens is equal to 1 hundred (see [3NPV-1](#)) to understand that each interval of 100 on a number line or scale is made up of 10 intervals of 10. This also links to [3NPV-4](#), in which pupils need to be able to read scales divided into 2, 4, 5 and 10 equal parts.

3NPV-3 Example assessment questions

1. Fill in the missing numbers.

900		700	600		400		200
370		390			420		440

2. Estimate to fill in the missing numbers.

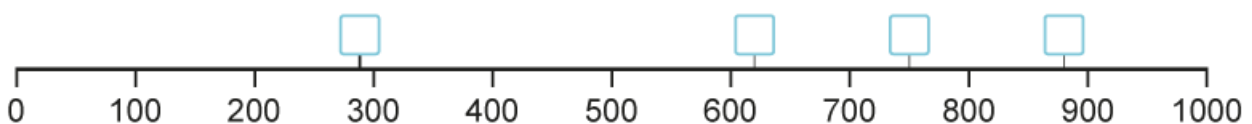

3. Estimate and mark the position of these numbers on the number line.

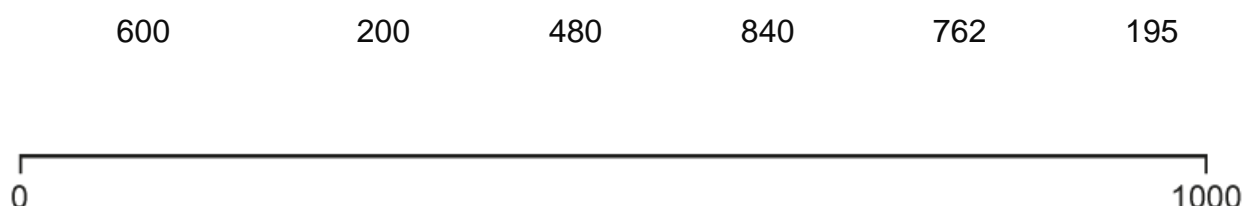

4. Fill in the missing numbers.

$$\begin{array}{ccccc} & 100 & & 100 & \\ & \text{less} & & \text{more} & \\ \square & \leftarrow & 800 & \rightarrow & \square \end{array}$$

$$\begin{array}{ccccc} & 10 & & 10 & \\ & \text{less} & & \text{more} & \\ \square & \leftarrow & 390 & \rightarrow & \square \end{array}$$

$$\begin{array}{ccccc} & 100 & & 100 & \\ & \text{less} & & \text{more} & \\ \square & \leftarrow & 100 & \rightarrow & \square \end{array}$$

$$\begin{array}{ccccc} & 10 & & 10 & \\ & \text{less} & & \text{more} & \\ \square & \leftarrow & 800 & \rightarrow & \square \end{array}$$

$$\begin{array}{ccccc} & \text{previous} & & \text{next} & \\ & \text{multiple} & & \text{multiple} & \\ & \text{of } 100 & & \text{of } 100 & \\ \square & \leftarrow & 630 & \rightarrow & \square \end{array}$$

$$\begin{array}{ccccc} & \text{previous} & & \text{next} & \\ & \text{multiple} & & \text{multiple} & \\ & \text{of } 100 & & \text{of } 100 & \\ \square & \leftarrow & 347 & \rightarrow & \square \end{array}$$

$$\begin{array}{ccccc} & \text{previous} & & \text{next} & \\ & \text{multiple} & & \text{multiple} & \\ & \text{of } 10 & & \text{of } 10 & \\ \square & \leftarrow & 492 & \rightarrow & \square \end{array}$$

$$\begin{array}{ccccc} & \text{previous} & & \text{next} & \\ & \text{multiple} & & \text{multiple} & \\ & \text{of } 10 & & \text{of } 10 & \\ \square & \leftarrow & 347 & \rightarrow & \square \end{array}$$

5. Look at lines A, B and C. Can you estimate how long they are by comparing them to the 1,000cm lines?

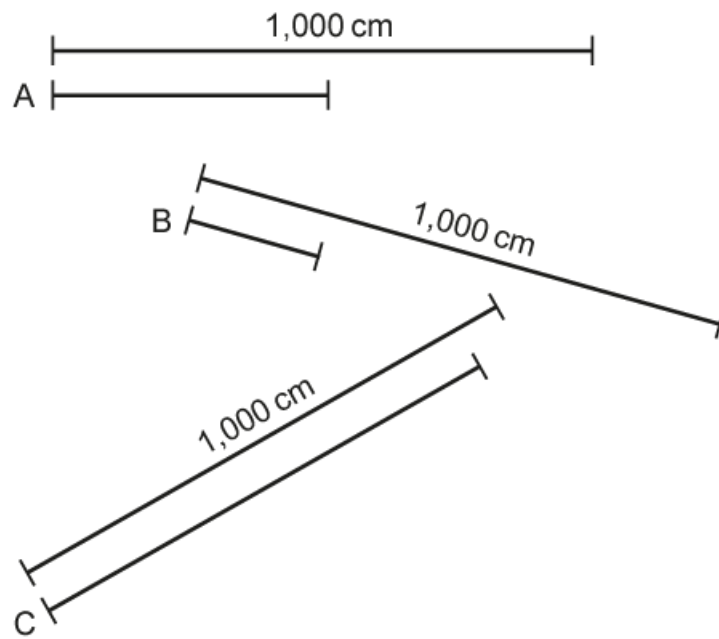

6. Estimate the mass, in grams, shown on this weighing scale.

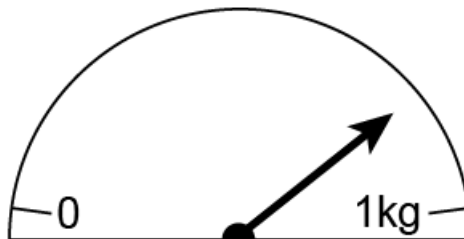

3NPV–4 Reading scales with 2, 4, 5 or 10 intervals

Divide 100 into 2, 4, 5 and 10 equal parts, and read scales/number lines marked in multiples of 100 with 2, 4, 5 and 10 equal parts.

3NPV–4 Teaching guidance

By the end of year 3, pupils must be able to divide 100 into 2, 4, 5 or 10 equal parts. This is important because these are the intervals commonly found on measuring instruments and graph scales.

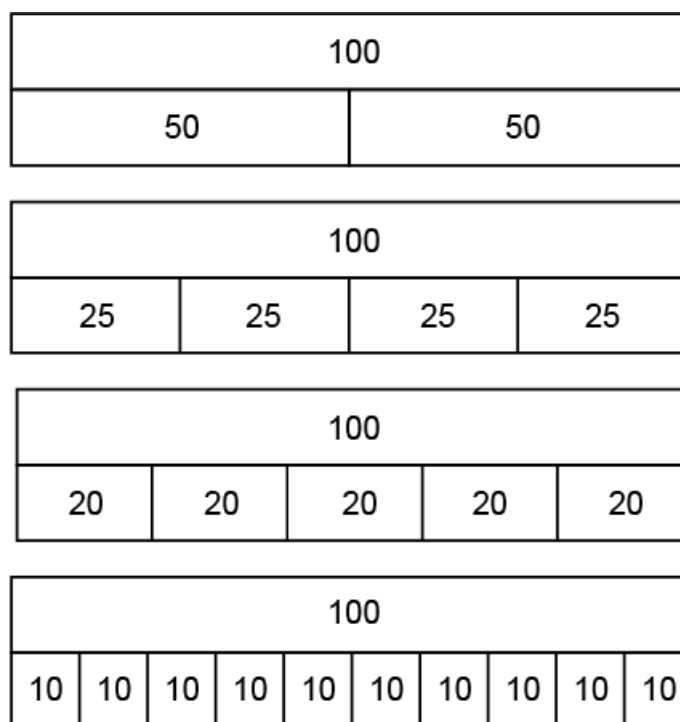

Figure 71: Bar models showing 100 partitioned into 2, 4, 5 and 10 equal parts

Pupils should practise counting in multiples of 10, 20, 25, and 50 from 0, or from any multiple of these numbers, both forwards and backwards. This is an important step in becoming fluent with these number patterns. Pupils will have been practising counting in multiples of 1, 2 and 5 since year 1, and this supports counting in units of 10, 20 and 50. However, counting in units of 25 is not based on any multiples with which pupils are already familiar, so they typically find this the most challenging.

Language focus

“Twenty-five, fifty, seventy-five, one hundred” needs to be a fluent spoken language pattern, which pupils can continue over 100.

Pupils should be able to apply this skip counting beyond 100, to solve contextual multiplication and division measures problems, as shown in the [3NPV-4](#) below (questions 5 and 7). Pupils should also be able to write and solve multiplication and division equations related to multiples of 10, 20, 25 and 50 up to 100.

Pupils need to be able to solve addition and subtraction problems based on partitioning 100 into multiples of 10, 20 and 50 based on known number bonds to 10. Pupils should also have automatic recall of the fact that 25 and 75 are bonds to 100. They should be able to automatically answer a question such as “I have 1m of ribbon and cut off 25cm. How much is left in centimetres?”

Making connections

Dividing 100 into 10 equal parts is also assessed as part of [3NPV-1](#).

Reading scales builds on number line knowledge from [3NPV-3](#). Conversely, experience of working with scales with 2, 4, 5 or 10 divisions in this criterion improves pupils’ estimating skills when working with unmarked number lines and scales as described in [3NPV-3](#).

3NPV-4 Example assessment questions

1. Fill in the missing numbers.

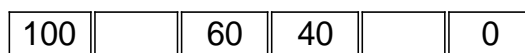
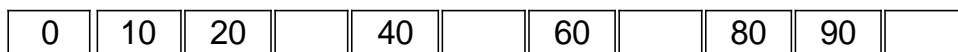
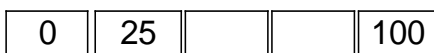
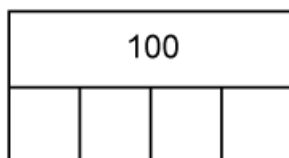

2. What were Jenny and Asif's scores?

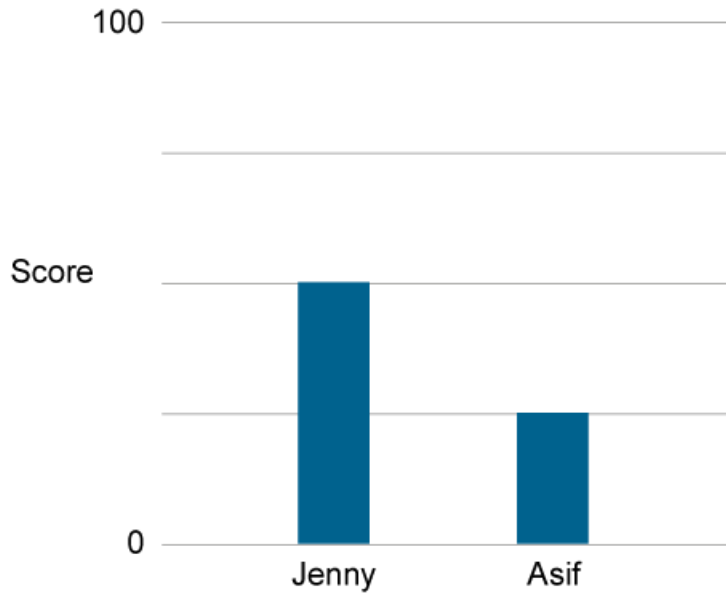

3. Miss Scot weighs herself. How much does she weigh, in kilograms?

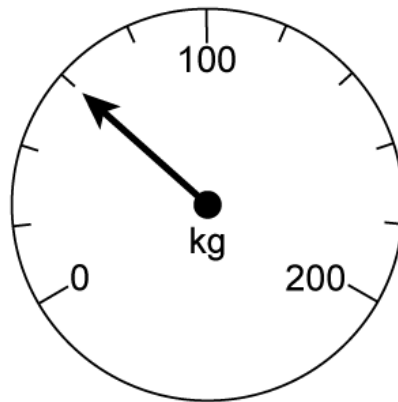

4. How many centimetres long is the ribbon?



5. How many 25p cupcakes can I buy for £5?

6. How many 50cm lengths of wood can I cut from a 3m plank?

7. We raise £100 at the school fair and divide the money equally between 5 charities. How much does each charity get?

8. Fill in the missing numbers.

$100 \div 4 = \square$

$\square \times 20 = 100$

$100 \div 50 = \square$

$25 + \square = 100$

9. Stan counts from 0 in multiples of 25. Circle the numbers he will say.

100 25 240 155 400 275 505 350

3NF–1 Fluently add and subtract within and across 10

Secure fluency in addition and subtraction facts that bridge 10, through continued practice.

3NF–1 Teaching guidance

Before pupils begin work on columnar addition and subtraction ([3AS–1](#)), it is essential that pupils have automatic recall of addition and subtraction facts within and across 10. These facts are required for calculation within the columns in columnar addition and subtraction. All mental calculation also depend on these facts.

Identifying core number facts: columnar addition	Identifying core number facts: columnar subtraction
$\begin{array}{r} 465 \\ + 429 \\ \hline 894 \\ \hline 1 \end{array}$ <p>Figure 72: columnar addition of 465 and 429</p>	$\begin{array}{r} \overset{6}{7}49 \\ - 286 \\ \hline 463 \end{array}$ <p>Figure 73: columnar subtraction of 286 from 749</p>
<p>Within-column calculations:</p> $5 + 9 = 14$ $6 + 2 + 1 = 9$ $4 + 4 = 8$	<p>Within-column calculations:</p> $9 - 6 = 3$ $7 - 1 = 6$ $14 - 8 = 6$ $6 - 2 = 4$

Pupils should already have automatic recall of addition and subtraction facts within 10, from year 1 ([1NF–1](#)). In year 2 ([2AS–1](#)), pupils learnt strategies for addition and subtraction across 10. However, year 3 pupils are likely to need further practice, and reminders of the strategies, to develop sufficient fluency. Pupils should practise until they achieve automaticity in the mental application of these strategies. Without this practice many pupils are likely to still be reliant on counting on their fingers to solve within-column calculations in columnar addition and subtraction.

The full set of addition calculations that pupils need for columnar addition are shown on the next page. The number of facts to be learnt is reduced when commutativity is applied and pupils recognise that $7 + 5$, for example, is the same as $5 + 7$. Automaticity in subtraction facts should also be developed through the application of the relationship between addition and subtraction, for example, pupils should recognise that if $7 + 5 = 12$ then $12 - 5 = 7$.

+	0	1	2	3	4	5	6	7	8	9	10
0	0+0	0+1	0+2	0+3	0+4	0+5	0+6	0+7	0+8	0+9	0+10
1	1+0	1+1	1+2	1+3	1+4	1+5	1+6	1+7	1+8	1+9	1+10
2	2+0	2+1	2+2	2+3	2+4	2+5	2+6	2+7	2+8	2+9	2+10
3	3+0	3+1	3+2	3+3	3+4	3+5	3+6	3+7	3+8	3+9	3+10
4	4+0	4+1	4+2	4+3	4+4	4+5	4+6	4+7	4+8	4+9	4+10
5	5+0	5+1	5+2	5+3	5+4	5+5	5+6	5+7	5+8	5+9	5+10
6	6+0	6+1	6+2	6+3	6+4	6+5	6+6	6+7	6+8	6+9	6+10
7	7+0	7+1	7+2	7+3	7+4	7+5	7+6	7+7	7+8	7+9	7+10
8	8+0	8+1	8+2	8+3	8+4	8+5	8+6	8+7	8+8	8+9	8+10
9	9+0	9+1	9+2	9+3	9+4	9+5	9+6	9+7	9+8	9+9	9+10
10	10+0	10+1	10+2	10+3	10+4	10+5	10+6	10+7	10+8	10+9	10+10

Pupils need extensive practice to meet this criterion. You can find out more about fluency for addition and subtraction within and across 10 here in the calculation and fluency section: [3NF-1](#)

Making connections

Fluency in these addition and subtraction facts is required for within-column calculation in columnar addition and subtraction (

[3AS-2](#)).

3NF-1 Example assessment questions

1. Mr Kahn drove 8km to get to his friend's house, and then drove another 3km with his friend to get to the gym. How far did Mr Kahn drive?
2. There are 12 children. 5 of them can ride a bicycle and the rest cannot. How many of the children cannot ride a bicycle?
3. Maja had £17. Then she spent £9. How much money does she have left?

4. I have 6 metres of red ribbon and 6 metres of blue ribbon. How many metres of ribbon do I have altogether?
5. Hazeem is growing a sunflower and a bean plant. So far, his sunflower plant is 14cm tall and his bean plant is 8cm tall. How much taller is the sunflower plant than the bean plant?

Assessment guidance: For pupils to have met criterion **3NF–1**, they need to be able to add and subtract within and across 10 without counting forwards or backwards in ones on their fingers, on a number line or in their heads. Pupils need to be able to automatically recall the facts within 10, and be able to mentally apply strategies for calculation across 10, with accuracy and speed. Teachers should assess pupils in small groups – simply providing the correct answers to the example questions above does not demonstrate that a pupil has met the criterion. The full set of addition and subtraction facts which children need to be fluent in is shown in the appendix.

3NF–2 Recall of multiplication tables

Recall multiplication facts, and corresponding division facts, in the 10, 5, 2, 4 and 8 multiplication tables, and recognise products in these multiplication tables as multiples of the corresponding number.

3NF–2 Teaching guidance

The national curriculum requires pupils to recall multiplication table facts up to 12×12 , and this is assessed in the year 4 multiplication tables check. In year 3, the focus should be on learning facts in the 10, 5, 2, 4 and 8 multiplication tables.

Language focus

When pupils commit multiplication table facts to memory, they do so using a verbal sound pattern to associate the 3 relevant numbers, for example, “six fours are twenty-four”. It is important to provide opportunities for pupils to verbalise each multiplication fact as part of the process of developing fluency.

While pupils are learning the individual multiplication tables, they should also learn that:

- the factors can be written in either order and the product remains the same (for example, we can write $3 \times 4 = 12$ or $4 \times 3 = 12$ to represent the third fact in the 4 multiplication table)
- the products within each multiplication table are multiples of the corresponding number, and be able to recognise multiples (for example, pupils should recognise that 64 is a multiple of 8, but that 68 is not)
- adjacent multiples in, for example, the 8 multiplication table, have a difference of 8

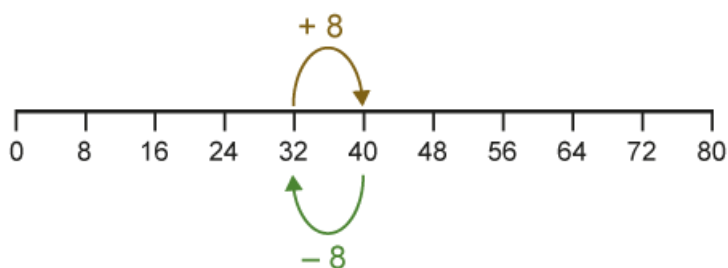

×	1	2	3	4	5	6	7	8
1	●	●	●	●	●	●	●	●
2	●	●	●	●	●	●	●	●
3	●	●	●	●	●	●	●	●
4	●	●	●	●	●	●	●	●
5	●	●	●	●	●	●	●	●

Figure 74: number line and array showing that adjacent multiples of 8 (32 and 40) have a difference of 8

As pupils develop automatic recall of multiplication facts, they should learn how to use these to derive division facts. They must be able to use these ‘known division facts’ to solve division calculations, instead of using the skip counting method they learnt in year 2 ([2MD-2](#)). Pupils should learn to make the connection between multiplication and division facts as they learn each multiplication table, rather than afterwards.

Language focus

“4 times 5 is 20, so 20 divided by 5 is 4.”

It is useful for pupils to learn the 10 and 5 multiplication tables one after the other, and then the 2, 4 and 8 multiplication tables one after the other. The connections and patterns will help pupils to develop fluency and understanding.

You can find out more about developing automatic recall of multiplication tables here in the calculation and fluency section: [3NF-2](#)

Making connections

Alongside developing fluency in multiplication tables facts and corresponding division facts, pupils must learn to apply them to solve contextual problems with different multiplication and division structures ([3MD-1](#)).

In [3F-2](#) pupils use known division facts to find unit fractions of quantities, for example $36 \div 4 = 9$, so $\frac{1}{4}$ of $36 = 9$.

3NF-2 Example assessment questions

1. A spider has 8 legs. If there are 5 spiders, how many legs are there altogether?
2. A book costs £5. How much do 6 books cost?
3. 18 socks are put into pairs. How many pairs are there?
4. Felicity wants to buy a scooter for £60. If she pays with £10 notes, how many notes does she need?
5. Circle the numbers that are multiples of 4.

14 24 40 34 16 32 25

Assessment guidance: The multiplication tables check in year 4 will assess pupils' fluency in all multiplication tables. At this stage, teachers should assess fluency in facts within the 10, 5, 2, 4 and 8 multiplication tables. Once pupils can automatically recall multiplication facts, and have covered criterion [3MD-1](#), they should be able to apply their knowledge to contextual questions like those shown here. Teachers should ensure that pupils answer these questions using automatic recall of the appropriate multiplication facts – for question 1, for example, if a pupil counts up in multiples of 8, or draws 5 spiders and counts the legs in ones, the pupil has not met this criterion.

3NF-3 Scaling number facts by 10

Apply place-value knowledge to known additive and multiplicative number facts (scaling facts by 10), for example:

$$8 + 6 = 14 \text{ and } 14 - 6 = 8$$

so

$$80 + 60 = 140 \text{ and } 140 - 60 = 80$$

$$3 \times 4 = 12 \text{ and } 12 \div 4 = 3$$

so

$$30 \times 4 = 120 \text{ and } 120 \div 4 = 30$$

3NF-3 Teaching guidance

During year 3, pupils develop automaticity in addition and subtraction facts within 20 ([3NF-1](#)), and learn to recall multiplication table facts and related division facts for the 10, 5, 2, 4 and 8 multiplication tables. To be ready to progress to year 4, pupils must also be able to combine these facts with unitising in tens, including:

- scaling known additive facts within 10, for example, $90 - 60 = 30$
- scaling known additive facts that bridge 10, for example, $80 + 60 = 140$
- scaling known multiplication tables facts, for example, $30 \times 4 = 120$
- scaling division facts derived from multiplication tables, for example, $120 \div 4 = 30$

For calculations such as $80 + 60 = 140$, pupils can begin by using tens frames and counters as they did for calculation across 10 ([2AS-1](#)), but now using 10-value counters.

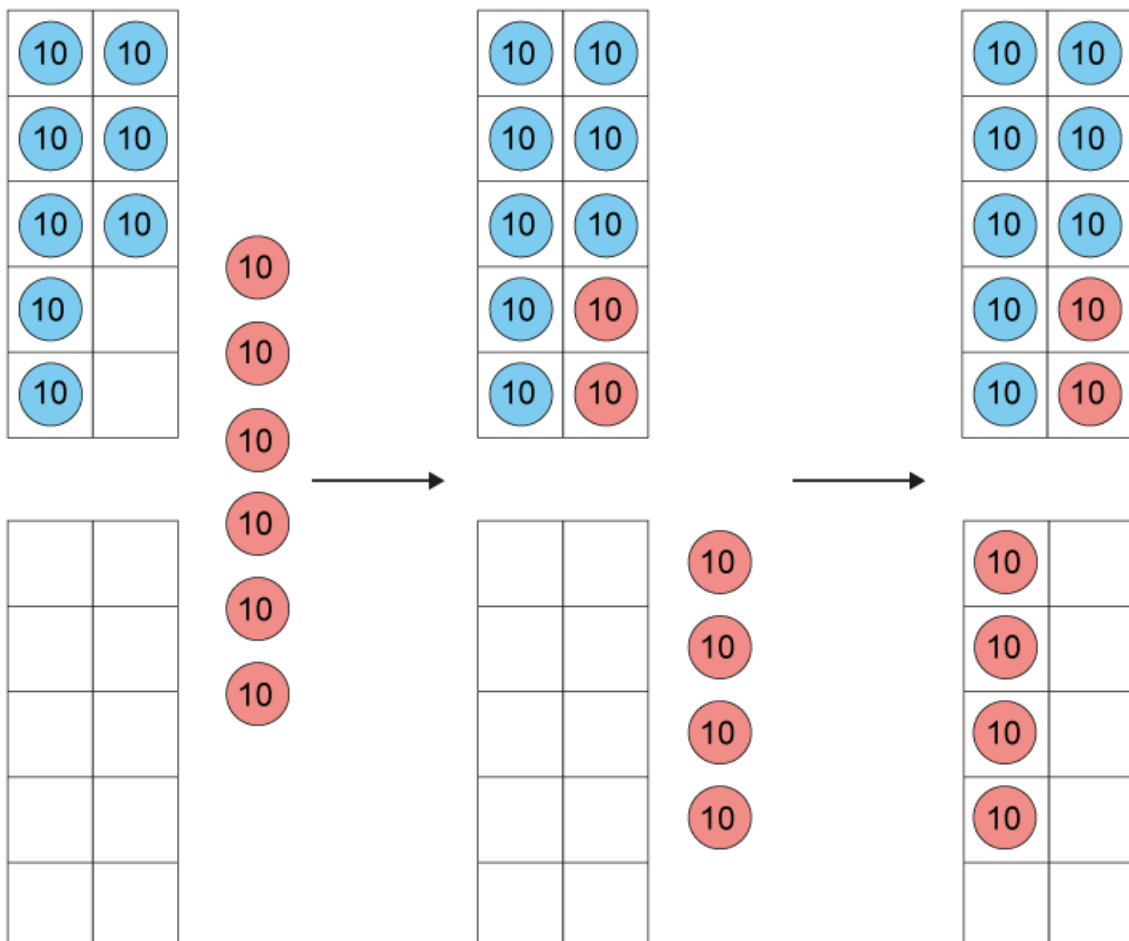

Figure 75: tens frames with 10-value counters showing $80 + 60 = 140$

$$8 + 6 = 14$$
$$80 + 60 = 140$$

$$14 - 6 = 8$$
$$140 - 60 = 80$$

$$14 - 8 = 6$$
$$140 - 80 = 60$$

You can find out more about fluency and recording for these calculations here in the calculation and fluency section: [Number, place value and number facts: 3NPV-2 and 3NF-3](#)

Similarly, pupils can use 10-value counters to understand how a known multiplicative fact, such as $3 \times 5 = 15$, relates to a scaled calculation, such as $3 \times 50 = 150$. Pupils should be able to reason in terms of unitising in tens.

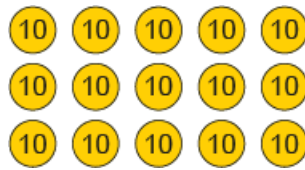

Figure 76: 3-by-5 array of 10-value place-value counters

$$3 \times 5 = 15$$
$$3 \times 50 = 150$$

$$3 \times 5 = 15$$
$$30 \times 5 = 150$$

Language focus

“3 times 5 is equal to 15.”

“3 times 5 tens is equal to 15 tens.”

“15 tens is equal to 150.”

Language focus

“3 times 5 is equal to 15.”

“3 tens times 5 is equal to 15 tens.”

“15 tens is equal to 150.”

Multiplication calculations in this criterion should all be related to the 5, 10, 2, 4 and 8 multiplication tables. It is important for pupils to understand all of the calculations in this criterion in terms of working with units of 10.

Making connections

This criterion builds on:

- additive fluency within and across 10 ([3NF-1](#))
- [3NF-2](#) , where pupils develop fluency in multiplication and division facts
- [3NPV-1](#), where pupils need to be able to work out how many tens there are in any three-digit multiple of 10

Meeting this criterion also requires pupils to be able to fluently multiply whole numbers by 10 ([3NF-2](#)).

3NF-3 Example assessment questions

1. A garden table costs £80 and 2 garden chairs each cost £60. How much do the 2 chairs and the table cost altogether?
2. 130 people are expected at a concert. So far 70 people have arrived. How many more people are due to arrive?
3. A family ticket for a safari park is £40. 3 families go together. How much do the 3 family tickets cost altogether?
4. Fill in the missing numbers.

$$30 + \square = 110$$

$$7 \times 60 = \square$$

3AS–1 Calculate complements to 100

Calculate complements to 100, for example:

$$46 + ? = 100$$

3AS–1 Teaching guidance

Calculating complements to 100 is an important skill, because it is a prerequisite for calculating how much change is due when paying for an item. When pupils calculate complements (the amount needed to complete a total), a common error is to end up with a total that is too large:

- When calculating complements to 100, pupils typically make an extra ‘unit’ of 10, making 110 instead of 100.
- When finding change from a whole number of pounds, pupils typically make an extra £1, for example, they incorrectly calculate the change due from £5 for a cost of £3.40 as £2.60

It is important for pupils to spend time specifically learning about calculating complements, including the risk of creating ‘extra units’. This should begin in year 3, with calculating complements to 100.

Pupils should compare correct calculations with the corresponding common incorrect calculations for complements to 100. They should be able to discuss the pairs of calculations and understand the source of the error in the incorrect calculations.

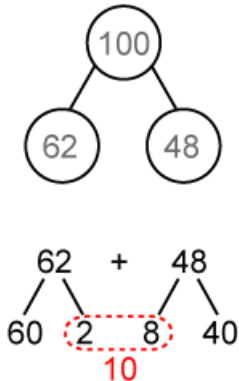
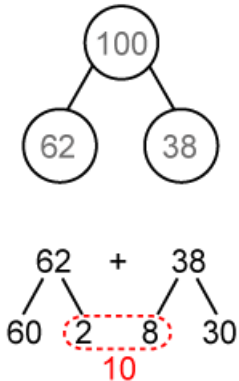
Incorrect complement to 100	Correct complement to 100
 <p data-bbox="180 1686 759 1787">Figure 77: partitioning diagram and calculation showing incorrect complement to 100: 62 and 48</p>	 <p data-bbox="828 1686 1382 1787">Figure 78: partitioning diagram and calculation showing correct complement to 100: 62 and 38</p>

A shaded 100 grid can be used to show why there are only 9 full tens in the correct complements to 100. The 10th ten is composed of the ones digits.

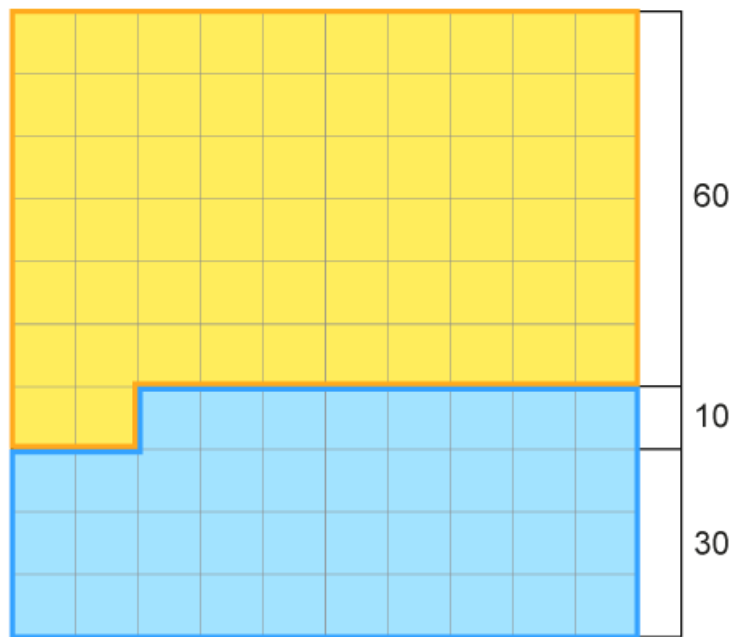

Figure 79: a 100 grid shaded in 2 colours to represent 62 and 38 as a complement to 100

Once pupils understand why given complements to 100 are correct or not, they should learn to work in steps to calculate complements themselves:

1. First make 10 ones.
2. Then work out the number of additional tens needed. Pupils must understand that the tens digits should bond to 9, not to 10.
3. Check that the 2 numbers sum to 100.

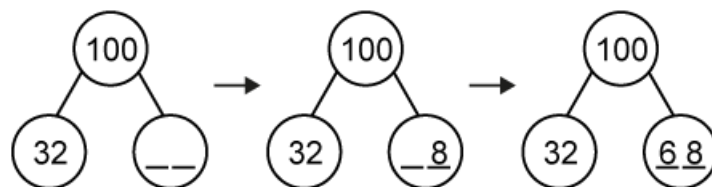

Figure 80: calculating a complement to 100

Language focus

“First we make 10 ones. The ones digits add up to 1 ten, so we need 9 more tens.”

Making connections

Pupils will need to calculate the majority of two-digit complements to 100 as described above. However, pupils should memorise the pair 75 and 25 (see [3NPV-4](#)).

3AS–1 Example assessment questions

1. Which of these are correct complements to 100 and which have an extra 10? Tick the correct column. Explain your answers.

	Correct bond to 100	Incorrect bond to 100 (extra 10)	Explanation
$28 + 72$			
$61 + 49$			
$55 + 45$			
$43 + 67$			
$84 + 16$			
$39 + 71$			

2. Fill in the missing numbers.

$$65 + \square = 100$$

$$100 - 29 = \square$$

$$100 = 42 + \square$$

$$\square = 100 - 83$$

3. A dressmaker had 1m of ribbon. Then she used 22cm of it. How many centimetres of ribbon does she have left?
4. A toy shop sells ping-pong balls for 65p each. If I use a £1 coin to pay for a ping-pong ball, how much change will I get, in pence?
5. Mr Jones has 100 stickers. 47 of them are gold and the rest are silver. How many are silver?

3AS–2 Columnar addition and subtraction

Add and subtract up to three-digit numbers using columnar methods.

3AS–2 Teaching guidance

Pupils must learn to add and subtract using the formal written methods of columnar addition and columnar subtraction. Pupils should master columnar addition, including calculations involving regrouping (some columns sum to 10 or more), before learning columnar subtraction. However, guidance here is combined due to the similarities between the two algorithms.

Beginning with calculations that do not involve regrouping (no columns sum to 10 or more) or exchange (no columns have a minuend smaller than the subtrahend), pupils should:

- learn to lay out columnar calculations with like digits correctly aligned
- learn to work from right to left, adding or subtracting the least significant digits first

Teachers should initially use place-value equipment, such as Dienes, to model the algorithms and help pupils make connections to what they already know about addition and subtraction.

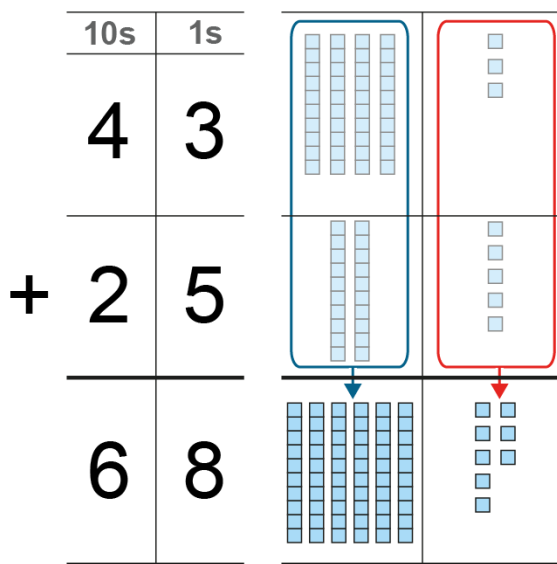

Figure 81: columnar addition with no regrouping: calculation and Dienes representation

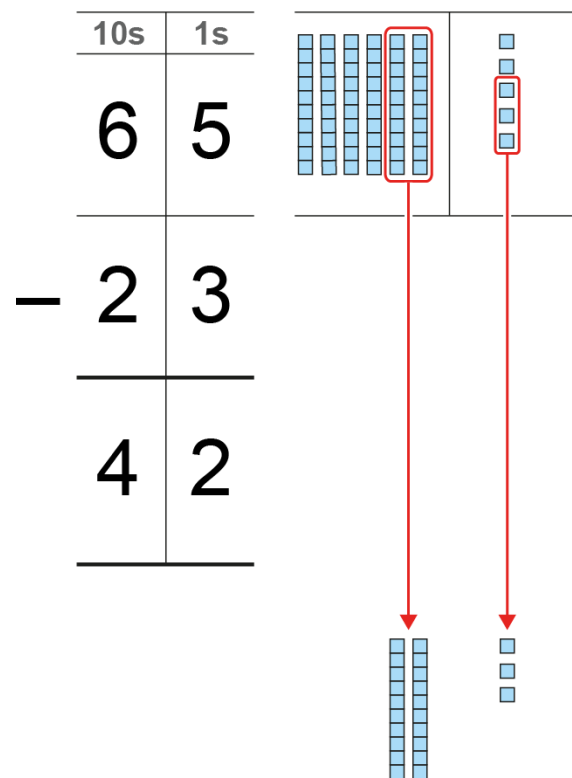

Figure 82: columnar subtraction with no exchange: calculation and Dienes representation

Pupils should use unitising language to describe within-column calculations.

Language focus

“3 ones plus 5 ones is equal to 8 ones.”

“4 tens plus 2 tens is equal to 6 tens.”

“5 ones minus 3 ones is equal to 2 ones.”

“6 tens minus 2 tens is equal to 4 tens.”

Pupils must also learn to carry out columnar addition calculations that involve regrouping, and columnar subtraction calculations that involve exchange. Regrouping and exchange build on pupils’ understanding that 10 ones is equivalent to 1 ten, and that 10 tens is equivalent to 1 hundred. Dienes can be used to model the calculations, and to draw attention to the regrouping/exchange.

Dienes (or any other place-value apparatus) should be used, only initially, to support pupils understanding of the structure of the algorithms, and should not be used as a tool for finding the answer. Once pupils understand the algorithms, they should use known facts to perform the calculation in each column ([3NF-1](#)). For calculations with more than 2 addends, pupils should add the digits within a column in the most efficient order.

Figure 83: making efficient choices for within-column calculations when adding 3 addends

Pupils must learn that, although columnar methods can be used for any additive calculation, they are not always the most appropriate choice. For example, $164 + 36$ can be calculated by recognising that 64 and 36 is a complement to 100, while $120 + 130$ maybe be calculated by unitising in tens (12 tens + 13 tens = 25 tens) or by recognising that $20 + 30 = 50$.

Throughout, pupils should continue to recognise the inverse relationship between addition and subtraction. Pupils may represent calculations using partitioning diagrams or bar models, and should learn to check their answers using the inverse operation.

Figure 84: using addition to check a subtraction calculation

You can find out more about fluency for these calculations here in the calculation and fluency section: [3AS-2](#)

Making connections

The within-column calculations in columnar addition and subtraction use the facts practised to fluency in [3NF-1](#). Any additive calculation can be carried out using columnar methods. However other methods may sometimes be more efficient, such as those taught in [3NPV-3](#) and [3NF-3](#).

3AS–2 Example assessment questions

1. Solve these calculations using columnar addition or columnar subtraction.

a. $89 - 23$

c. $402 + 130 + 78$

e. $345 - 72$

b. $127 + 43 + 49$

d. $462 - 256$

f. $407 - 129$

2. Year 3 want to buy some sports equipment which costs £472. So far they have raised £158. How much more money do they need to raise?

3. Cheryl has £135. She spends £53 on some new trainers. How much money does she have left?

4. There are 172 non-fiction books in the school library and 356 fiction books. How many books are there in the library altogether?

5. Fill in the missing numbers.

$$\begin{array}{r} 262 \\ + 3\boxed{1} \\ \hline 583 \end{array}$$

$$\begin{array}{r} 322 \\ + 16\boxed{1} \\ \hline 491 \end{array}$$

$$\begin{array}{r} 627 \\ - 11\boxed{1} \\ \hline 514 \end{array}$$

$$\begin{array}{r} 7\boxed{1}4 \\ - 62 \\ \hline \boxed{1}32 \end{array}$$

6. Mahsa carries out the following columnar addition calculation.

$$\begin{array}{r} 628 \\ + 159 \\ \hline 787 \\ \hline 1 \end{array}$$

Write a columnar subtraction calculation that she could do to check that her calculation is correct.

7. Complete the following calculations. Choose carefully which method to use.

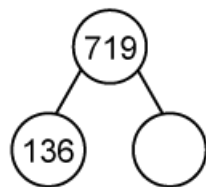
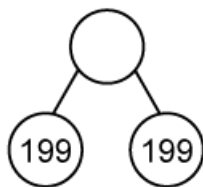

$175 + 25$

$776 - 200$

$63 + 89 + 42$

$523 - 247$

$50 + 250 + 300$

$400 - 35$

3AS–3 Manipulate the additive relationship

Manipulate the additive relationship:

- Understand the inverse relationship between addition and subtraction, and how both relate to the part–part–whole structure.
- Understand and use the commutative property of addition, and understand the related property for subtraction.

3AS–3 Teaching guidance

Pupils will begin year 3 with an understanding of some of the individual concepts covered in this criterion, and will already be familiar with using partitioning diagrams and bar models. However, pupils need to leave year 3 with a coherent understanding of the additive relationship, and how addition and subtraction equations relate to the various additive structures.

Pupils must understand that the simplest addition and subtraction equations describe the relationship between 3 numbers, where one is a sum of the other two. They should understand that both addition and subtraction equations can be used to describe the same additive relationship. They should practise writing the full set of 8 equations that are represented by a given partitioning diagram or bar model.

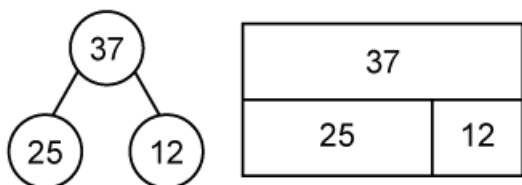

Figure 85: partitioning diagrams showing the additive relationship between 25, 12 and 37

$$25 + 12 = 37$$

$$12 + 25 = 37$$

$$37 = 25 + 12$$

$$37 = 12 + 25$$

$$37 - 12 = 25$$

$$37 - 25 = 12$$

$$25 = 37 - 12$$

$$12 = 37 - 25$$

Pupils should learn and use the correct names for the terms in addition and subtraction equations.

addend + addend = sum

minuend – subtrahend = difference

Pupils understanding should go beyond the fact that addition and subtraction are inverse operations. They need understand how the terms in addition and subtraction equations are related to each other, and to the parts and whole within an additive relationship, and use this understanding to manipulate equations.

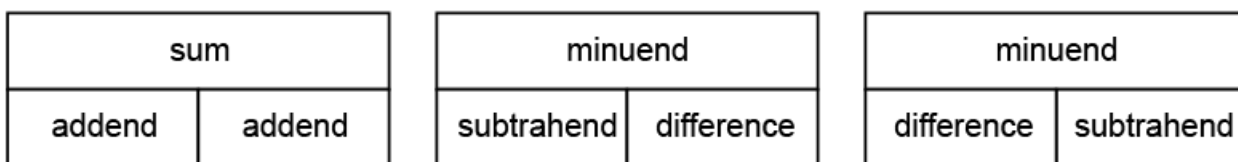

Figure 86: connecting the terms in addition and subtraction equations to the part-part-whole structure

With experience of the commutative property of addition, pupils can now learn that, because of the relationship between addition and subtraction, the commutative property has a related property for subtraction.

Language focus

“If we swap the values of the subtrahend and difference, the minuend remains the same.”

Both of the following equations are therefore correct:

$$37 - 25 = 12$$

$$37 - 12 = 25$$

Pupils should use their understanding of the additive relationship and how it is related to parts and a whole, the inverse relationship between addition and subtraction, and the commutative property, to manipulate equations. They must recognise that if 2 of the 3 numbers in a given additive relationship are known, the unknown number can always be determined: addition is used to find an unknown whole, while subtraction is used to find an unknown part, irrespective of how the problem is presented. For example, $34 + ? = 56$ has an unknown part so is solved using subtraction, even though the problem is written as addition. Pupils need to be able to solve:

- missing-addend problems ($\text{addend} + ? = \text{sum}$)
- missing-subtrahend problems ($\text{minuend} - ? = \text{difference}$)
- missing-minuend problems ($? - \text{subtrahend} = \text{difference}$)

Pupils have been solving missing-number problems since year 1. However, with smaller numbers, they were able to rely on missing-number facts (known number bonds) or counting on (for example, counting on 3 fingers to get from 12 to 15 for $12 + ? = 15$). Now that pupils are using numbers with up to three digits, they will need to rearrange missing-number equations to solve them, using formal written methods where necessary.

Teachers should not assume that pupils will be able to do this automatically: pupils will need to spend time learning the properties of the additive relationship, and practising rearranging equations. They should be able to identify the type of each problem in terms

of whether a part or the whole is unknown, and can sketch partitioning diagrams or bar models to help them do this.

<p>Missing-addend problems</p>	<p>Type of problem: missing part</p> <p>Rewrite the addition equation as a subtraction equation, for example:</p> $329 + \square = 743 \rightarrow 743 - 329 = \square$ <p>Language focus</p> <p>“There is a missing part. To find the missing part, we subtract the other part from the whole.”</p>
<p>Missing-subtrahend problems</p>	<p>Type of problem: missing part</p> <p>Rewrite the subtraction equation by swapping the subtrahend and the difference, for example:</p> $477 - \square = 285 \rightarrow 477 - 285 = \square$ <p>Language focus</p> <p>“There is a missing part. To find the missing part, we subtract the other part from the whole.”</p>
<p>Missing-minuend problems</p>	<p>Type of problem: missing whole</p> <p>Rewrite the subtraction equation as an addition equation, for example:</p> $\square - 527 = 87 \rightarrow 527 + 87 = \square$ <p>Language focus</p> <p>“There is a missing whole. To find the missing whole, we add the 2 parts.”</p>

Making connections

Once pupils have identified the calculation required to solve a missing-number problem, they need to be able to perform that calculation. Pupils must be fluent in identifying and applying appropriate addition and subtraction strategies.

3AS–3 Example assessment questions

Fill in the missing numbers.

$$364 + \square = 857$$

$$\square - 785 = 180$$

$$145 = 721 - \square$$

$$250\text{cm} = 65\text{cm} + \square$$

3MD–1 Multiplication and division structures

Apply known multiplication and division facts to solve contextual problems with different structures, including quotitive and partitive division.

3MD–1 Teaching guidance

At this stage, pupils will be developing fluency in the 5, 10, 2, 4 and 8 multiplication tables (**3NF–2**), so should be able to solve multiplication problems about groups of 5, 10, 2, 4 or 8. Pupils have already begun to learn that if the factors are swapped, the product remains the same (**3NF–2**).

Language focus

“factor times factor is equal to product”

“The order of the factors does not affect the product.”

Pupils should also learn that the commutative property allows them to use their known facts to solve problems about 5, 10, 2, 4 or 8 equal groups (for example, 2 groups of 7). An array can be used to illustrate how the commutative property relates to different grouping interpretations – the example below shows that 7 groups of 2 and 2 groups of 7 both correspond to the same total quantity (14).

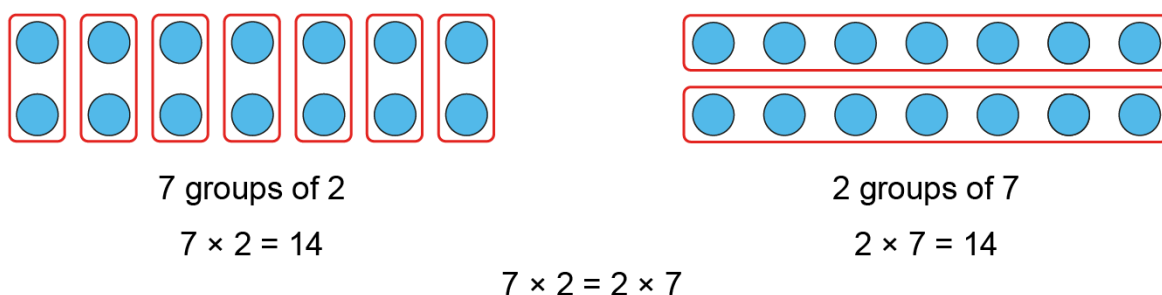
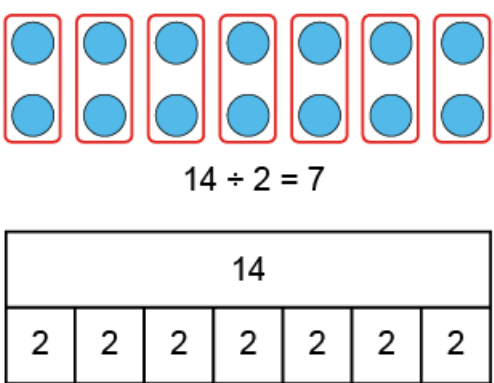
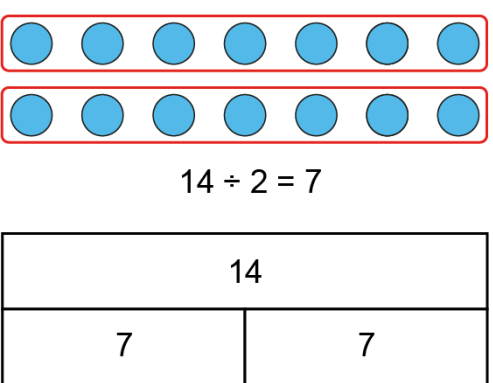

Figure 87: using an array to show that 7 groups of 2 and 2 groups of 7 both correspond to the same total quantity

This means that pupils can use their knowledge that $7 \times 2 = 14$ to solve a problem about 2 groups of 7, even though they have not yet learned the 7 multiplication table.

Pupils should already be solving division calculations using known division facts corresponding to the 5, 10, 2, 4 and 8 multiplication tables (**3NF–2**). They must also be able to use these known facts to solve both quotitive (grouping) and partitive (sharing) contextual division problems. The same array that was used to illustrate the commutative

property of multiplication can also be used to show how known division facts can be applied to the two different division structures.

Quotitive division	Partitive division
<p>I need 14 ping-pong balls. There are 2 ping-pong balls in a pack. How many packs do I need?</p>  <p style="text-align: center;">$14 \div 2 = 7$</p> <p style="text-align: center;">Figure 88: using an array and bar model to show that 14 divided into groups of 2 is equal to 7</p> <p>Language focus</p> <p>“7 times 2 is 14, so 14 divided by 2 is 7.”</p> <p>“14 divided into groups of 2 is equal to 7.”</p> <p>I need 7 packs of ping-pong balls.</p>	<p>£14 is shared between 2 children. How much money does each child get?</p>  <p style="text-align: center;">$14 \div 2 = 7$</p> <p style="text-align: center;">Figure 89: using an array and bar model to show that 14 shared between 2 is equal to 7</p> <p>Language focus</p> <p>“7 times 2 is 14, so 14 divided by 2 is 7.”</p> <p>“£14 shared between 2 is equal to £7 each.”</p> <p>Each child gets £7.</p>

At this stage, pupils only need to be able to apply division facts corresponding to division by 5, 10, 2, 4 and 8 to solve division problems with the two different contexts. In year 4, pupils will learn, for example, that if they know that $2 \times 7 = 14$, then they know both $14 \div 2 = 7$ and $14 \div 7 = 2$.

When pupils are solving contextual problems, dividing into groups of 5, 10, 2, 4 or 8 (quotitive division) or sharing into 5, 10, 2, 4 or 8 parts (partitive division), they should calculate by recalling a known multiplication fact rather than by skip counting, as described in **3NF-2** and illustrated above.

Making connections

Using the commutative law of multiplication reduces the number of multiplication tables facts that pupils need to memorise, both in year 3 ([3NF-2](#)) and beyond. Being able to calculate the size of a part in partitive contexts using known division facts is a prerequisite for finding unit fractions of quantities ([3F-2](#)).

3MD-1 Example assessment questions

1. Circle the expressions that match the picture.

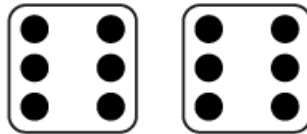

2×6	6×6	6×2
$2 + 6$	$6 + 2$	$6 + 6$

2. If one sweet costs 3p, how much do 8 sweets cost?
3. I need to buy 32 metres of fencing to go around my garden. The fencing is sold in 8-metre lengths. How many 8-metre lengths do I need to buy?
4. There are 24 strawberries in a tub. I share them equally between the 4 people in my family. How many does each person get?
5. A gardener has 5 plant pots. She plants 6 seeds in each pot. How many seeds does she plant altogether?

3F–1 Use and understand fraction notation

Interpret and write proper fractions to represent 1 or several parts of a whole that is divided into equal parts.

3F–1 Teaching guidance

Pupils should learn that when a whole is divided into equal parts, fraction notation can be used to describe the size of each equal part relative to the whole. Because it is the size of a part relative to the whole which determines the value of a fraction, it is important that pupils talk about, and identify, both the whole and the part from the start of their work on fractions. They should not begin, for example, by talking about ‘1 out of 3 parts’ without reference to a whole.

Pupils should begin by working with concrete resources and diagrams. First they should learn to identify the whole and the number of equal parts, then to describe one particular equal part relative to the whole.

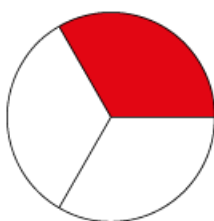

Figure 90: a circle divided into 3 equal parts, with one part shaded

Language focus

“The whole is divided into 3 equal parts. 1 of these parts is shaded.”

Pupils must be able to use this precise language to describe a unit fraction of a:

- shape/area (as in the above example)
- measure (for example, a length of ribbon or a beaker of water)
- set (for example, a group of sheep where all are white except one, which is black)

Pupils should then learn to interpret and write unit fractions, relating to these contexts, using mathematical notation. They should continue to describe the whole, the number of parts and the particular part, and relate this to the written fraction.

Say	Write
"The whole has been divided..."	The fraction bar: –
"...into 3 equal parts."	The denominator: 3
"1 of these parts is shaded."	The numerator: 1

Language focus

"The whole is divided into 3 equal parts. Each part is one-third of the whole."

A clear understanding of unit fractions is the foundation for all future fractions concepts. Pupils should spend sufficient time working with unit fractions to achieve mastery before moving on to non-unit fractions.

Pupils should learn that a non-unit fraction is made up of a quantity of unit fractions. They should practise using unitising language to describe, for example, 5 eighths as 5 one-eighths (here, we are unitising in eighths).

Language focus

"The whole is divided into 8 equal parts and 5 of those parts are shaded.

$\frac{5}{8}$ of the shape is shaded. $\frac{5}{8}$ is 5 one-eighths."

Pupils should also experience examples where all parts of the shape are shaded (or all parts of the measure or set are highlighted) and the numerator is equal to the denominator. They should understand, for example that $\frac{5}{5}$ represents all 5 equal parts, and is equivalent to the whole.

Teaching should draw attention to the fact that in order to identify a fraction, the parts need to be equal. Comparing situations where the parts are equal and those where they are not is a useful activity (see [3F-1](#), questions 2 and 4).

Making connections

Showing, describing and representing a unit fraction of a shape, measure or set involves dividing it into a number of equal parts. The theme of dividing a quantity into a given number of equal parts runs through many topics, including:

- partitive division ([3MD-1](#))
- finding a unit fraction of a value using known division facts ([3F-2](#)).

3F-1 Example assessment questions

1. What fraction of each diagram is shaded?

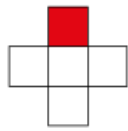

2. Does each diagram show the given fraction? Explain your answers.

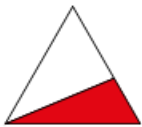

Is $\frac{1}{2}$ shaded?



Is $\frac{1}{3}$ shaded?

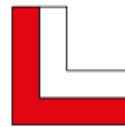

Is $\frac{1}{2}$ shaded?

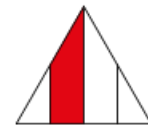

Is $\frac{1}{4}$ shaded?



Is $\frac{1}{3}$ shaded?

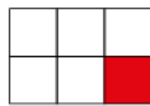

Is $\frac{1}{5}$ shaded?



Is $\frac{1}{8}$ shaded?

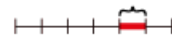

Is $\frac{1}{6}$ shaded?

3. What fraction of each diagram is shaded/highlighted?

a.

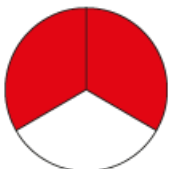

b.

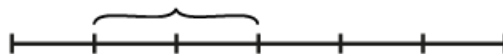

c.



4. Tick or cross each diagram to show whether $\frac{3}{5}$ is shaded. Explain your answers.

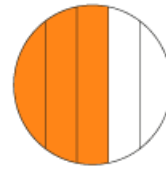
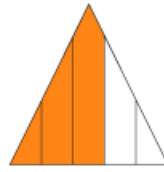

5. a. Shade $\frac{1}{10}$ of this set.

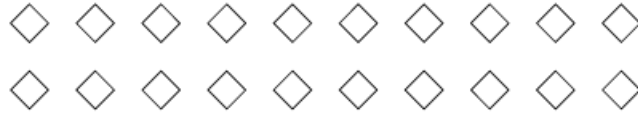

b. Shade $\frac{3}{4}$ of this shape.

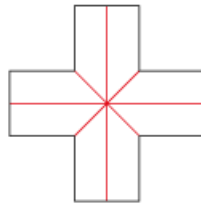

c. Circle $\frac{4}{5}$ of the flowers.

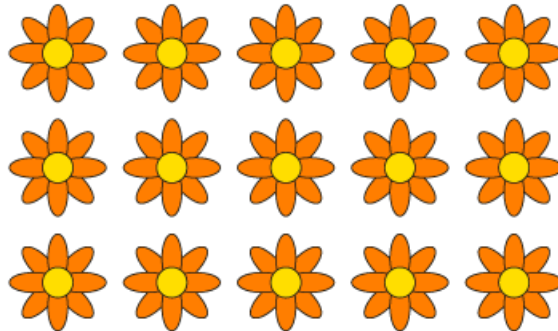

d. Colour $\frac{1}{3}$ of the line.



3F–2 Find unit fractions of quantities

Find unit fractions of quantities using known division facts (multiplication tables fluency).

3F–2 Teaching guidance

In **3F–1** pupils learnt how fractions act as operators on a whole. Now they must learn to evaluate the outcome of that operation, for unit fractions of quantities, and connect this to what they already know about dividing quantities into equal parts using known division facts, for example:

$$\begin{array}{l} 30 \div 10 = 3 \\ \text{so} \\ \frac{1}{10} \text{ of } 30 = 3 \end{array}$$

$$\begin{array}{l} 36 \div 4 = 9 \\ \text{so} \\ \frac{1}{4} \text{ of } 36 = 9 \end{array}$$

In year 3, pupils learn the 5, 10, 2, 4 and 8 multiplication tables, so examples in this criterion should be restricted to finding $\frac{1}{5}$, $\frac{1}{10}$, $\frac{1}{2}$, $\frac{1}{4}$ or $\frac{1}{8}$ of quantities. This allows pupils to focus on the underlying concepts instead of on calculation.

Pupils should begin by working with concrete resources or diagrams representing sets. As in **3F–1**, they should identify the whole, the number of equal parts, and the size of each part relative to the whole written as a unit fraction. They should then extend their description to quantify the number of items in a part, and connect this to the unit-fraction operator.

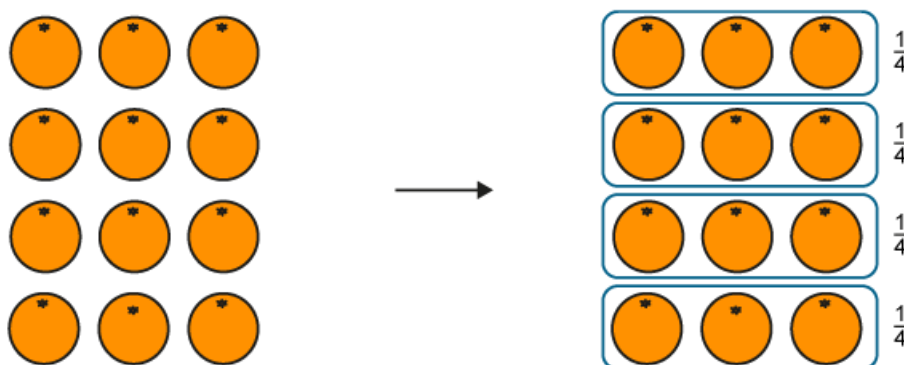

Figure 91: 12 oranges divided into 4 equal parts

Language focus

“The whole is 12 oranges. The whole is divided into 4 equal parts.”

“Each part is $\frac{1}{4}$ of the whole. $\frac{1}{4}$ of 12 oranges is 3 oranges.”

Once pupils can confidently and accurately describe situations where the value of a part is visible, they should learn to calculate the value of a part when it cannot be seen. Bar models are a useful representation here. Pupils should calculate the size of the parts using known division facts, initially with no reference to unit fractions. This is partitive division ([3MD-1](#)).

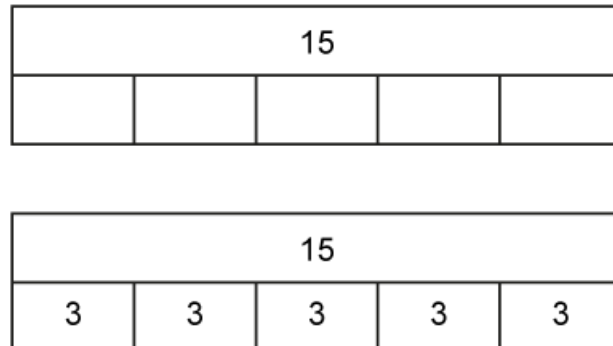

Figure 92: using a bar model to represent 15 divided into 5 equal parts

Then pupils should make the link between partitive division and finding a fraction of a quantity. They should understand that the situations are the same because both involve dividing a whole into a given number of equal parts. Pupils must understand that, therefore, division facts can be used to find a unit fraction of a quantity.

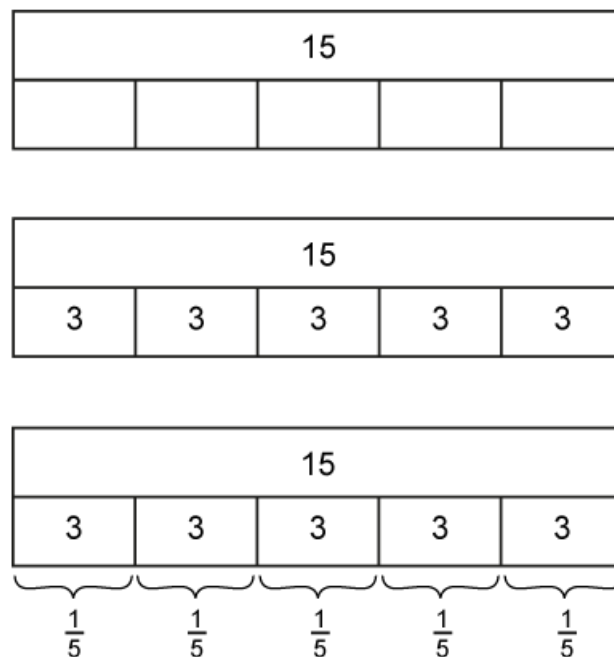

Figure 93: using a bar model to represent one-fifth of 15

Language focus

“To find $\frac{1}{5}$ of 15, we divide 15 into 5 equal parts.”

“15 divided by 5 is equal to 3, so $\frac{1}{5}$ of 15 is equal to 3.”

Making connections

This criterion builds directly on [3F-1](#), where pupils learnt to associate fraction notation with dividing a shape, measure or set into a number of equal parts.

The focus of this criterion is understanding that finding a unit fraction of a quantity is the same structure as partitive division ([3MD-1](#)).

In [3NF-1](#) pupils develop fluency in the 5, 10, 2, 4 and 8 multiplication tables and associated division facts. These division facts are applied here to find $\frac{1}{5}$, $\frac{1}{10}$, $\frac{1}{2}$, $\frac{1}{4}$ or $\frac{1}{8}$ of quantities.

3F-2 Example assessment questions

1. Rohan saved £32. He spends $\frac{1}{4}$ of his money on a toy. How much does he spend?
2. Find:
 - a. $\frac{1}{5}$ of 35
 - b. $\frac{1}{10}$ of 40
 - c. $\frac{1}{8}$ of 24
3. The school caretaker buys 50 litres of paint. She uses $\frac{1}{5}$ of it to paint the year 3 classroom. How many litres of paint is this?
4. There are 16 apples in a fruit bowl. Some children eat $\frac{1}{4}$ of the apples. How many are left?

3F–3 Fractions within 1 in the linear number system

Reason about the location of any fraction within 1 in the linear number system.

3F–3 Teaching guidance

So far (in [3F–1](#) and [3F–2](#)) pupils will probably have only experienced fractions as operators, for example, $\frac{1}{3}$ of this shape, $\frac{3}{5}$ of this line, or $\frac{1}{4}$ of this quantity. Pupils must also develop an understanding of fractions as numbers, each of which has a place in the linear number system (for example, the number $\frac{1}{4}$ in contrast to the operator $\frac{1}{4}$ of something). Pupils will already have learnt to place whole numbers on number lines, and now they must learn that other numbers (fractions) lie between these whole numbers, beginning in year 3 with fractions within 1.

Pupils should learn to count, forwards and backwards, in multiples of unit fractions, with the support of number lines.

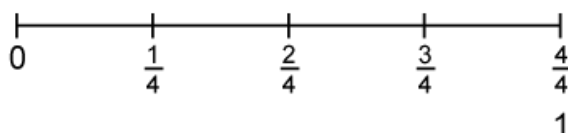

Figure 94: number line to support counting to 1 in multiples of one quarter

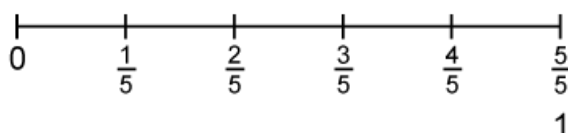

Figure 95: number line to support counting to 1 in multiples of one fifth

Pupils should practise dual counting.

Language focus

“One fifth, two fifths, three fifths...”

“1 one-fifth, 2 one-fifths, 3 one-fifths...”

This reinforces the understanding that non-unit fractions are repeated additions of unit fractions.

Pupils also need to understand that a fraction with the numerator equal to the denominator is equivalent to 1. Practice should involve counting, for example, both "... three-fifths, four-fifths, five-fifths" and "... three-fifths, four-fifths, one".

Pupils should then learn to label marked number lines, within 1. Identifying points between labelled intervals is an important skill in graphing and measures. A common mistake that pupils make is to count the number of marks between labelled intervals, rather than the number of parts, for example, on the number line below they may count 3 marks and incorrectly deduce that the number line is marked in thirds.

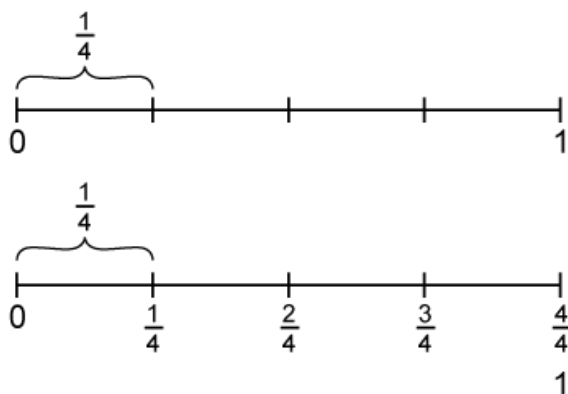

Figure 96: labelling a 0 to 1 number line marked in quarters

Language focus

"Each whole-number interval is divided into 4 equal parts, so we count in quarters."

Pupils must also be able to estimate the value or position of fractions on 0 to 1 number lines that do not have fractional marks.

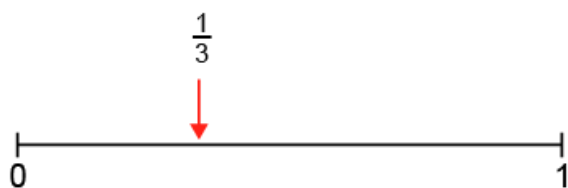

Figure 97: estimating the position of a fraction on a 0 to 1 number line

Pupils also need to be able to reason, for example, that $\frac{1}{4}$ is nearer to 0 than $\frac{1}{3}$ is, because $\frac{1}{4}$ is smaller than $\frac{1}{3}$; they should consider the number of parts the 0 to 1 interval is divided into, and understand that the greater the denominator, the more parts there are, and therefore $\frac{1}{4} < \frac{1}{3}$.

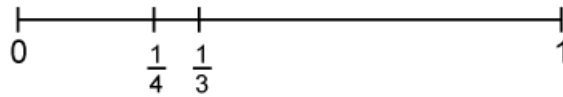

Figure 98: estimating the relative positions of one quarter and one third on a 0 to 1 number line

Making connections

Having a visual image of fractions in the linear number system helps pupils to add and subtract fractions with the same denominator, for example $\frac{5}{6} - \frac{3}{6}$ (3F-4). It also supports comparison of fractions, and reading scales.

3F-3 Example assessment questions

1. Label the points on this number line.

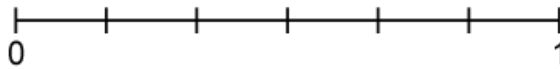

2. How tall is this plant? Give your answer as a fraction of a metre.

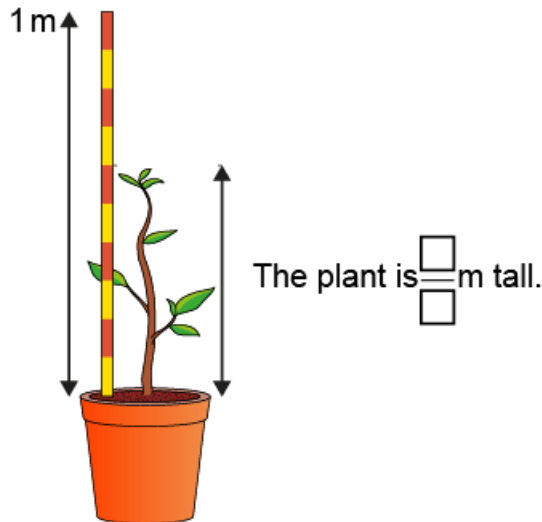

3. a. Which is larger, $\frac{6}{8}$ or $\frac{3}{8}$? Explain your answer.
- b. Which is larger, $\frac{1}{4}$ or $\frac{1}{3}$? Explain your answer.

4. Gemma and Kasper look at this number line.

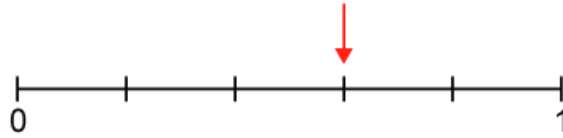

Gemma says the arrow is pointing to the number $\frac{3}{4}$.

Kasper says the arrow is pointing to the number $\frac{3}{5}$.

Who is correct? Explain your answer.

5. Add the missing labels to the measuring jug.

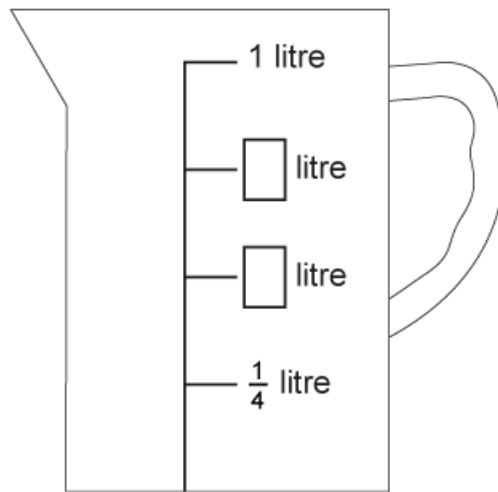

3F–4 Add and subtract fractions within 1

Add and subtract fractions with the same denominator, within 1.

3F–4 Teaching guidance

To add and subtract fractions, pupils must already understand that non-unit fractions are repeated additions of unit fractions, for example, three-eighths is 3 one-eighths. In other words, pupils must have begun to unitise with unit fractions in the same way that they learnt to unitise, for example, in tens (30 is 3 tens). Addition and subtraction of fractions with the same denominator then follows logically: just as pupils learnt that 3 tens plus 2 tens is 5 tens, they can reason that 3 one-eighths plus 2 one-eighths is equal to 5 one-eighths.

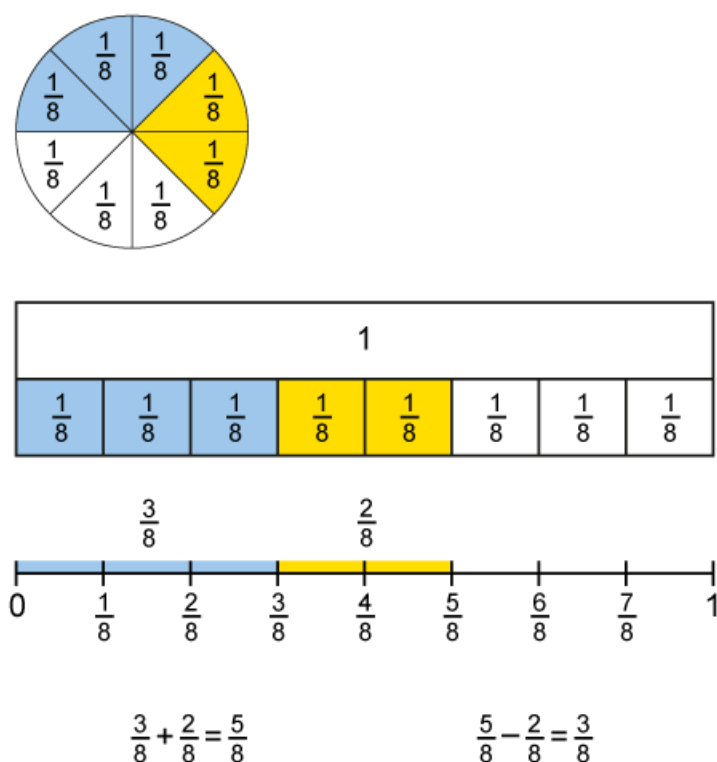

Figure 99: adding and subtracting fractions with the same denominator: pie model, bar model and number line

Language focus

“3 one-eighths plus 2 one-eighths is equal to 5 one-eighths.”

“5 one-eighths minus 2 one-eighths is equal to 3 one-eighths.”

Pupils should be able to understand and use the following generalisations.

Language focus

“When adding fractions with the same denominators, just add the numerators.”

“When subtracting fractions with the same denominators, just subtract the numerators.”

Making connections

In [3F-1](#) and [3F-3](#), pupils learnt that non-unit fractions are made up of multiples of a unit fraction. This criterion is based on pupils being able to unitise with unit fractions. Pupils already learnt to unitise in tens and combine this understanding with known addition and subtraction facts in [3NPV-1](#) and [3NF-3](#).

3F-4 Example assessment questions

1. Complete the calculations.

$$\frac{5}{9} + \frac{1}{9} = \frac{\square}{\square}$$

$$\frac{6}{8} - \frac{2}{8} = \frac{\square}{\square}$$

$$\frac{5}{12} + \frac{3}{12} = \frac{\square}{\square}$$

$$\frac{9}{11} - \frac{6}{11} = \frac{\square}{\square}$$

$$\frac{5}{14} + \frac{7}{14} = \frac{\square}{\square}$$

$$\frac{9}{10} - 0 = \frac{\square}{\square}$$

2. Diego writes:

$$\frac{3}{12} + \frac{5}{12} = \frac{8}{12}$$

Mark writes:

$$\frac{3}{12} + \frac{5}{12} = \frac{8}{24}$$

Who is correct? Explain the mistake that has been made.

3. Decide whether each calculation is correct or not. Explain your answers.

	Correct (✓) or incorrect (✗)?	Explanation
$\frac{7}{12} - \frac{2}{12} = \frac{5}{12}$		
$\frac{4}{7} - \frac{2}{7} = \frac{2}{0}$		
$\frac{8}{10} - \frac{2}{10} - \frac{1}{10} = \frac{3}{10}$		
$\frac{7}{9} - \frac{7}{9} = 0$		
$\frac{5}{8} - \frac{2}{8} - \frac{2}{8} = \frac{1}{8}$		

4. Sofia had a jug containing $\frac{7}{10}$ of a litre of juice. She drank $\frac{4}{10}$ of a litre. How much does she have left?

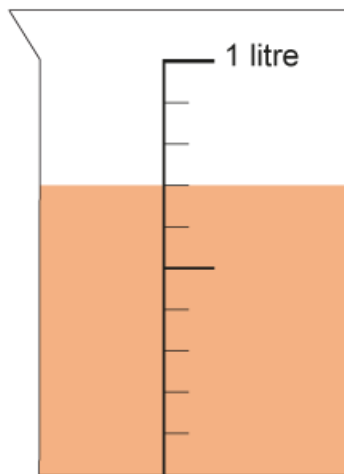

3G–1 Recognise right angles

Recognise right angles as a property of shape or a description of a turn, and identify right angles in 2D shapes presented in different orientations.

3G–1 Teaching guidance

Pupils must have learnt about fractions before beginning work on this criterion. In particular they should recognise one-, two- and three-quarters of a circle.

Pupils must be able to describe and represent quarter, half and three-quarter turns (clockwise and anti-clockwise). Pupils should begin by making quarter turns with their bodies, following instructions such as “Stand, and make a quarter turn clockwise. Walk in a straight line. Stop. Make a quarter turn anticlockwise.” They should be able to relate these movements to the quarter turn of a clock hand. Pupils should learn that the angle relative to the starting orientation, created by a quarter turn (in either direction), is called a right angle – programmable robots and geo-strips are useful tools for illustrating this.

Pupils should then learn to follow instructions involving $\frac{1}{2}$ turn and $\frac{3}{4}$ turns, clockwise and anticlockwise. They should recognise that the result of making a $\frac{1}{2}$ turn clockwise is the same as the result of making a $\frac{1}{2}$ turn anticlockwise. Pupils should also understand $\frac{1}{2}$ and $\frac{3}{4}$ turns as repeated $\frac{1}{4}$ turns, and therefore as repeated turns through a right angle.

Pupils should recognise that a right angle is the ‘amount of turn’ between 2 lines, and is independent of the length of those lines. They should be presented with a right angle created by 2 long lines (such as two metre sticks) and a right angle created by 2 short lines (such as 2 geo-strips), and understand that both are right angles. It is important that pupils know that it is incorrect to describe the right-angle made from longer lines as a ‘bigger right angle’, or that made from the shorter lines as a ‘smaller right angle’.

Pupils should practise identifying right angles in their environment, for example, the corner of their desk, the panes of a window, or the hands on a clock at 3pm or 9pm. They should learn to use various tools to confirm that angles are right angles, for example a card circle with a quarter circle cut out, or a piece of paper of any size that has been folded in half and half again to create a right angle.

Pupils must then learn to identify right angles in polygons. This should involve both handling shapes (for example, cut from cardboard) and working with images of shapes. When pupils are handling shapes, they should practise rotating the shapes to check each angle against a right-angle checker. Images of shapes should be presented in a variety of orientations, so that pupils’ ability to identify right angles is not dependent on the lines being horizontal and vertical. Pupils must also learn to interpret and use the standard convention for marking right angles (as illustrated below).

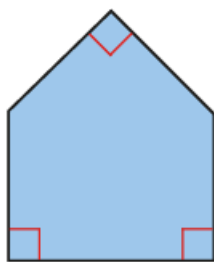

Figure 100: irregular pentagon with 3 right angles marked using standard convention

Whether working with cut-out shapes or images, pupils should be able to state whether a given angle is greater than or smaller than a right angle, using the angle-checker.

Pupils should recognise that:

- the only polygon in which every vertex can be a right angle is a quadrilateral
- quadrilaterals that have 4 right angles are rectangles irrespective of the length of their sides
- a quadrilateral that has all side-lengths equal and every vertex a right angle is a regular rectangle that can also be called a square

Making connections

In **3G-2**, children will learn that 2 lines are at right angles are termed 'perpendicular'. Composing and drawing shapes in **3G-2** provides another context in which to identify right angles.

3G–1 Example assessment questions

1. Here is a map of a treasure island.



a. Follow the instructions and say where you end up. Each time, start at the camp, facing north.

i. Go forwards 3 squares.
Make a quarter turn clockwise.
Go forwards 2 squares.
Make a quarter turn anticlockwise.
Go forwards 2 squares.
Where are you?

ii. Make a three-quarter turn clockwise.
Go forward 3 squares.
Make a quarter turn anticlockwise.
Go forward 1 square.
Where are you?

b. Start at the camp, facing North. Write some instructions, like the ones above, to get to the treasure.

2. Draw an irregular hexagon with one right angle on this grid.



3. Mark all of the right angles in these shapes. Use a right-angle checker to help you.

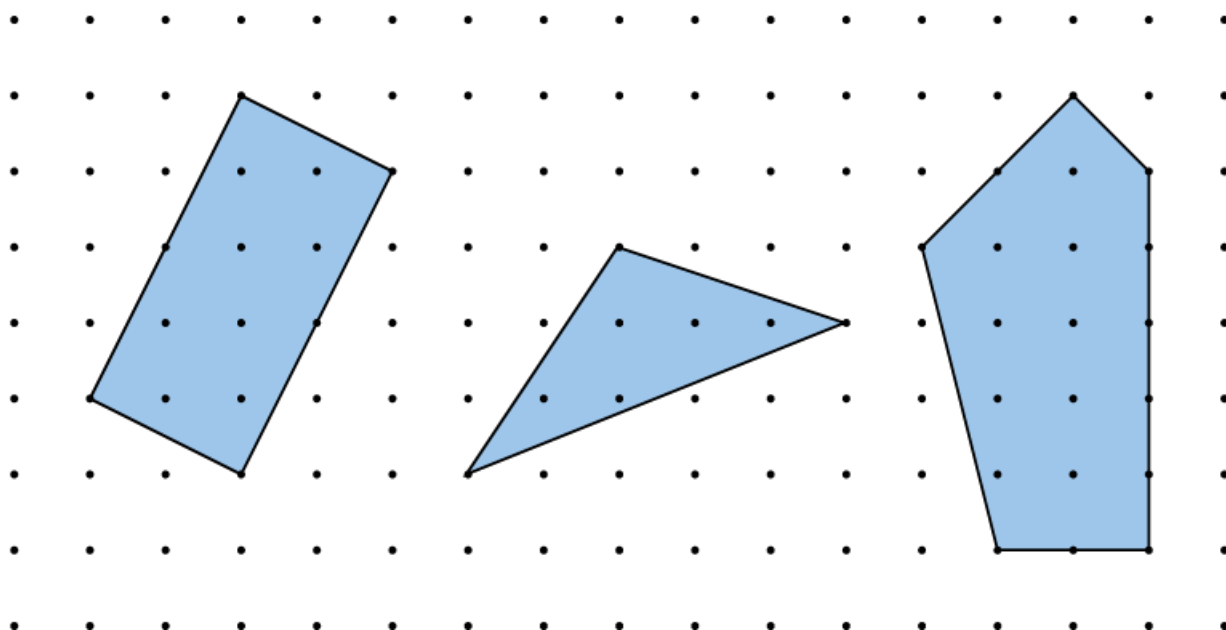

3G–2 Draw polygons and identify parallel and perpendicular sides

Draw polygons by joining marked points, and identify parallel and perpendicular sides.

3G–2 Teaching guidance

Pupils must learn to draw polygons by joining marked points, precisely, using a ruler. Pupils should be able to mark vertices themselves on a grid (square or isometric), as well as join already-marked points.

Pupils must be able to identify a pair of parallel or perpendicular lines, as well as horizontal and vertical lines. They should be able to explain why a pair of lines are parallel or perpendicular.

Language focus

“These 2 lines are parallel because they are always the same distance apart. They will never meet no matter how far we extend them.”

“These 2 lines are perpendicular because they are at right angles to each other.”

Pupils should be able to select or create shapes according to parameters that include these terms, such as joining 2 isosceles triangles to make a parallelogram.

Pupils may use standard notation to mark parallel sides.

Making connections

In **3G–1**, children learnt to identify right angles. In this criterion they should identify right angles in shapes they have drawn or made, and know that a right angle is made at the point where two perpendicular lines meet.

3G–2 Example assessment questions

1. Task: Provide each pupil with 2 trapezium pieces from a pattern block set. Then ask them to make 3 different shapes by joining the pieces and discuss the properties of each shape they make.
2. Here are 5 vertices of a regular hexagon. Mark the sixth vertex and join the points to draw the hexagon.

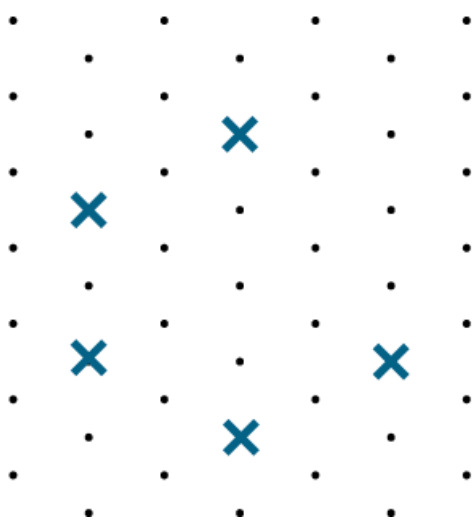

3. Here are 2 sides of a square. Complete the square.

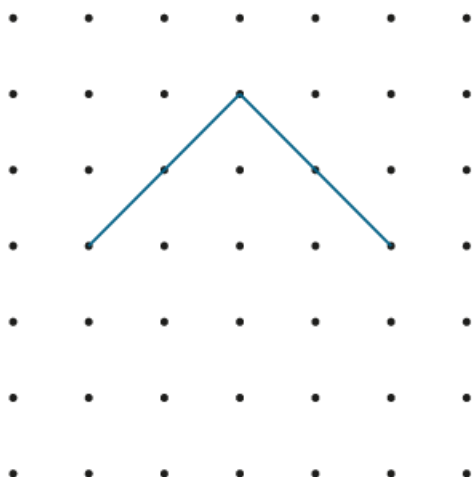

4. Look at these 5 quadrilaterals. Mark all the pairs of parallel sides. Hint: you can extend sides to help you.

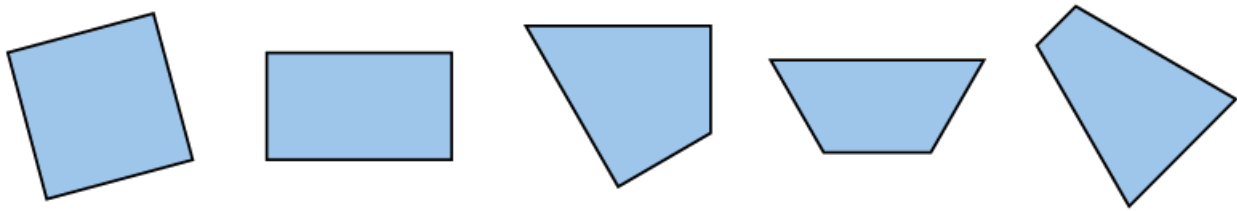

5. Mark the missing vertex of this quadrilateral so that 2 of the sides are perpendicular.

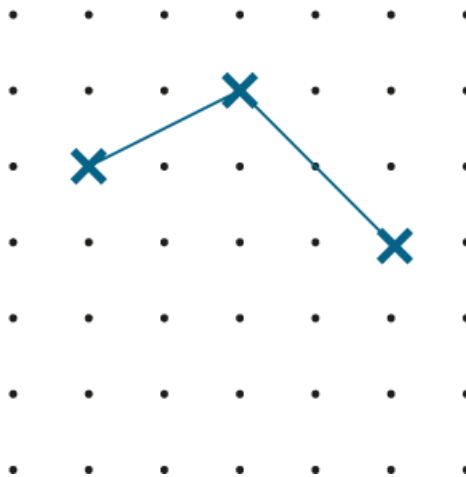

Calculation and fluency

Number, place value and number facts: 3NPV-2 and 3NF-3

- **3NPV-2:** Recognise the place value of each digit in *three*-digit numbers, and compose and decompose *three*-digit numbers using standard and non-standard partitioning.
- **3NF-3:** Apply place-value knowledge to known additive and multiplicative number facts (scaling facts by 10), for example:

$$8 + 6 = 14 \text{ and } 14 - 6 = 8$$

so

$$80 + 60 = 140 \text{ and } 140 - 60 = 80$$

$$3 \times 4 = 12 \text{ and } 12 \div 4 = 3$$

so

$$30 \times 4 = 120 \text{ and } 120 \div 4 = 30$$

Representations such as place-value counters and partitioning diagrams (**3NPV-2**), and tens-frames with place-value counters (**3F-3**), can be used initially to help pupils understand calculation strategies and make connections between known facts and related calculations. However, pupils should not rely on such representations for calculating. For the calculations in **3NF-3**, for example, pupils should instead be able to calculate by verbalising the relationship.

Language focus

“8 plus 6 is equal to 14, so 8 tens plus 6 tens is equal to 14 tens.”

“14 tens is equal to 140.”

Pupils should be developing fluency in both formal written and mental methods for addition and subtraction. Mental methods can include jottings to keep track of calculation, or language structures as exemplified above. Pupils should select the most efficient method to calculate depending on the numbers involved.

3NF–1 Fluently add and subtract within and across 10

Secure fluency in addition and subtraction facts that bridge 10, through continued practice.

Pupils who are fluent in addition and subtraction facts within and across 10 have the best chance of mastering columnar addition and columnar subtraction. Teachers should make sure that fluency in addition and subtraction facts is given the same prominence as fluency in multiplication tables.

Pupils should continue to practise calculating with additive facts within 10.

Pupils may initially use manipulatives, such as tens frames and counters, to apply the strategies for adding and subtracting across 10 described in year 2 ([2AS–1](#)). However, they should not be using the manipulatives as a tool for finding answers, and by the end of year 3 pupils should be able to carry out these calculations mentally, using their fluency in complements to 10 and partitioning.

Pupils do not need to memorise all additive facts for adding and subtracting across 10, but need to be able to recall appropriate doubles (double 6, 7, 8 and 9) and corresponding halves (half of 12, 14, 16 and 18), and use these known facts for calculations such as $6 + 6 = 12$ and $18 - 9 = 9$.

3AS–2 Columnar addition and subtraction

Add and subtract up to three-digit numbers using columnar methods.

Pupils must be able to add 2 or more numbers using columnar addition, including calculations whose addends have different numbers of digits.

$$\begin{array}{r} 274 \\ + 354 \\ \hline 628 \\ 1 \end{array}$$
$$\begin{array}{r} 62 \\ + 481 \\ \hline 543 \\ 1 \end{array}$$
$$\begin{array}{r} 186 \\ 57 \\ + 434 \\ \hline 677 \\ 11 \end{array}$$

Figure 101: columnar addition for calculations involving three-digit numbers

For calculations with more than 2 addends, pupils should add the digits within a column in the most efficient order. For the third example above, efficient choices could include:

- beginning by making 10 in the ones column
- making double 8 in the tens column

Pupils must be able to subtract 1 three-digit number from another using columnar subtraction. They should be able to apply the columnar method to calculations where the subtrahend has fewer digits than the minuend, and they must be able to exchange through 0.

$$\begin{array}{r} \overset{5}{\cancel{6}} \overset{1}{2} 8 \\ - 274 \\ \hline 354 \end{array}$$
$$\begin{array}{r} \overset{4}{\cancel{5}} \overset{14}{\cancel{5}} 6 \\ - 78 \\ \hline 478 \end{array}$$
$$\begin{array}{r} \overset{2}{\cancel{3}} \overset{9}{\cancel{0}} 2 \\ - 154 \\ \hline 148 \end{array}$$

Figure 102: columnar subtraction for calculations involving three-digit numbers

Pupils should make sensible decisions about how and when to use columnar subtraction. For example, when the minuend and subtrahend are very close together pupils may mentally find the difference, avoiding the need for column subtraction. For example, for $402 - 398$, pupils can see that 398 is 2 away from 400, and then there is 2 more to get to 402, so the difference is 4. This is more efficient than the corresponding columnar subtraction calculation which requires exchange through the zero.

3NF–2 Recall of multiplication tables

Recall multiplication facts, and corresponding division facts, in the 10, 5, 2, 4 and 8 multiplication tables, and recognise products in these multiplication tables as multiples of the corresponding number.

Pupils who are fluent in these multiplication table facts can solve the following types of problem by automatic recall of the relevant fact rather than by skip counting or reciting the relevant multiplication table:

- identifying products

$8 \times 4 = \square$

$\square = 3 \times 5$

$10 \times 10 = \square$

- solving missing-factor problems

$\square \times 5 = 45$

$6 \times \square = 48$

$22 = \square \times 2$

- using relevant multiplication table facts to solve division problems

$35 \div 5 = \square$

$\square = 40 \div 8$

Pupils should also be fluent in interpreting contextual multiplication and division problems, identifying the appropriate calculation and solving it using automatic recall of the relevant fact. This is discussed, and example questions are given, in [3MD–1](#).

As pupils become fluent with the multiplication table facts, they should also develop fluency in related calculations as described in [3NF–3](#) (scaling number facts by 10).

Year 4 guidance

Ready-to-progress criteria

Year 3 conceptual prerequisite	Year 4 ready-to-progress criteria	Future applications
Know that 10 tens are equivalent to 1 hundred, and that 100 is 10 times the size of 10.	4NPV-1 Know that 10 hundreds are equivalent to 1 thousand, and that 1,000 is 10 times the size of 100; apply this to identify and work out how many 100s there are in other four-digit multiples of 100.	Solve multiplication problems that involve a scaling structure, such as '10 times as long'.
Recognise the place value of each digit in <i>three</i> -digit numbers, and compose and decompose <i>three</i> -digit numbers using standard and non-standard partitioning.	4NPV-2 Recognise the place value of each digit in <i>four</i> -digit numbers, and compose and decompose <i>four</i> -digit numbers using standard and non-standard partitioning.	Compare and order numbers. Add and subtract using mental and formal written methods.
Reason about the location of any <i>three</i> -digit number in the linear number system, including identifying the previous and next multiple of 10 and 100.	4NPV-3 Reason about the location of any <i>four</i> -digit number in the linear number system, including identifying the previous and next multiple of 1,000 and 100, and rounding to the nearest of each.	Compare and order numbers. Estimate and approximate to the nearest multiple of 1,000, 100 or 10.
Divide 100 into 2, 4, 5 and 10 equal parts, and read scales/number lines marked in multiples of 100 with 2, 4, 5 and 10 equal parts.	4NPV-4 Divide 1,000 into 2, 4, 5 and 10 equal parts, and read scales/number lines marked in multiples of 1,000 with 2, 4, 5 and 10 equal parts.	Read scales on graphs and measuring instruments.
Recall multiplication and division facts in the 5 and 10, and 2, 4 and 8 multiplication tables, and recognise products in these multiplication tables as multiples of the corresponding number.	4NF-1 Recall multiplication and division facts up to 12×12 , and recognise products in multiplication tables as multiples of the corresponding number.	Use multiplication facts during application of formal written methods. Use division facts during application of formal written methods.

Year 3 conceptual prerequisite	Year 4 ready-to-progress criteria	Future applications
<p>Use known division facts to solve division problems.</p> <p>Calculate small differences, for example:</p> $74 - 72 = 2$	<p>4NF-2 Solve division problems, with two-digit dividends and one-digit divisors, that involve remainders, for example:</p> $74 \div 9 = 8 \text{ r } 2$ <p>and interpret remainders appropriately according to the context.</p>	<p>Correctly represent and interpret remainders when using short and long division.</p>
<p>Apply place-value knowledge to known additive and multiplicative number facts (scaling facts by 10), for example:</p> $80 + 60 = 140$ $140 - 60 = 80$ $30 \times 4 = 120$ $120 \div 4 = 30$	<p>4NF-3 Apply place-value knowledge to known additive and multiplicative number facts (scaling facts by 100), for example:</p> $8 + 6 = 14 \text{ and } 14 - 6 = 8$ <p>so</p> $800 + 600 = 1,400$ $1,400 - 600 = 800$ $3 \times 4 = 12 \text{ and } 12 \div 4 = 3$ <p>so</p> $300 \times 4 = 1,200$ $1,200 \div 4 = 300$	<p>Apply place-value knowledge to known additive and multiplicative number facts, extending to a whole number of larger powers of ten and powers of ten smaller than one, for example:</p> $800,000 + 600,000 = 1,400,000$ $1,400,000 - 600,000 = 800,000$ $0.03 \times 4 = 0.12$ $0.12 \div 4 = 0.03$
<p>Multiply two-digit numbers by 10, and divide three-digit multiples of 10 by 10.</p>	<p>4MD-1 Multiply and divide whole numbers by 10 and 100 (keeping to whole number quotients); understand this as equivalent to making a number 10 or 100 times the size.</p>	<p>Convert between different metric units of measure.</p> <p>Apply multiplication and division by 10 and 100 to calculations involving decimals, for example:</p> $0.03 \times 100 = 3$ $3 \div 100 = 0.03$
<p>Understand the inverse relationship between multiplication and division.</p> <p>Write and use multiplication table facts with the factors presented in either order.</p>	<p>4MD-2 Manipulate multiplication and division equations, and understand and apply the commutative property of multiplication.</p>	<p>Recognise and apply the structures of multiplication and division to a variety of contexts.</p>
	<p>4MD-3 Understand and apply the distributive property of multiplication.</p>	<p>Recognise when to use and apply the distributive property of multiplication in a variety of contexts.</p>

Year 3 conceptual prerequisite	Year 4 ready-to-progress criteria	Future applications
Reason about the location of fractions less than 1 in the linear number system.	4F-1 Reason about the location of mixed numbers in the linear number system.	Compare and order fractions.
Identify unit and non-unit fractions.	4F-2 Convert mixed numbers to improper fractions and vice versa.	Compare and order fractions. Add and subtract fractions where calculation bridges whole numbers.
Add and subtract fractions with the same denominator, within 1 whole, for example: $\frac{2}{5} + \frac{2}{5} = \frac{4}{5}$	4F-3 Add and subtract improper and mixed fractions with the same denominator, including bridging whole numbers, for example: $\frac{7}{5} + \frac{4}{5} = \frac{11}{5}$ $3\frac{7}{8} - \frac{2}{8} = 3\frac{5}{8}$ $7\frac{2}{5} + \frac{4}{5} = 8\frac{1}{5}$ $8\frac{1}{5} - \frac{4}{5} = 7\frac{2}{5}$	
Draw polygons by joining marked points.	4G-1 Draw polygons, specified by coordinates in the first quadrant, and translate within the first quadrant.	Draw polygons, specified by coordinates in the 4 quadrants.
Measure lines in centimetres and metres. Add more than 2 addends. Recall multiplication table facts.	4G-2 Identify regular polygons, including equilateral triangles and squares, as those in which the side-lengths are equal and the angles are equal. Find the perimeter of regular and irregular polygons.	Draw, compose and decompose shapes according to given properties, dimensions, angles or area.
	4G-3 Identify line symmetry in 2D shapes presented in different orientations. Reflect shapes in a line of symmetry and complete a symmetric figure or pattern with respect to a specified line of symmetry.	Draw polygons, specified by coordinates in the 4 quadrants: draw shapes following translation or reflection in the axes.

4NPV–1 Equivalence of 10 hundreds and 1 thousand

Know that 10 hundreds are equivalent to 1 thousand, and that 1,000 is 10 times the size of 100; apply this to identify and work out how many 100s there are in other four-digit multiples of 100.

4NPV–1 Teaching guidance

4NPV–1 follows on from what children learnt in year 3 about the relationship between the units of 10 and 100 (see [3NPV–1](#)).

Pupils need to experience:

- what 1,000 items looks like
- making a unit of 1 thousand out of 10 units of 100, for example using 10 bundles of 100 straws to make 1,000, or using ten 100-value place-value counters



Figure 103: ten 100-value place-value counters in a tens frame

Language focus

“10 hundreds is equal to 1 thousand.”

Pupils must then be able to work out how many hundreds there are in other four-digit multiples of 100.



Figure 104: eighteen 100-value place-value counters in 2 tens frames

Language focus

“18 hundreds is equal to 10 hundreds and 8 more hundreds.”

“10 hundreds is equal to 1,000.”

“So 18 hundreds is equal to 1,000 and 8 more hundreds, which is 1,800.”

The reasoning here can be described as grouping or repeated addition – pupils group or add 10 hundreds to make 1,000, then add another group of 8 hundreds.

Pupils need to be able to apply this reasoning to measures contexts, as shown in the [4NPV-1](#) below. It is important for pupils to understand that there are hundreds within this new unit of a thousand, in different contexts.

Pupils should be able to explain that numbers such as 1,800 and 3,000 are multiples of 100, because they are each equal to a whole number of hundreds. They should be able to identify multiples of 100 based on the fact that they have zeros in both the tens and ones places.

As well as understanding 1,000 and other four-digit multiples of 100 in terms of grouping and repeated addition, pupils should be able to describe these numbers in terms of scaling by 10.

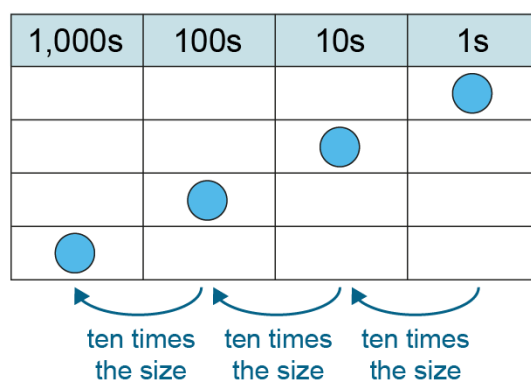

Figure 105: place-value chart illustrating the scaling relationship between ones, tens, hundreds and thousands

Language focus

“1000 is 10 times the size of 100.”

“1,800 is 10 times the size of 180.”

Making connections

Learning to identify the number of hundreds in four-digit multiples of 100 should be connected to pupils' understanding of multiplication and the grouping structure of division ([2MD-1](#)). Pupils should, for example, be able to represent 1,800 as 18 hundreds using the multiplication equations $1,800 = 18 \times 100$ or $1,800 = 100 \times 18$, and be able to write the corresponding division equations $1,800 \div 100 = 18$ and $1,800 \div 18 = 100$. Criterion [4MD-1](#) requires pupils to interpret the multiplication equations in terms of the scaling structure of multiplication, for example 1,800 is 100 times the size of 18.

4NPV-1 Example assessment questions

1. How many 100g servings of rice are there in a 2,500g bag?
2. One large desk costs a school £100. How much will 14 large desks cost?
3. My school field is 100m long. How many times do I have to run its length to run 3km?
4. My cup contains 100 ml of fizzy drink. The bottle contains 10 times as much. How many millilitres are there in the bottle?
5. A rhino mother weighs about 1,000kg. She weighs about 10 times as much as her baby. What is the approximate weight of the baby rhino?
6. Circle the lengths that could be made using 1 metre (100cm) sticks.
3,100cm 8,000cm 1,005cm 6,600cm 7,090cm 1,000cm

4NPV–2 Place value in four-digit numbers

Recognise the place value of each digit in *four*-digit numbers, and compose and decompose *four*-digit numbers using standard and non-standard partitioning.

4NPV–2 Teaching guidance

Pupils should be able to identify the place value of each digit in a four-digit number. They must be able to combine units of ones, tens, hundreds and thousands to compose four-digit numbers, and partition four-digit numbers into these units. Pupils need to experience variation in the order of presentation of the units, so that they understand that $40 + 300 + 2 + 5000$ is equal to 5,342, not 4,325.

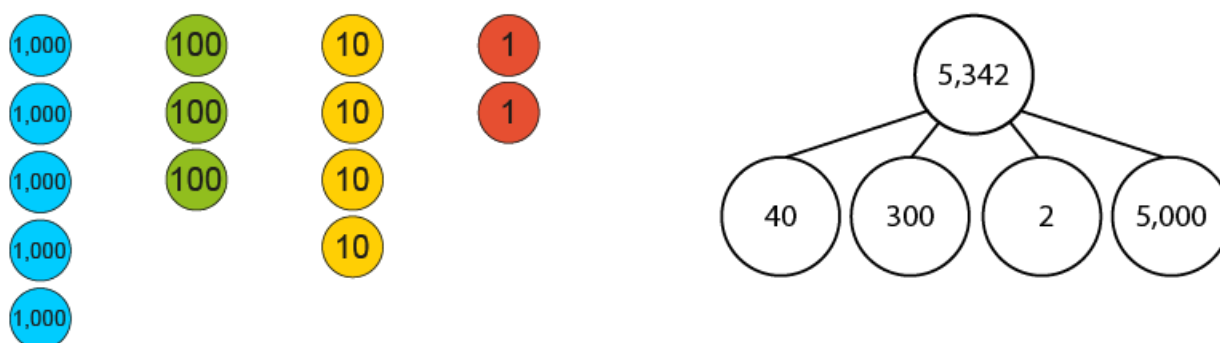

Figure 106: 2 representations of the place-value composition of 5,342

Pupils also need to solve problems relating to subtraction of any single place-value part from the whole number, for example:

$$5,342 - 300 = \square$$

$$5,342 - \square = 5,302$$

As well as being able to partition numbers in the 'standard' way (into individual place-value units), pupils must also be able to partition numbers in 'non-standard' ways, and carry out related addition and subtraction calculations, for example:

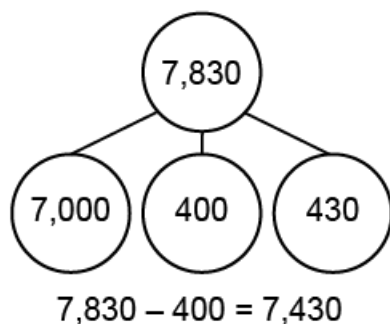

Figure 107: partitioning 7,830 into 7,430 and 400

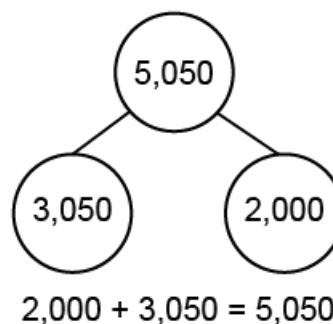

Figure 108: partitioning 5,050 into 2,000 and 3,050

4NPV–2 Example assessment questions

1. Complete the calculations.

$90 + 7 + 6,000 + 400 = \square$

$4,382 - 300 = \square$

$900 + 70 + 600 + 4 = \square$

$4,382 - 80 = \square$

$9 + 7,000 + 60 + 400 = \square$

$4,382 - 2 = \square$

$9,000 + 700 + 6 + 40 = \square$

$4,382 - 4,000 = \square$

$8,451 = 5,000 + \square$

$300 + 5,614 = \square$

$9,575 - 50 = \square$

$6,140 = 5,000 + \square + 40$

$2,000 + 1,430 + 50 = \square$

- A football stadium can hold 6,430 people. So far 4,000 tickets have been sold for a match. How many tickets are left?
- On a field trip, the children need to walk 4,200m. So far they have walked 3km. How much further do they have to walk?
- Mr. Davis has 2 cats. One cat weighs 4,200g. The other cat weighs 3,050g. Their basket weighs 2kg. How much does the basket weigh with both cats inside it?

4NPV–3 Four-digit numbers in the linear number system

Reason about the location of any *four*-digit number in the linear number system, including identifying the previous and next multiple of 1,000 and 100, and rounding to the nearest of each.

4NPV–3 Teaching guidance

Pupils need to be able to identify or place four-digit numbers on marked number lines with a variety of scales. Pupils should also be able to estimate the value or position of four-digit numbers on unmarked numbers lines, using appropriate proportional reasoning. Pupils should apply this skill to taking approximate readings of scales in measures and statistics contexts, as shown in the Example assessment questions below. For more detail on identifying, placing and estimating positions of numbers on number lines, see year 2, [2NPV–2](#).

Pupils must also be able to identify which pair of multiples of 1000 or 100 a given four-digit number is between. To begin with, pupils can use a number line for support. In this example, for the number 8,681, pupils must identify the previous and next multiples of 1,000 and 100.

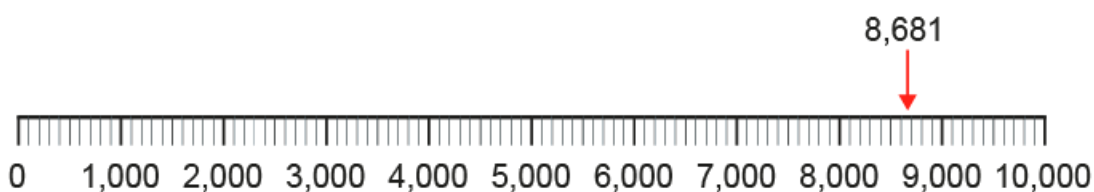

Figure 109: using a number line to identify the previous and next multiple of 1,000

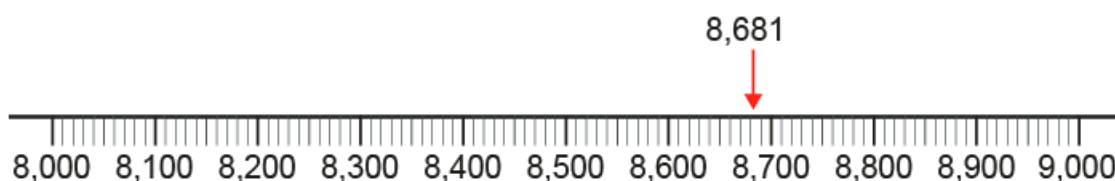

Figure 110: using a number line to identify the previous and next multiple of 100

Language focus

“The previous multiple of 1,000 is 8,000. The next multiple of 1,000 is 9,000.”

“The previous multiple of 100 is 8,600. The next multiple of 100 is 8,700.”

Pupils need to be able to identify previous and next multiples of 1000 or 100 without the support of a number line.

Pupils should then learn to round a given four-digit number to the nearest multiple of 1,000 by identifying the nearest of the pair of multiples of 1,000 that the number is between. Similarly, pupils should learn to round to the nearest multiple of 100. They should understand that they need to examine the digit in the place to the right of the multiple they are rounding to, for example when rounding to the nearest multiple of 1,000 pupils must examine the digit in the hundreds place. Again, pupils can initially use number lines for support, but should be able to round without that support by the end of year 4.



Figure 111: identifying the nearest multiple of 1,000 with a number line for support

Language focus

“The closest multiple of 1,000 is 9,000.”

“8,681 rounded to the nearest thousand is 9,000.”

Finally, pupils should also be able to count forwards and backwards from any four-digit number in steps of 1, 10 or 100. Pay particular attention to counting over ‘boundaries’, for example:

- 2,100, 2,000, 1,900
- 2,385, 2,395, 2,405

Making connections

Here, pupils must apply their knowledge that 10 hundreds is equal to 1 thousand (see [4NPV-1](#)) to understand that each interval of 1,000 on a number line or scale is made up of 10 intervals of 100. This also links to [4NPV-4](#) in which pupils need to be able to read scales divided into 2, 4, 5 and 10 equal parts. However, for the current criterion pupils are not expected to make precise placements, but instead approximate using proportional reasoning.

4NPV-3 Example assessment questions

1.

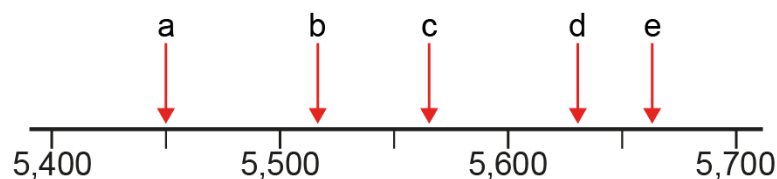

- Which 2 numbers round to 5,600 when rounded to the nearest hundred?
- Round each number to the nearest thousand.
- Estimate the value of each number.

2.

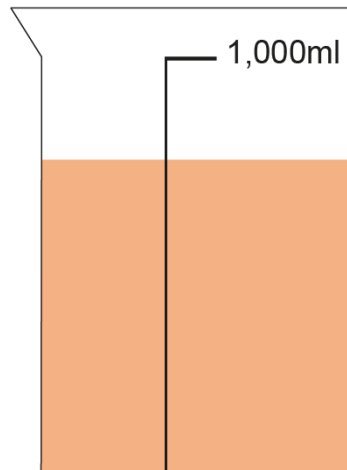

- a. Estimate how much liquid is in the beaker.
- b. Estimate how much liquid needs to be added to make 1 litre.

3. Estimate and mark the position of 600g on this scale.



4. The bar chart shows the number of red and blue cars that passed a school in one day.

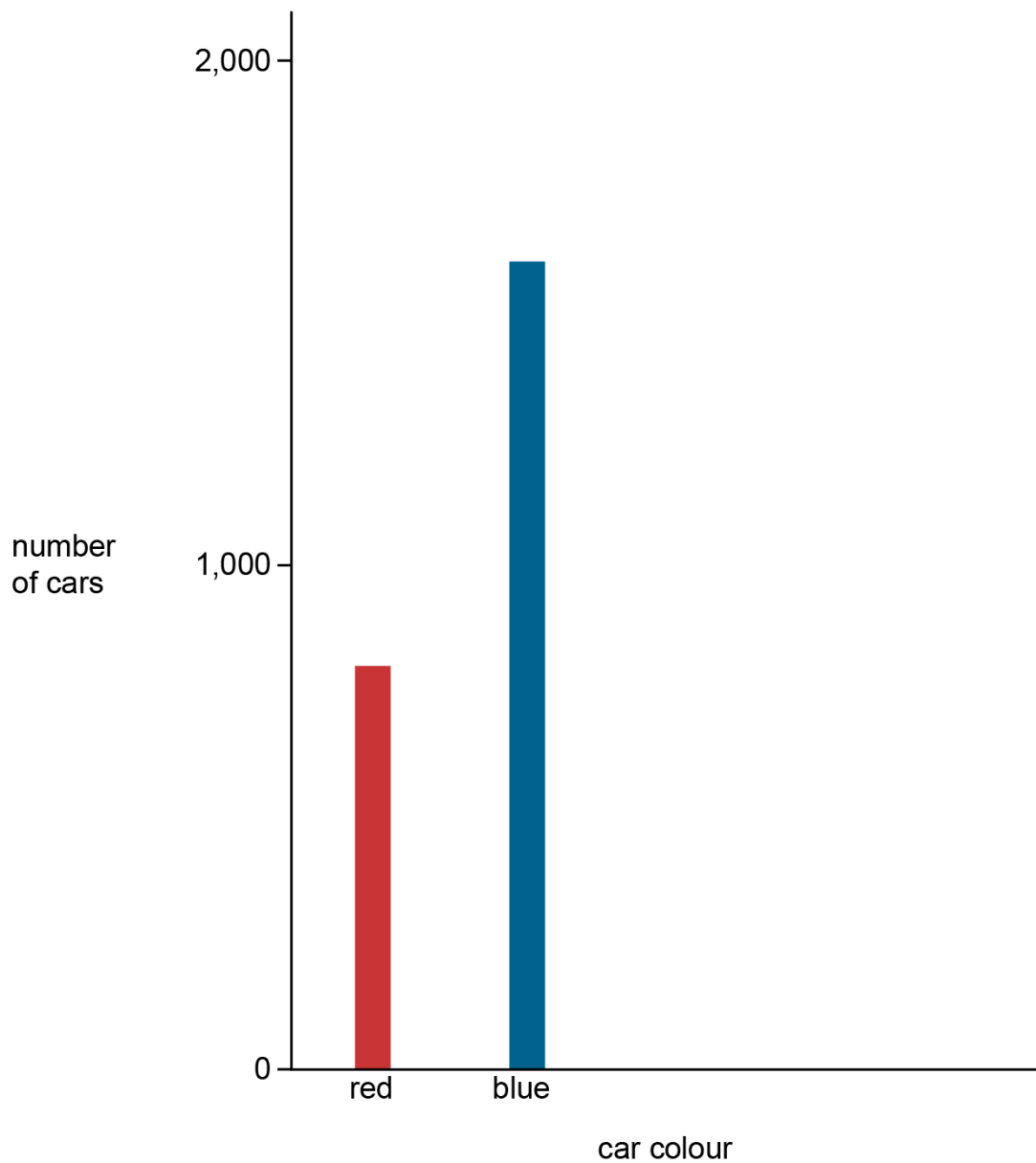

- Estimate the number of red and blue cars that passed the school on this day.
- Estimate the number of blue cars that passed the school on this day.
- Add the following data for other coloured cars to the bar chart.

	Yellow	Black	White
Number of cars	100	1,050	1,995

5. Fill in the missing numbers.

600	700		900		1,100		1,300
			5,001	5,002	5,003		
3,650			3,950			4,250	4,350
	1,075	1,085	1,095				

4NPV–4 Reading scales with 2, 4, 5 or 10 intervals

Divide 1,000 into 2, 4, 5 and 10 equal parts, and read scales/number lines marked in multiples of 1,000 with 2, 4, 5 and 10 equal parts.

4NPV–4 Teaching guidance

By the end of year 4, pupils must be able to divide 1,000 into 2, 4, 5 or 10 equal parts. This is important because these are the intervals commonly found on measuring instruments and graph scales.

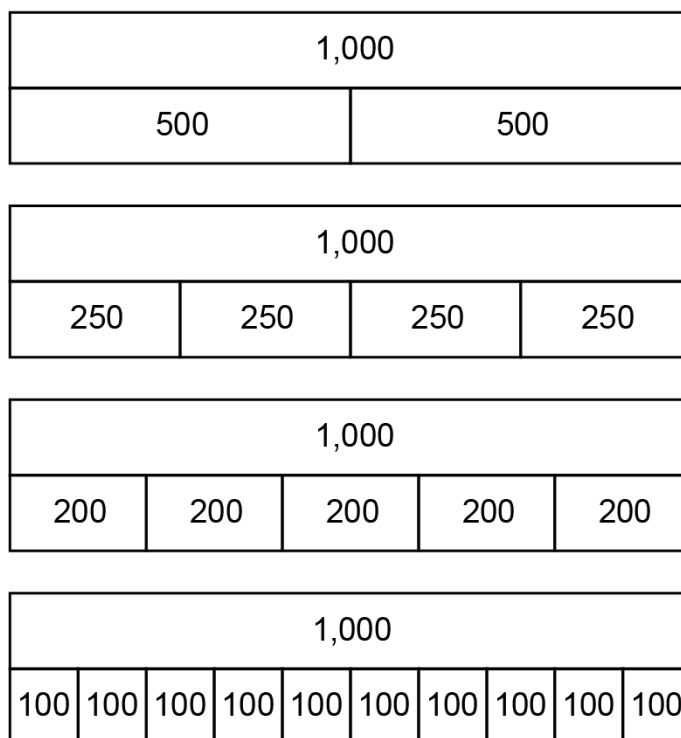

Figure 112: bar models showing 1,000 partitioned into 2, 4, 5 and 10 equal parts

Pupils should practise counting in multiples of 100, 200, 250, and 500 from 0, or from any multiple of these numbers, both forwards and backwards. This is an important step in becoming fluent with these number patterns. Pupils will have been practising counting in multiples of 1, 2 and 5 since year 1, and this supports counting in units of 100, 200 and

500. Pupils typically find counting in multiples of 250 the most challenging, because they only started to encounter this pattern in year 3, when counting in multiples of 25.

Language focus

“Twenty-five, fifty, seventy-five, one hundred” needs to be a fluent spoken language pattern. Fluency in this language pattern provides the basis to count in multiples of 250.

Pupils should be able to apply this skip counting, beyond 1,000, to solve contextual multiplication and division measures problems, as shown in the [4NPV-4](#) below (questions 5 and 7). Pupils should also be able to write and solve multiplication and division equations related to multiples of 100, 200, 250 and 500 up to 1,000.

Pupils need to be able to solve addition and subtraction problems based on partitioning 1,000 into multiples of 100, 200 and 500 based on known number bonds to 10. Pupils should also have automatic recall of the fact that 250 and 750 are bonds to 1,000. They should be able to immediately answer a question such as “I have 1 litre of water and pour out 250ml. How much is left?”

Making connections

[4MD-2](#) requires pupils to manipulate multiplication and division equations. They should therefore be able to write and manipulate multiplication and division equations related to the composition of 1,000 as discussed here.

Dividing 1,000 into 10 equal parts is also assessed as part of [4NPV-1](#).

Reading scales builds on number line knowledge from [4NPV-3](#). Conversely, experience of working with scales with 2, 4, 5 or 10 divisions in this criterion improves pupils’ estimating skills when working with unmarked number lines and scales as described in [4NPV-3](#).

4NPV-4 Example assessment questions

1. Fill in the missing numbers.

3,000		4,000	4,500	5,000	
	2,400			3,000	3,200
1,500		2,000			2,750

2. What is the reading on each of these scales?

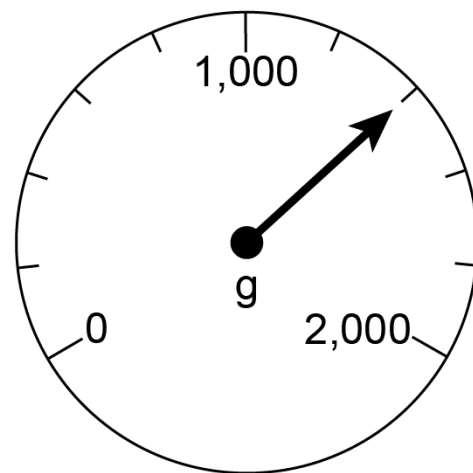
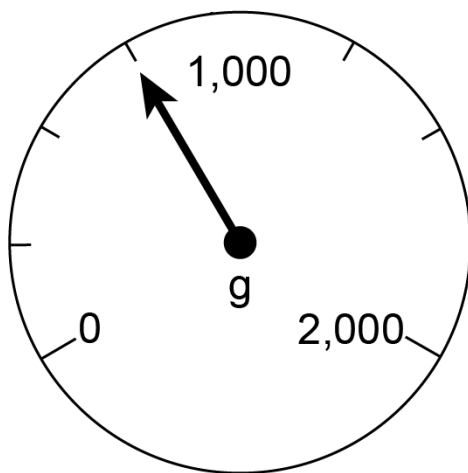

3. The beaker contains 1 litre of water.

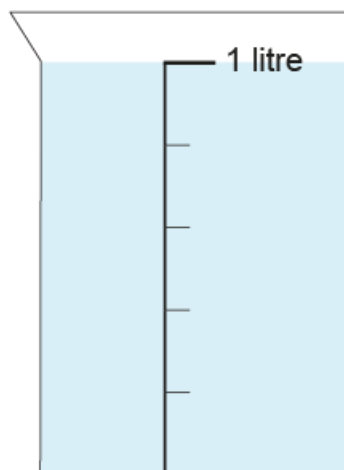

If I pour out 600ml, how much is left? Mark the new water level on the picture.

- A motorway repair team can build 250m of motorway barrier in 1 day. In 5 working days, how many metres of motorway barrier can they build?
- How many 500ml bottles can I fill from a 3 litre container of water?

6. The pictogram shows how many cans a class recycled in 2020.

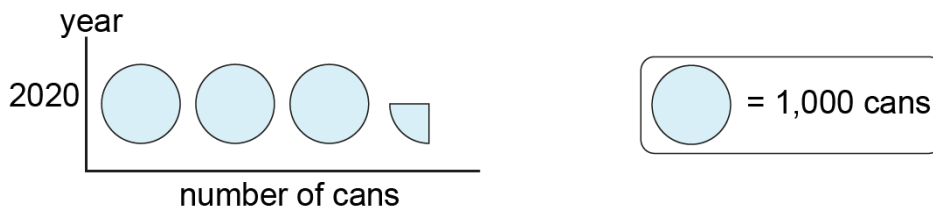

How many cans did the class recycle in 2020?

7. 1kg of strawberries is shared equally between 5 people. How many grams of strawberries do they each get?
8. I have already swum 750m. How much further do I need to go to swim 2km?
9. Fill in the missing parts, and write as many different equations as you can think of to describe the structure.

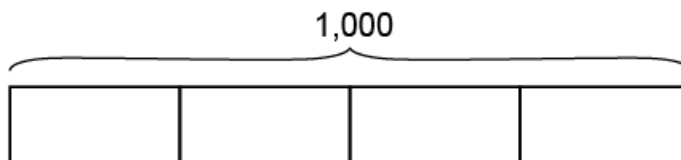

10. The bar charts show the number of red and blue cars that passed 3 different schools on a given day. How many red and blue cars passed each school?

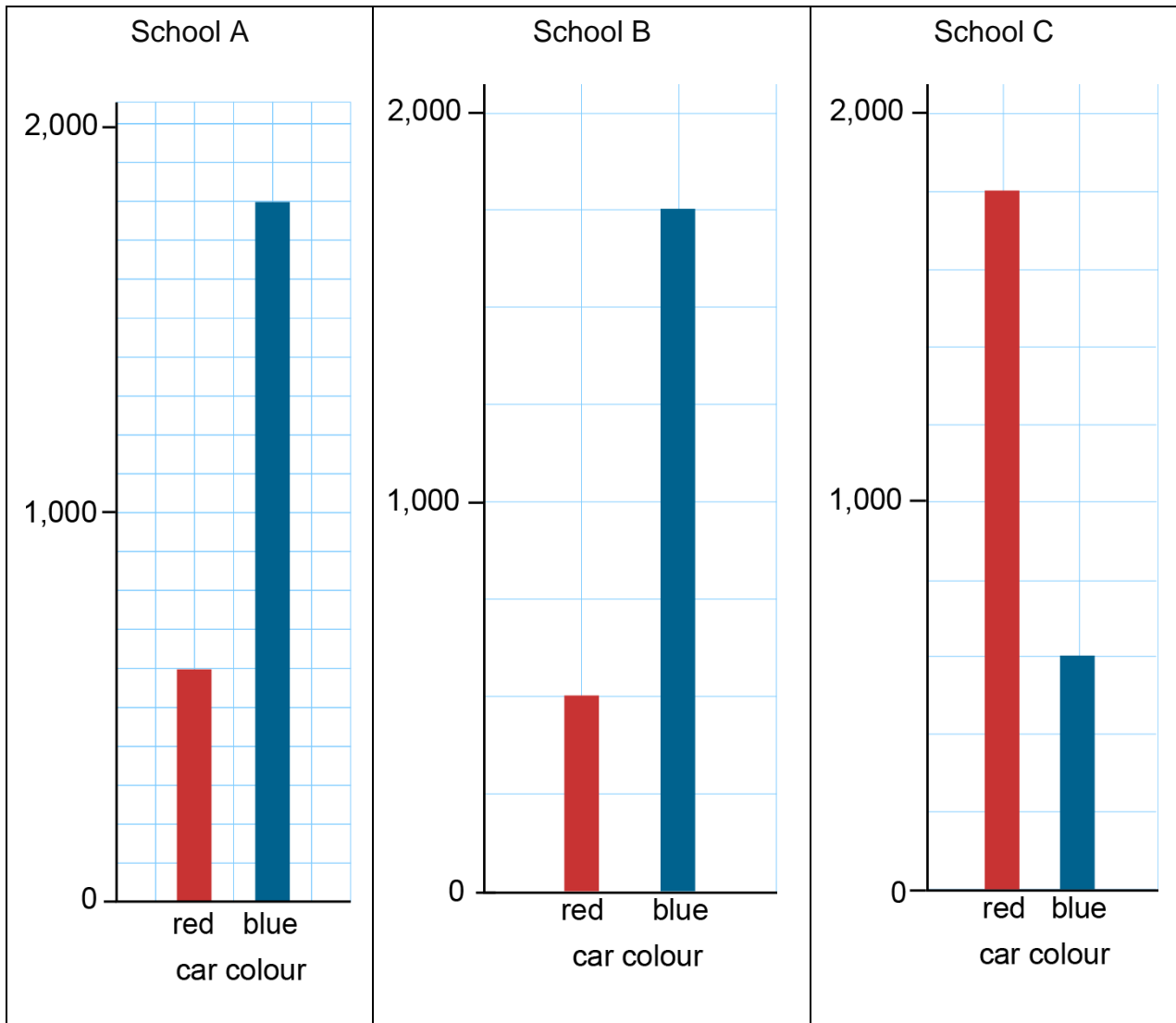

11. Fill in the missing numbers.

$1,000 \div 4 = \square$

$\square \times 200 = 1,000$

$1,000 \div 500 = \square$

$250 + \square = 1,000$

4NF–1 Recall of multiplication tables

Recall multiplication and division facts up to 12×12 , and recognise products in multiplication tables as multiples of the corresponding number.

4NF–1 Teaching guidance

The national curriculum requires pupils to recall multiplication table facts up to 12×12 , and this is assessed in the multiplication tables check. For pupils who do not have automatic recall of all of the facts by the time of the check, fluency in facts up to 9×9 should be prioritised in the remaining part of year 4. The facts to 9×9 are particularly important for progression to year 5, because they are required for formal written multiplication and division.

The 36 multiplication facts that are required for formal written multiplication are as follows.

2×2							
3×2	3×3						
4×2	4×3	4×4					
5×2	5×3	5×4	5×5				
6×2	6×3	6×4	6×5	6×6			
7×2	7×3	7×4	7×5	7×6	7×7		
8×2	8×3	8×4	8×5	8×6	8×7	8×8	
9×2	9×3	9×4	9×5	9×6	9×7	9×8	9×9

During application of formal written multiplication, pupils may also need to multiply a one-digit number by 1. Multiplication of the numbers 1 to 9 by 1 are not listed here because these calculations do not need to be recalled in the same way.

While pupils are learning the individual multiplication tables, they should also learn that:

- the factors can be written in either order and the product remains the same (for example, we can write $3 \times 4 = 12$ or $4 \times 3 = 12$ to represent the third fact in the 4 multiplication table)
- the products within each multiplication table are multiples of the corresponding number, and be able to recognise multiples (for example, pupils should recognise, 64 is a multiple of 8, but that 68 is not)
- adjacent multiples in, for example, the 8 multiplication table, have a difference of 8

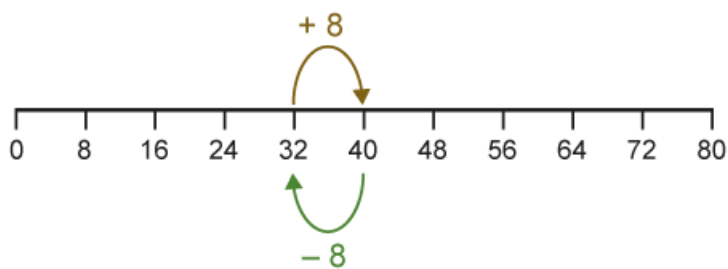

×	1	2	3	4	5	6	7	8
1	●	●	●	●	●	●	●	●
2	●	●	●	●	●	●	●	●
3	●	●	●	●	●	●	●	●
4	●	●	●	●	●	●	●	●
5	●	●	●	●	●	●	●	●

Figure 113: number line and array showing that adjacent multiples of 8 (32 and 40) have a difference of 8

Language focus

When pupils commit multiplication table facts to memory, they do so using a verbal sound pattern to associate the 3 relevant numbers, for example, “nine sevens are sixty-three”. It is important to provide opportunities for pupils to verbalise each multiplication fact as part of the process of developing fluency.

It is useful for pupils to learn the multiplication tables in the following order/groups:

1. 10 then 5 multiplication tables
2. 2, 4 and 8 multiplication tables one after the other
3. 3, 6, and 9 multiplication tables one after the other
4. 7 multiplication table
5. 11 and 12 multiplication tables

The connections and patterns will help pupils to develop fluency and understanding.

Pupils must also be able to apply their automatic recall of multiplication table facts to solve division problems, for example, solving $28 \div 7$, by recalling that $28 = 4 \times 7$.

You can find out more about developing automatic recall of multiplication tables here in the calculation and fluency section: [4NF-1](#)

Making connections

Solving division problems with remainders ([4NF-2](#)), relies on automatic recall of multiplication facts.

Criterion [4MD-2](#) involves linking individual multiplication facts to related multiplication and division facts. Once pupils have automatic recall of the multiplication table facts, they then have access to a whole set of related facts. For example, if pupils know that $3 \times 4 = 12$, they also know that $4 \times 3 = 12$, $12 \div 3 = 4$ and $12 \div 4 = 3$.

Converting mixed numbers to improper fractions ([4F-2](#)), also relies on automatic recall of multiplication facts. For example, converting $3\frac{1}{6}$ to an improper fraction involves calculating 3 times 6 sixths plus 1 more sixth, so requires knowledge of the multiplication fact $3 \times 6 = 18$.

Efficiently calculating the perimeter of a regular polygon ([4G-2](#)), or finding the side-length of a regular polygon, given the perimeter, depends on recall of multiplication and division facts.

4NF-1 Example assessment questions

1. A regular hexagon has sides of 7cm. What is its perimeter?

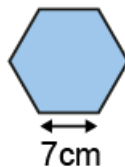

2. A regular octagon has a perimeter of 72cm. What is the length of each of the sides?

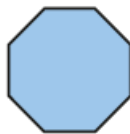

3. It takes Latoya 8 minutes to walk to school. It takes Tatsuo 3 times as long. How long does it take Tatsuo to walk to school?
4. An egg box contains 6 eggs. I need 54 eggs. How many boxes should I buy?
5. 8 children spend a day washing cars and earn £40 altogether. If they share the money equally how much do they each get?
6. Circle the numbers that are multiples of 3.

16 18 23 9 24

Assessment guidance: The multiplication tables check will assess pupils' fluency. Once pupils can automatically recall multiplication facts, they should be able to apply their knowledge to questions like those shown here.

4NF–2 Division problems with remainders

Solve division problems, with two-digit dividends and one-digit divisors, that involve remainders, for example:

$$74 \div 9 = 8 \text{ r } 2$$

and interpret remainders appropriately according to the context.

4NF–2 Teaching guidance

Pupils should recognise that a remainder arises when there is something 'left over' in a division calculation. Pupils should recognise and understand why remainders only occur when the dividend is not a multiple of the divisor. This can be achieved by discussing the patterns seen when the dividend is incrementally increased by 1 while the divisor is kept the same.

Total number of apples (dividend)	Number of apples in each tray (divisor)	Number of trays (quotient)	Number of apples left over (remainder)	Equation
12	4	3	0	$12 \div 4 = 3$
13	4	3	1	$13 \div 4 = 3 \text{ r } 1$
14	4	3	2	$14 \div 4 = 3 \text{ r } 2$
15	4	3	3	$15 \div 4 = 3 \text{ r } 3$
16	4	4	0	$16 \div 4 = 4$
17	4	4	1	$17 \div 4 = 4 \text{ r } 1$
18	4	4	2	$18 \div 4 = 4 \text{ r } 2$
19	4	4	3	$19 \div 4 = 4 \text{ r } 3$
20	4	5	0	$20 \div 4 = 5$

A common mistake made by pupils is not making the maximum number of groups possible, for example:

$$17 \div 4 = 3 \text{ r } 5 \quad (\text{incorrect})$$

The table above can be used to help pupils recognise and understand that the remainder is always smaller than the divisor. Note that when pupils use the short division algorithm in year 5, if they ‘carry over’ remainders that are larger than the divisor, the algorithm will not work.

Language focus

“If the dividend is a multiple of the divisor there is no remainder.”

“If the dividend is not a multiple of the divisor, there is a remainder.”

“The remainder is always less than the divisor.”

Once pupils can correctly perform division calculations that involve remainders, they need to recognise that, when solving contextual division problems, the answer to the division calculation must be interpreted carefully to determine how to make sense of the remainder. The answer to the calculation is not always the answer to the contextual problem.

Consider the following context: Four scouts can fit in each tent. How many tents will be needed for thirty scouts?

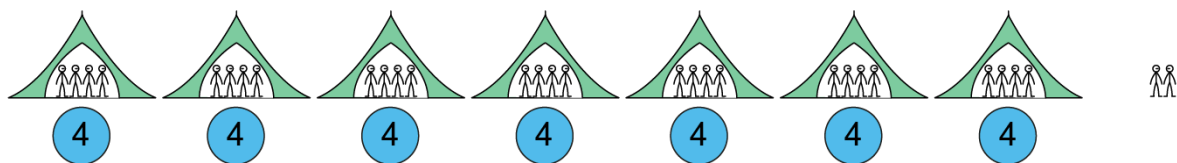

Figure 114: pictorial representation and counters: with 30 scouts and 4 per tent, 7 tents are insufficient

$$30 \div 4 = 7 \text{ r } 2$$

Pupils may simply say that “7 remainder 2 tents are needed”, but this does not answer the question. Pupils should identify what each number in the equation represents to help them correctly interpret the result of the calculation in context.

Language focus

“The 30 represents the total number of scouts.”

“The 4 represents the number of scouts in each tent.”

“The 7 represents the number of full tents.”

“The 2 represents the number of scouts left over.”

“We need another tent for the 2 left-over scouts. 8 tents are needed.”

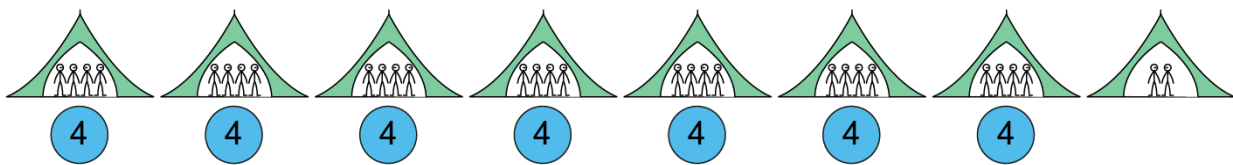

Figure 115: pictorial representation and counters: with 30 scouts and 4 per tent, 7 tents are insufficient

Making connections

Pupils must have automatic recall of multiplication facts and related division facts, and be able to recognise multiples ([4NF-1](#)) before they can solve division problems with remainders. For example, to calculate $55 \div 7$, pupils need to be able to identify the largest multiple of 7 that is less than 55 (in this case 49). They must then recall how many sevens there are in 49, and calculate the remainder.

Converting improper fractions to mixed numbers ([4F-2](#)) relies on solving division problems with remainders. For example, converting $\frac{19}{6}$ to a mixed number depends on the calculation $19 \div 6 = 3 \text{ r } 1$.

4NF-2 Example assessment questions

1. Which of these division calculations have the answer of 3 r 2?

$$23 \div 7$$

$$17 \div 5$$

$$32 \div 6$$

$$7 \div 2$$

$$14 \div 4$$

$$30 \div 8$$

2. I have 60 metres of bunting for the school fair. What length of bunting will be left over if I cut it into lengths of 8 metres?

3. It takes 7 minutes to make a pom-pom. How many complete pom-poms can Malik make in 30 minutes?
4. 23 apples are shared equally between 4 children. How many whole apples does each child get?
5. Ruby writes:
 $37 \div 5 = 6 \text{ r } 7$
 Explain what mistake Ruby has made, and write the correct answer.
6. Decide whether each calculation has a remainder or not. Explain how you can do this without doing each calculation?

	Has a remainder? (Yes or No)
$48 \div 7$	
$48 \div 8$	
$48 \div 9$	
$56 \div 7$	
$56 \div 8$	
$56 \div 9$	

4NF–3 Scaling number facts by 100

Apply place-value knowledge to known additive and multiplicative number facts (scaling facts by 100), for example:

$$8 + 6 = 14 \text{ and } 14 - 6 = 8$$

so

$$800 + 600 = 1,400 \text{ and } 1,400 - 600 = 800$$

$$3 \times 4 = 12 \text{ and } 12 \div 4 = 3$$

so

$$300 \times 4 = 1,200 \text{ and } 1,200 \div 4 = 300$$

4NF–3 Teaching guidance

Pupils should begin year 4 with automatic recall of addition and subtraction facts within 20 (**3NF–1**). By the end of year 4, pupils should be able to recall all multiplication table facts and related division facts. To be ready to progress to year 5, pupils must also be able to combine these facts with unitising in hundreds, including:

- scaling known additive facts within 10, for example, $900 - 600 = 300$
- scaling known additive facts that bridge 10, for example, $800 + 600 = 1,400$

- scaling known multiplication tables facts, for example, $300 \times 4 = 1,200$
- scaling division facts derived from multiplication tables, for example, $1,200 \div 4 = 300$

For calculations such as $800 + 600 = 1,400$, pupils can begin by using tens frames and counters as they did for calculation across 10 ([2AS-1](#)) and across 100 ([3NF-3](#)), but now using 100-value counters.

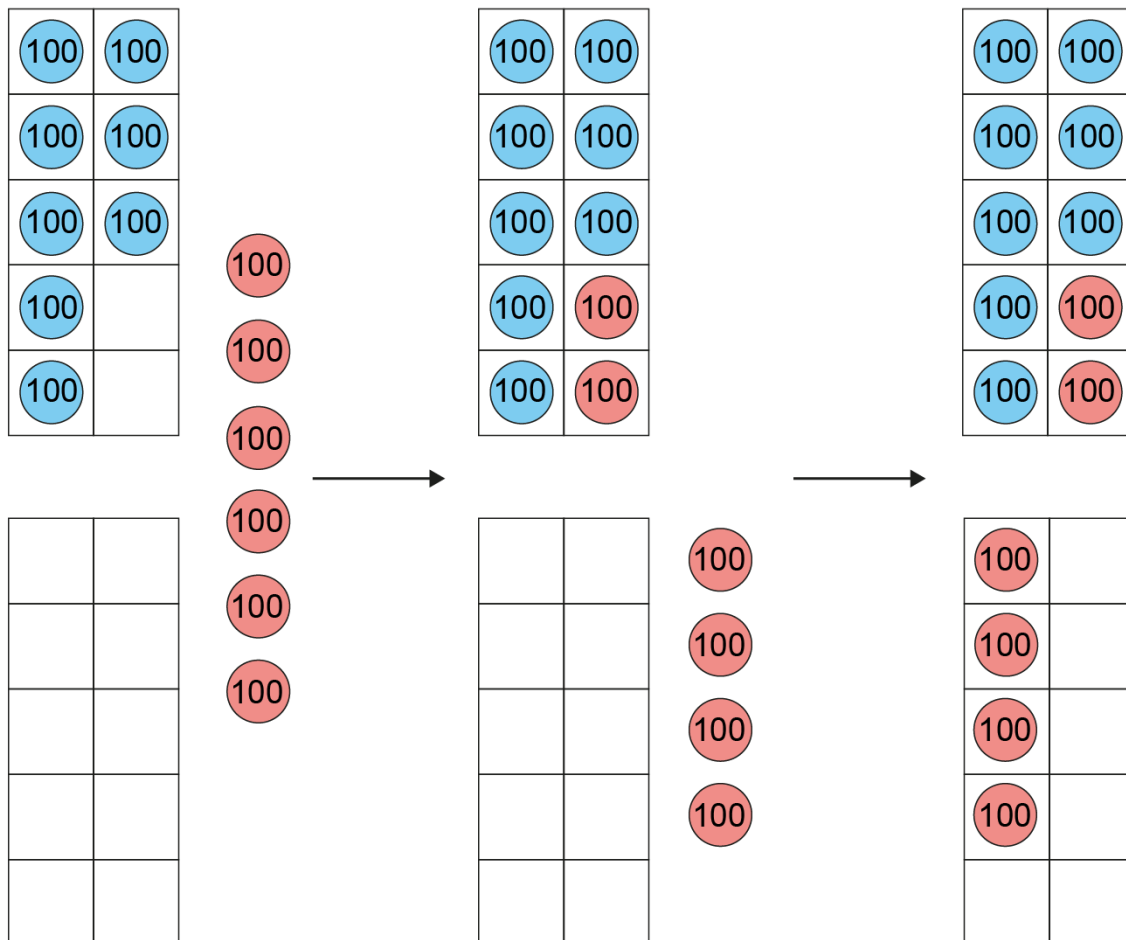

Figure 116: tens frames with 100-value counters showing $800 + 600 = 1,400$

$$8 + 6 = 14$$

$$800 + 600 = 1,400$$

$$14 - 6 = 8$$

$$1,400 - 600 = 800$$

$$14 - 8 = 6$$

$$1,400 - 800 = 600$$

Similarly, pupils can use 100-value counters to understand how a known multiplicative fact, such as $3 \times 5 = 15$, relates to a scaled calculation, such as $300 \times 5 = 1,500$. Pupils should be able reason in terms of unitising in hundreds, or in terms of scaling a factor by 100.



Figure 117: 3-by-5 array of 100-value place-value counters

$$3 \times 5 = 15$$
$$3 \times 500 = 1,500$$

$$3 \times 5 = 15$$
$$300 \times 5 = 1,500$$

Language focus

“3 times 5 is equal to 15.”

“3 times 5 hundreds is equal to 15 hundreds.”

“15 hundreds is equal to 1,500.”

Language focus

“3 times 5 is equal to 15.”

“3 hundreds times 5 is equal to 15 hundreds.”

“15 hundreds is equal to 1,500.”

Language focus

“If I multiply one factor by 100, I must multiply the product by 100.”

Pupils must be able to make similar connections for known division facts.

$$15 \div 3 = 5$$

$$1,500 \div 300 = 5$$

$$1,500 \div 3 = 500$$

Language focus

“If I multiply the dividend by 100 and the divisor by 100, the quotient remains the same.”

“If I multiply the dividend by 100 and keep the divisor the same, I must multiply the quotient by 100.”

It is important for pupils to understand all of the calculations in this criterion in terms of working with units of 100, or scaling by 100.

You can find out more about fluency and recording for these calculations here in the calculation and fluency section: [Number, place value and number facts: 4NPV-2 and 4NF-3](#)

Making connections

This criterion builds on pupils' additive fluency and also on:

- [4NPV-1](#) , where pupils need to be able to work out how many hundreds there are in any four-digit multiple of 100
- [4NF-1](#) , where pupils develop fluency in multiplication and division facts

Meeting this criterion also requires pupils to be able to fluently multiply whole numbers by 100 ([4MD-1](#)).

4NF-3 Example assessment questions

1. I need 1kg of flour to make some bread. I have 800g. How many more grams of flour do I need?
2. A builder can buy bricks in pallets of 600. How many pallets should she buy if she needs 1,800 bricks?
3. Dexter ran round a 400m running track 6 times. How far did he run?
4. I mix 700ml of orange juice and 600ml of lemonade to make a fruit drink for a party. What volume of fruit drink have I made in total?
5. A farmer had 1,200m of fencing to put up round his fields. He put up the same amount of fencing each day, and it took him 6 days to put up all the fencing. How many metres of fencing did he put up each day?
6. Fill in the missing numbers.

$$300 + \square = 1,100$$

$$4,200 \div 600 = \square$$

4MD–1 Multiplying and dividing by 10 and 100

Multiply and divide whole numbers by 10 and 100 (keeping to whole number quotients); understand this as equivalent to making a number 10 or 100 times the size.

4MD–1 Teaching guidance

As well as being able to calculate multiplication and division by 10 and 100, pupils need to start to think about multiplication as scaling, so that they can conceive of dividing by 10 and 100 when there are decimal answers in year 5 ([5NF–2](#)). If pupils only understand multiplying by 10 or 100 in terms of the repeated addition/grouping structure of multiplication (for example, 23×100 is 100 groups of 23), they will struggle to conceptualise $23 \div 100$. However, if pupils understand 23×100 as ‘23, made one-hundred times the size’, the inverse of this, $23 \div 100$, can be thought of as ‘23 made one-hundredth times the size’. To meet criteria **4MD–1**, pupils should be able to use and understand the language of 10 or 100 times the size, and understand division as the inverse action; in year 5, once pupils have learnt about tenths and hundredths they should apply the language to division by 10 and 100 (1 tenth or 1 hundredth times the size).

Language focus

“23, made 100 times the size, is 2,300.”

“23 multiplied by 100 is equal to 2,300.”

“First we had 23 ones. Now we have 23 hundreds.”

“1,450 is 10 times the size of 145.”

“1,450 divided by 10 is equal to 145.”

“First we had 145 tens. Now we have 145 ones.”

Pupils know that 1,000 is 10 times the size of 100 ([4NPV–1](#)), and that 100 is 10 times the size of 10 ([3NPV–1](#)). Pupils should now extend this ‘10 times the size’ relationship to other numbers, beginning with those with 1 significant figure. The Gattegno chart can be used to help pupils see, for example, that 80, made 10 times the size is 800: pupils can move their finger or a counter *up* from 80 to 800. They should connect this action to multiplication by 10, and be able to solve/write the corresponding multiplication calculation ($80 \times 10 = 800$). Similarly, because 80 is 10 times the size of 8, they can solve $80 \div 10 = 8$, moving their finger or a counter *down* from 80 to 8.

1,000	2,000	3,000	4,000	5,000	6,000	7,000	8,000	9,000
100	200	300	400	500	600	700	800	900
10	20	30	40	50	60	70	80	90
1	2	3	4	5	6	7	8	9

$80 \times 10 = 800$ $80 \div 10 = 8$

Figure 118: using the Gattegno chart to multiply and divide by 10

Pupils may also work with place-value charts.

1,000s	100s	10s	1s
			8
	8	0	0

$8 \times 100 = 800$ $800 \div 100 = 8$

Figure 119: using a place-value chart to multiply and divide by 100

Repeated association of the written form (for example, $\times 10$) and the verbal form (“ten times the size”) will help pupils become fluent with the links. Pupils should also be able to relate multiplying by 10 or by 100 with the idea of multiplying a quantity of items – here they can use the verbal form “ten times as many”, for example, “200 pencils is 10 times as many as 20 pencils.”

Both the Gattegno chart and the place-value chart also help pupils to see that multiplying by 100 is equivalent to multiplying by 10, and then multiplying by 10 again (and that dividing by 100 is equivalent to dividing by 10 and dividing by 10 again).

The same representations can be used to extend to numbers with more than one significant digit.

$$13 \times 10 = 130$$

$$130 \div 10 = 13$$

$$130 \times 10 = 1,300$$

$$1,300 \div 10 = 130$$

$$13 \times 100 = 1,300$$

$$1,300 \div 100 = 13$$

Making connections

In [3NPV-1](#) and [4NPV-1](#), respectively, children learnt that 100 is 10 times the size of 10, and 1,000 is 10 times the size of 100. Here they applied this idea to scaling other numbers.

Until [4MD-1](#), pupils understood, for example, 23×100 to represent 23 groups of 100. Here pupils must relate the same equation to a completely different structure – the scaling of 23 by 100 (making 23 one hundred times the size). Pupils learn more about how one equation can represent different multiplicative structures in [4MD-2](#).

4MD-1 Example assessment questions

1. Fill in the missing numbers.

$$\begin{array}{ccc} & \times 100 & \\ & \rightarrow & \\ \boxed{11} & & \boxed{} \\ & \leftarrow & \\ & \div 100 & \end{array}$$

$$\begin{array}{ccc} & \times 100 & \\ & \rightarrow & \\ \boxed{} & & \boxed{3,500} \\ & \leftarrow & \\ & \div 100 & \end{array}$$

$$\begin{array}{ccc} & \times 10 & \\ & \rightarrow & \\ \boxed{14} & & \boxed{} \\ & \leftarrow & \\ & \div 10 & \end{array}$$

$$\begin{array}{ccc} & \times 10 & \\ & \rightarrow & \\ \boxed{} & & \boxed{250} \\ & \leftarrow & \\ & \div 10 & \end{array}$$

2. Bethany has 15 marbles. Nasir has 100 times as many. How many marbles does Nasir have?
3. Sumaya's walk from her home to school is 130m. Millie's walk is 10 times as far. How far does Millie walk to get to school?
4. Fill in the missing numbers.

$$\boxed{} \times 100 = 600$$

$$1,500 = \boxed{} \times 10$$

$$\boxed{} \div 100 = 8$$

$$1,200 = \boxed{} \div 10$$

4MD–2 Manipulating the multiplicative relationship

Manipulate multiplication and division equations, and understand and apply the commutative property of multiplication.

4MD–2 Teaching guidance

Pupils will begin year 4 with an understanding of some of the individual concepts covered in this criterion, but they need to leave year 4 with a coherent understanding of multiplicative relationships, and how multiplication and division equations relate to the various multiplicative structures.

Pupils need to be able to apply the commutative property of multiplication in 2 different ways. The first can be summarised as ‘1 interpretation, 2 equations’. Here pupils must understand that 2 different equations can correspond to one context, for example, 2 groups of 3 is equal to 6 can be represented by $2 \times 3 = 6$ and by $3 \times 2 = 6$. Spoken language can support this understanding.

Language focus

“2 groups of 3 is equal to 6.”

“3, two times is equal to 6.”

“2 groups of 3 is equal to 3, two times.”

The second way that pupils must understand commutativity, can be summarised as ‘one equation, two interpretations’. Here, pupils must understand that a single equation, such as $2 \times 7 = 14$, can be interpreted in two ways.

Language focus

“2 groups of 7 is equal to 14.”

“7 groups of 2 is equal to 14.”

“2 groups of 7 is equal to 7 groups of 2.”

Pupils should understand that both interpretations correspond to the same total quantity (product).

Language focus

“factor times factor is equal to product”

“The order of the factors does not alter the product.”

An array is an effective way to illustrate this.

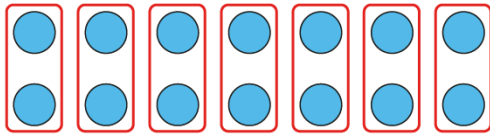

7 groups of 2

$$7 \times 2 = 14$$

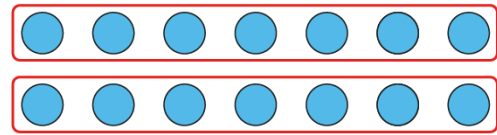

2 groups of 7

$$2 \times 7 = 14$$

$$7 \times 2 = 2 \times 7$$

Figure 120: using an array to show that 7 groups of 2 and 2 groups of 7 both correspond to the same total quantity

Pupils must be able to describe what each number in the equation represents for the 2 different interpretations, in context.

$$7 \times 2 = 14$$

$$2 \times 7 = 14$$

Interpretation 1

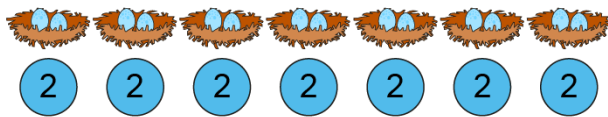

Figure 121: 7 groups of 2 – 7 nests of 2 eggs and seven 2-value counters

Interpretation 2

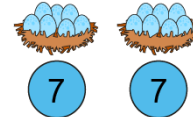

Figure 122: 2 groups of 7 – 2 nests of 7 eggs and two 7-value counters

Language focus

“The 2 represents number of eggs in each nest/group”.

“The 7 represents the number of nests/groups.”

“The 14 represents the total number of eggs/product.”

Language focus

“The 2 represents the number of nests/groups.”

“The 7 represents the number of eggs in each nest/group.”

“The 14 represents the total number of eggs/product.”

Pupils should be able to bring together these ideas to understand that either of a pair of multiplication equations can have two different interpretations.

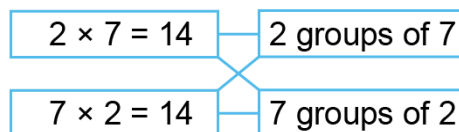

Figure 123: schematic diagram summarising the commutative property of multiplication and the different grouping interpretations

Pupils must understand that, because division is the inverse of multiplication, any multiplication equation can be rearranged to give division equations. The value of the product in the multiplication equation becomes the value of the dividend in the corresponding division equations.

$$2 \times 7 = 14$$

$$7 \times 2 = 14$$

$$14 \div 2 = 7$$

$$14 \div 7 = 2$$

This means that the commutative property of multiplication has a related property for division.

Language focus

“If we swap the values of the divisor and quotient, the dividend remains the same.”

As with multiplication, any division equation can be interpreted in two different ways, and these correspond to quotitive and partitive division.

$$14 \div 7 = 2$$

Partitive division

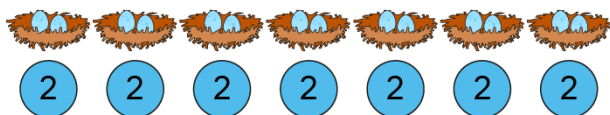

Figure 121: 7 groups of 2 – 7 nests of 2 eggs and seven 2-value counters

Quotitive division

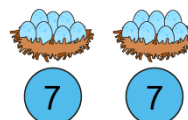

Figure 122: 2 groups of 7 – 2 nests of 7 eggs and two 7-value counters

Language focus

“14 shared between 7 is equal to 2.”

“The 14 represents the total number of eggs.”

“The 7 represents the number of nests/shares.”

“The 2 represents the number of eggs in each nest/share.”

Language focus

“14 divided into groups of 7 is equal to 2.”

“The 14 represents the total number of eggs.”

“The 7 represents the number of eggs in each nest/group.”

“The 2 represents the number of nests/groups.”

Pupils need to be able to fluently move between the different equations in a set, and understand how one known fact (such as $7 \times 2 = 14$) allows them to solve 4 different calculations each with two possible interpretations.

You can find out more about fluency in manipulating multiplication and division equations here in the calculation and fluency section: [4MD-2](#)

Making connections

Being able to move between the grouping and sharing structures of division supports calculation. For example, irrespective of the calculation context, pupils may find it more helpful to think of the sharing (partitive) structure when calculating $1,600 \div 2$ (1,600 shared or partitioned into 2 equal shares/parts is 800), rather than thinking about the grouping structure (800 twos in 1,600). Conversely, pupils may find it more helpful to think of $200 \div 25$ in terms of the grouping (quotitive) structure (how many groups of 25 there are in 200) rather than thinking about the sharing structure (200 shared or partitioned into 25 equal shares).

4MD–2 Example assessment questions

- Using pictures of vases of flowers, draw two pictures which can be represented by the equation $5 \times 4 = 20$.
- Write as many multiplication and division equations as you can to represent each picture.

a.

1,000			
250	250	250	250

b.



- Write a story that could be represented by this equation $3 \times 7 = 21$.
- Using pictures of apples in bowls, draw 2 pictures which can be represented by the equation $18 \div 3 = 6$.
- Use $15 \times 16 = 240$ to write 3 other related multiplication and division equations.
- 45kg of animal feed is shared between some horses. They each get 5kg. How many horses were there?
- 1m 40cm of ribbon was cut into equal pieces. Each piece is 14cm long. How many pieces of ribbon are there?
- Fill in the missing numbers.

$$\boxed{} \div 20 = 5$$

$$3,000 \div \boxed{} = 250$$

$$\boxed{} \times 100 = 5,400$$

4MD–3 The distributive property of multiplication

Understand and apply the distributive property of multiplication.

4MD–3 Teaching guidance

The first place that pupils will have encountered the distributive law is within the multiplication tables themselves. Pupils have seen, for example, that adjacent multiples in the 6 times table have a difference of 6. Number lines and arrays can be used to illustrate this.

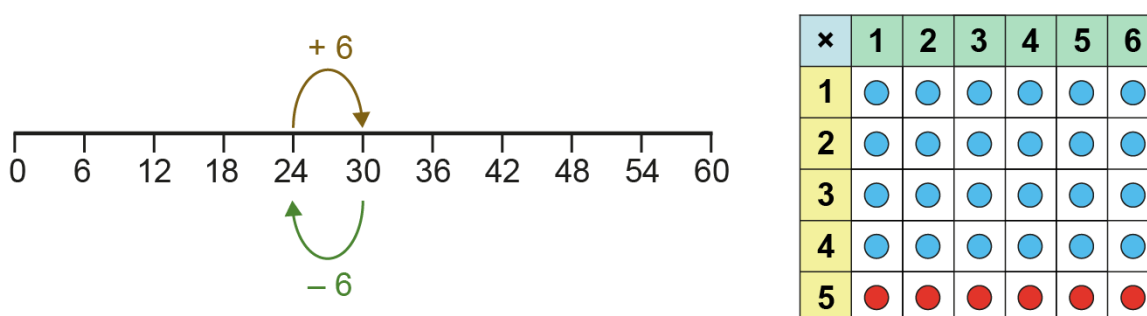

Figure 124: number line and array showing that adjacent multiples of 6 (24 and 30) have a difference of 6

Pupils should be able to represent such relationships using mixed operation equations, for example:

$$5 \times 6 = 4 \times 6 + 6 \quad \text{or} \quad 5 \times 6 = 4 \times 6 + 1 \times 6$$

$$4 \times 6 = 5 \times 6 - 6 \quad \text{or} \quad 4 \times 6 = 5 \times 6 - 1 \times 6$$

Pupils should learn that multiplication takes precedence over addition.

They should then extend this understanding beyond the multiplication tables, for example, if they are given the equation $20 \times 6 = 120$, they should be able to determine that $21 \times 6 = 126$, or vice versa.

Pupils also need to be able to apply the distributive property to non-adjacent multiples. The array chart used to show the connection between 4×6 and 5×6 can be adapted to show the connection between 5×6 , 3×6 and 2×6 .

×	1	2	3	4	5	6
1	●	●	●	●	●	●
2	●	●	●	●	●	●
3	●	●	●	●	●	●
4	●	●	●	●	●	●
5	●	●	●	●	●	●

Figure 125: Array showing the relationship between 5×6 , 3×6 and 2×6

As for adjacent multiples, pupils should be able to use mixed operation equations to represent the relationships:

$$5 \times 6 = 3 \times 6 + 2 \times 6$$

$$3 \times 6 = 5 \times 6 - 2 \times 6$$

$$2 \times 6 = 5 \times 6 - 3 \times 6$$

Again, pupils should understand that multiplication takes precedence: the multiplications are calculated first, and then the products are added or subtracted.

Pupils can use language patterns to support their reasoning.

Language focus

“5 is equal to 3 plus 2, so 5 times 6 is equal to 3 times 6 plus 2 times 6.”

This illustrates the distributive property of multiplication:

$$a \times (b + c) = a \times b + a \times c \quad \text{and} \quad a \times (b - c) = a \times b - a \times c$$

Note that the examples of adjacent multiples above are simply a special case of this in which b or c is equal to 1.

Pupils should then use the distributive property and known multiplication table facts to multiply 2-digit numbers (above 12) by one-digit numbers. 14×3 , for example, can be calculated by relating it to 10×3 and 4×3 :

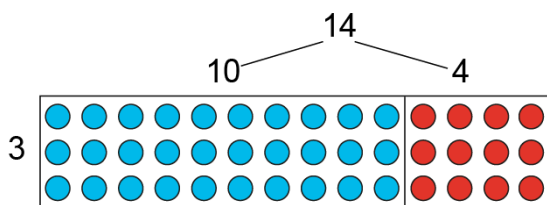

$$\begin{aligned}
 14 \times 3 &= 10 \times 3 + 4 \times 3 \\
 &= 30 + 12 \\
 &= 42
 \end{aligned}$$

Figure 126: array showing the relationship between 14×3 , 10×3 and 4×3

Pupils should recognise that factors can be partitioned in ways other than into ‘10 and a bit’. For example 14×3 could also be related to double 7×3 .

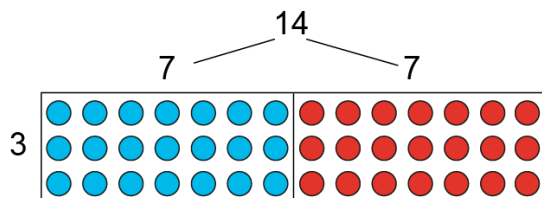

$$\begin{aligned}
 14 \times 3 &= 7 \times 3 + 7 \times 3 \\
 &= 21 + 21 \\
 &= 42
 \end{aligned}$$

Figure 127: array showing that 14×3 is double 7×3

Pupils should be expected to extend their understanding of the distributive law to support division. For example, they should be able to connect a calculation such as $65 \div 5$ to known multiplication and division facts: “we have 3 more fives than 10 fives” or “we have 1 more 5 than 12 fives”.

Making connections

Pupils need to be fluent in multiplication tables to 9×9 ([4NF-1](#)) and be able to multiply by 10 ([4MD-1](#)) to be able to efficiently apply the distributive property.

Mastery of this criterion supports fluency in the 11 and 12 multiplication tables, since multiplication by 11 or 12 can be derived from multiplication by 10 and by 1 or 2, using the distributive property. The formal written methods of multiplication also depend upon the distributive property of multiplication.

4MD–3 Example assessment questions

1. I had 6 flowers, each with 8 petals. If I get one more flower, how many petals do I have altogether?
2. Jordan buys 10 packs of soft drinks for a party. Each pack contains 6 cans. One pack is lemonade and the rest are cola. How many cans of cola are there?
3. I have a 65cm length of string. How many 5cm lengths can I make from it?
4. Fill in the missing symbols (<, > or =).

$$4 \times 6 \bigcirc 5 \times 6 - 6$$

$$4 \times 6 \bigcirc 3 \times 6 + 3$$

$$4 \times 6 \bigcirc 3 \times 6 + 6$$

$$4 \times 6 \bigcirc 6 \times 4$$

$$4 \times 6 \bigcirc 5 \times 6$$

$$6 \times 5 \bigcirc 4 \times 6$$

5. Fill in the missing numbers.

$$4 \times 7 = 3 \times 7 + \square$$

$$16 \times 4 = 10 \times 4 + \square \times 4$$

$$16 \times 4 = 8 \times 4 + \square \times 4$$

6. A box of chocolates costs £7. How much do 16 boxes cost?
7. Felicity is putting flowers into bunches of 5. So far she has made 4 bunches. She has 15 more flowers.
 - a. How many bunches will she make altogether?
 - b. How many flowers does she have altogether?
8. $3 \times 72 = 216$

Explain how you can use this fact to calculate:

- a. 3×73

- b. 4×72

4F–1 Mixed numbers in the linear number system

Reason about the location of mixed numbers in the linear number system.

4F–1 Teaching guidance

Sometimes pupils get quite far in their maths education only thinking of a fraction as a part of a whole, rather than as a number in its own right. In year 3, pupils learnt about the location in the linear number system of fractions between 0 and 1 ([3F–2](#)). For pupils to be able to add and subtract fractions across 1, or those greater than 1 ([4F–3](#)), they need to understand how mixed numbers fit into the linear number system.

Pupils should develop fluency counting in multiples of unit fractions, using number lines for support. Counting draws attention to the equivalence of, for example, $1\frac{4}{4}$ and 2, or $2\frac{5}{5}$ and 3. Pupils should practise counting both forwards and backwards.

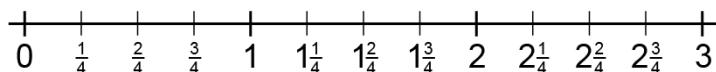

Figure 128: number line to support counting in multiples of one quarter

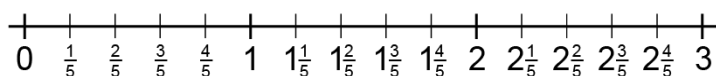

Figure 129: number line to support counting in multiples of one fifth

Pupils should then learn to label marked number lines, extending beyond 1. A common mistake that pupils make is to count the number of marks between labelled intervals, rather than the number of parts. For example, on the number line below they may count 3 marks and incorrectly deduce that the number line is marked in thirds.

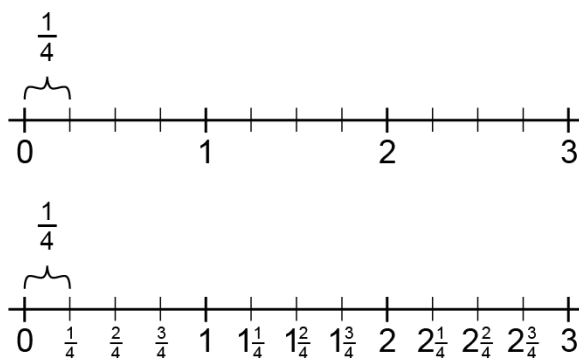

Figure 130: labelling a number line marked in quarters

Language focus

“Each interval is divided into 4 equal parts, so we count in quarters.”

Pupils should also be able to estimate the value or position of mixed numbers on number lines which do not have fractional marks. Pupils must understand that it is not the absolute size of the numerator and denominator which determine the value of the fractional part of the mixed number, but the *relationship* between the numerator and denominator (whether the numerator is a large or small part of the denominator). Pupils need to be able to reason, for example, that $1\frac{7}{8}$ is close to 2, but that $1\frac{7}{30}$ is closer to 1.

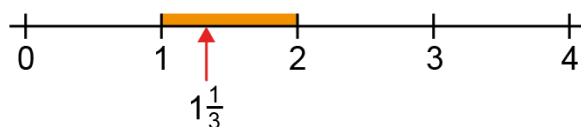

Figure 131: placing a mixed number on a number line with no fractional marks

Pupils must also be able to identify the previous and next whole number, and will then be able to round to the nearest whole number, which further supports estimation and approximation.

Language focus

“ $1\frac{1}{3}$ is between 1 and 2.”

“The previous whole number is 1.”

“The next whole number is 2.”

Making connections

Having a visual image of mixed numbers in the linear number system helps pupils to add and subtract fractions with the same denominator (including mixed numbers), for example $4\frac{2}{5} - \frac{3}{5}$ ([4F-3](#)). It also supports comparison of mixed numbers, and reading scales.

4F-1 Example assessment questions

1. Add labels to each mark on the number lines.

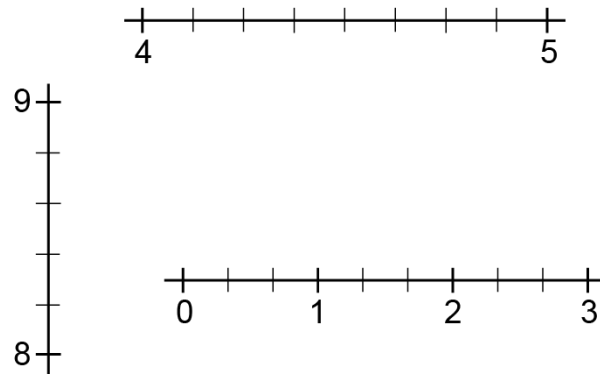

2. What are the values of a, b, c and d?

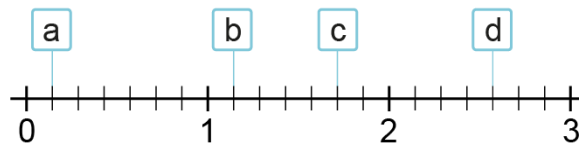

3. Estimate the position of the following numbers on the number line.

$$2\frac{2}{9} \qquad \frac{2}{3} \qquad 3\frac{3}{7} \qquad 1\frac{1}{5}$$

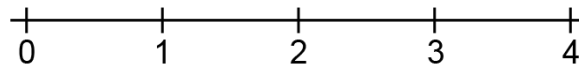

4. How much water is in the beaker? Write your answer as a mixed number.

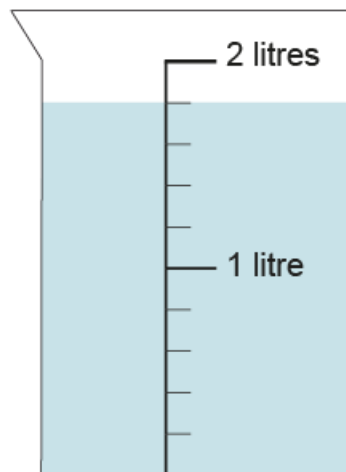

5. Circle the larger number in each of these pairs. Explain your reasoning.

$$3\frac{3}{9} \quad 3\frac{8}{9} \qquad 4\frac{1}{3} \quad 4\frac{1}{8} \qquad 2\frac{1}{3} \quad 1\frac{2}{3}$$

4F–2 Convert between mixed numbers and improper fractions

Convert mixed numbers to improper fractions and vice versa.

4F–2 Teaching guidance

It should be noted that this criterion covers content that is in year 5 of the national curriculum. It has been included here, in year 4, to improve coherence. Pupils have already learnt that fractions where the numerator is equal to the denominator have a value of 1. This knowledge should be extended to other integers. For example, if we know that $\frac{5}{5} = 1$, we can repeat groups of $\frac{5}{5}$ to see that $\frac{10}{5} = 2$ and $\frac{15}{5} = 3$ and so on.

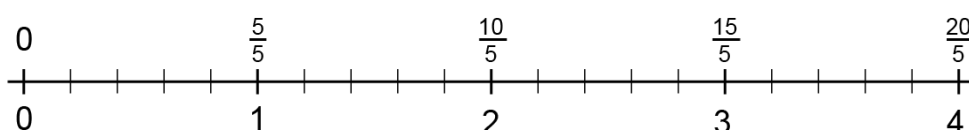

Figure 132: number line showing integers expressed as fractions

Language focus

“When the numerator is a multiple of the denominator, the fraction is equivalent to a whole number.”

Pupils can then learn to express mixed numbers as improper fractions.

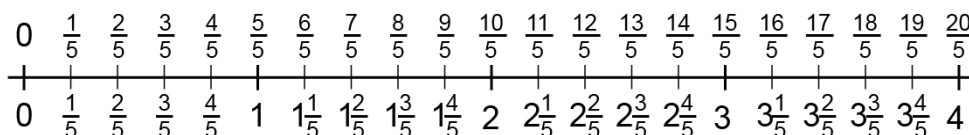

Figure 133: number line showing mixed number–improper fraction equivalence

To convert from mixed numbers to improper fractions, pupils should use their multiplication tables facts to find the improper-fraction equivalent to the integer part of the mixed number, and then add on the remaining fractional part.

1 m					1 m					$\frac{1}{5}m$	$\frac{1}{5}m$	$\frac{1}{5}m$
$\frac{1}{5}m$	$\frac{1}{5}m$	$\frac{1}{5}m$	$\frac{1}{5}m$	$\frac{1}{5}m$	$\frac{1}{5}m$	$\frac{1}{5}m$	$\frac{1}{5}m$	$\frac{1}{5}m$	$\frac{1}{5}m$	$\frac{1}{5}m$	$\frac{1}{5}m$	$\frac{1}{5}m$

$$2\frac{3}{5}m = \frac{13}{5}m$$

Figure 134: bar model showing mixed number–improper fraction equivalence

Language focus

“There are 2 groups of five-fifths, which is 10 fifths and 3 more fifths. This is 13 fifths.”

Pupils should then learn to convert in the other direction – from improper fractions to mixed numbers. Pupils need to understand the improper fraction in terms of a multiple of a unit fraction. For example, they should be able to see $\frac{21}{8}$ as 21 one-eighths. Pupils can initially use unit-fraction counters (here, $\frac{1}{8}$ value counters) to represent this. Conversion to a mixed number then builds on division with remainders (**4NF-2**). In this example, since 8 one-eighths is equal to 1 whole, pupils must find how many wholes can be made from the 21 eighths, and how many eighths are left over.

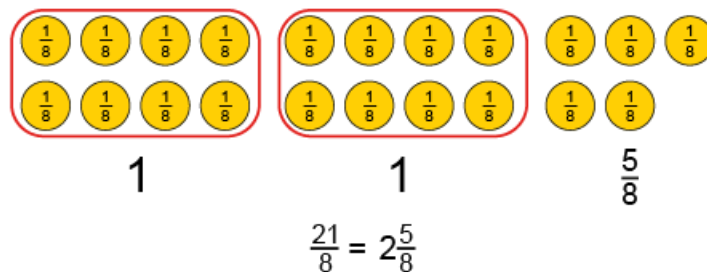

Figure 135: using unit fraction counters to support conversion from an improper fraction to a mixed number

Language focus

“We have 21 eighths. 8 eighths is equal to 1 (whole).”

“21 eighths is equal to 2 groups of 8 eighths, and 5 more eighths. This is 2 and 5 eighths.”

Once pupils have an understanding of the conversion process, they should not need to use counters or other similar manipulatives or drawings.

Making connections

For pupils to succeed with this criterion, they must first be fluent in multiplication facts (**4NF-1**) and division with remainders (**4NF-2**). Converting, for example, $3\frac{1}{6}$ to an improper fraction involves calculating $3 \times 6 + 1$ (**4NF-1**). The reverse process, (converting $\frac{19}{6}$ to a mixed number) involves calculating $19 \div 6 = 3 \text{ r } 1$ (**4NF-2**).

Converting between mixed numbers and improper fractions also supports efficient addition and subtraction of fractions with the same denominator (**4F-3**). Being able to move easily between the two will allow pupils to choose the most efficient calculation approach.

4F-2 Example assessment questions

1. Which of these fractions are equivalent to a whole number? Explain how you know.

$$\frac{48}{6} \quad \frac{48}{7} \quad \frac{48}{8} \quad \frac{48}{9} \quad \frac{48}{10}$$

2. Express the following mixed numbers as improper fractions.

$$4\frac{1}{8} \quad 6\frac{4}{9} \quad 3\frac{11}{12} \quad 8\frac{2}{3}$$

3. Express the following improper fractions as mixed numbers.

$$\frac{17}{2} \quad \frac{13}{6} \quad \frac{28}{10} \quad \frac{41}{7}$$

4. Sarah wants to convert $\frac{17}{4}$ to a mixed number. She writes:

$$\frac{17}{4} = 3\frac{5}{4}$$

Explain what mistake Sarah has made, and write the correct answer.

5. The school kitchen has 17 packs of butter. Each pack weighs $\frac{1}{4}$ kg. How many kilograms of butter do they have altogether? Express your answer as a mixed number.
6. I have a $6\frac{1}{2}$ m length of string. How many $\frac{1}{2}$ m lengths can I cut?

4F–3 Add and subtract improper and mixed fractions (same denominator)

Add and subtract improper and mixed fractions with the same denominator, including bridging whole numbers, for example:

$$\frac{7}{5} + \frac{4}{5} = \frac{11}{5}$$

$$3\frac{7}{8} - \frac{2}{8} = 3\frac{5}{8}$$

$$7\frac{2}{5} + \frac{4}{5} = 8\frac{1}{5}$$

$$8\frac{1}{5} - \frac{4}{5} = 7\frac{2}{5}$$

4F–3 Teaching guidance

To meet this criterion, pupils must be able to carry out the following types of calculation (with a common denominator):

- add and subtract 2 improper fractions
- add and subtract a proper fraction to/from a mixed number
- add and subtract one mixed number to/from another

In year 3, pupils used their understanding that a non-unit fraction is a multiple of a unit fraction, for example, $\frac{2}{5}$ is 2 lots of $\frac{1}{5}$. This allowed them to reason that $\frac{2}{5} + \frac{2}{5} = \frac{4}{5}$, because 2 lots of $\frac{1}{5}$ plus 2 lots of $\frac{1}{5}$ is equal to 4 lots of $\frac{1}{5}$, or $\frac{4}{5}$.

Pupils should now apply this strategy to addition and subtraction involving improper fractions.

Language focus

“7 one-fifths plus 4 one-fifths is equal to 11 one-fifths.”

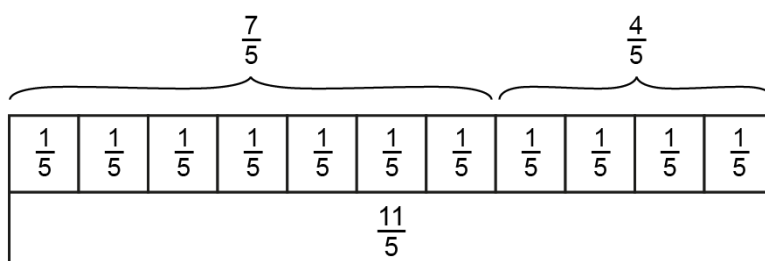

$$\frac{7}{5} + \frac{4}{5} = \frac{11}{5}$$

Figure 136: bar model showing addition of improper fractions with the same denominator

The generalisation that pupils learnt for adding and subtracting fractions with the same denominator within 1 whole therefore also extends to improper fractions.

Language focus

“When adding fractions with the same denominators, just add the numerators.”

“When subtracting fractions with the same denominators, just subtract the numerators.”

When adding and subtracting mixed numbers, pupils can convert them to improper fractions and apply this generalisation. This is sometimes a good approach. However this isn't always necessary, or the most efficient choice, and pupils should learn to use their knowledge of the composition of mixed numbers to add and subtract.

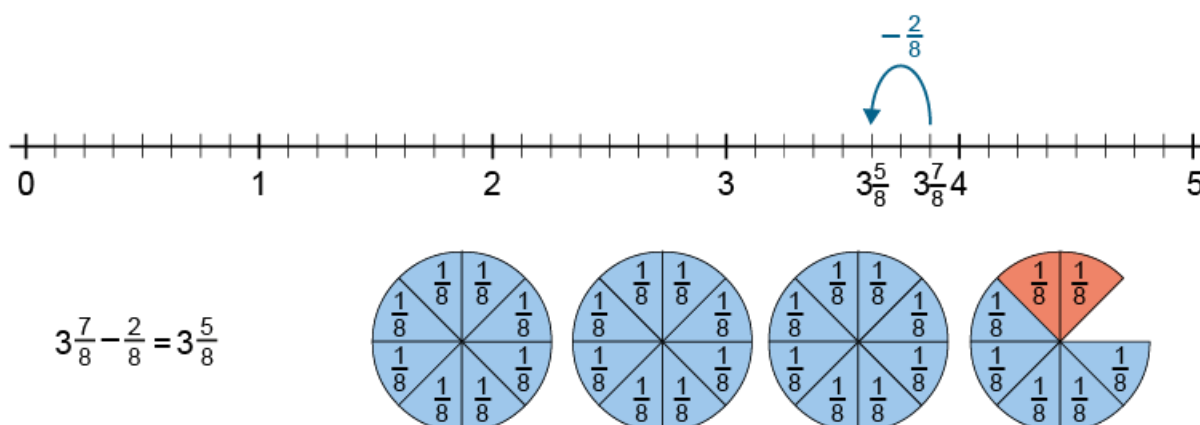

Figure 137: number line and pie model showing subtraction of a fraction from a mixed number (same denominator)

Pupils must also be able to add and subtract across a whole number, for example:

$$7\frac{2}{5} + \frac{4}{5} = 8\frac{1}{5}$$

$$8\frac{1}{5} - \frac{4}{5} = 7\frac{2}{5}$$

Addition strategies include:

- adding to reach the whole number, then adding the remaining fraction

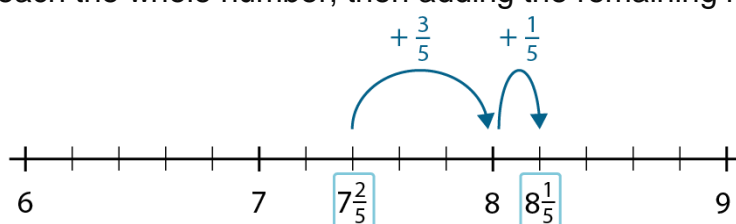

Figure 138: number line showing strategy for adding across a whole number

- adding the fractional parts first to give an improper fraction, which is then converted to a mixed number and added

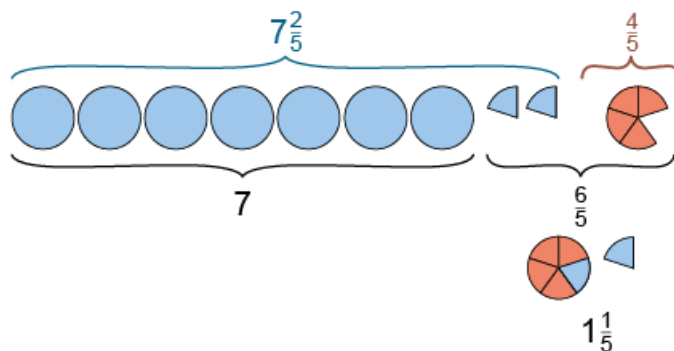

Figure 139: pie model showing strategy for adding across a whole number

Before pupils attempt to subtract across a whole number (for example, $8\frac{1}{5} - \frac{4}{5}$), they should first learn to subtract a proper fraction from a whole number (for example, $8 - \frac{3}{5}$). Pupils can find this challenging, so number lines and bar or pie models can be useful.

Once pupils can do this, they should be able to subtract across the whole number by using:

- a ‘subtracting through the whole number’ strategy (partitioning the subtrahend) – part of the subtrahend is subtracted to reach the whole number, then the rest of the subtrahend is subtracted from the whole number

or

- a ‘subtracting from the whole number’ strategy (partitioning the minuend) – the subtrahend is subtracted from the whole number part of the minuend, then the remaining fractional part of the minuend is added

Subtracting through the whole number

Subtracting from the whole number

$$\begin{aligned} 8\frac{1}{5} - \frac{4}{5} &= 8\frac{1-4}{5} \\ &= 8 - \frac{3}{5} \\ &= 7\frac{2}{5} \end{aligned}$$

$$\begin{aligned} 8\frac{1}{5} - \frac{4}{5} &= 8 - \frac{4}{5} + \frac{1}{5} \\ &= 7\frac{1}{5} + \frac{1}{5} \\ &= 7\frac{2}{5} \end{aligned}$$

Finally, pupils need to be able add one mixed number to another, and subtract one mixed number from another.

$$4\frac{2}{9} + 1\frac{3}{9} = 5\frac{5}{9}$$

$$5\frac{5}{9} - 1\frac{3}{9} = 4\frac{2}{9}$$

Pupils should initially solve problems where addition or subtraction of the fractional parts does *not* bridge a whole number. Both pie models, as above, and partitioning diagrams

can be used to support addition, by partitioning both of the mixed numbers into their whole number and fractional parts.

Pupils should not extend the method for addition – partitioning *both* mixed fractions – to subtraction of one mixed number from another. Pupils should instead use a similar strategy to that used for subtraction of one two-digit number from another ([2AS-2](#)), only partitioning the subtrahend.

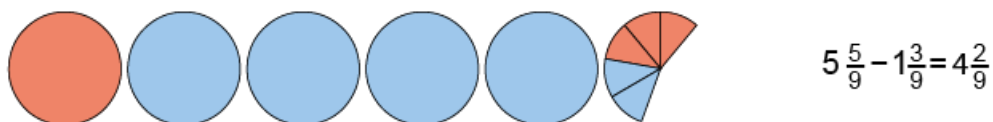

Figure 140: pie model showing strategy for subtracting across a whole number

This is important when subtraction of the fractional parts bridges a whole number, to avoid pupils writing a calculation that involves negative fractions.

Making connections

In [4F-2](#), pupils learnt to convert between improper fractions and mixed numbers. One strategy for adding and subtracting mixed numbers is to convert them to improper fractions before adding/subtracting and then to convert the answer back again. Pupils also need to draw on these conversions when addition of mixed numbers results in an improper fraction. For example, pupils should be expected to convert an answer such as $2\frac{9}{7}$ to $3\frac{2}{7}$.

In [4F-1](#), pupils learnt to position mixed numbers on a number line. This supports bridging through a whole number, for example understanding that $8\frac{1}{5} - \frac{4}{5} = 7\frac{2}{5}$.

Some of the strategies covered in this criterion are analogous to those that pupils have used for whole numbers. The 2 strategies presented for adding and subtracting across a whole number mirror those for adding and subtracting across 10, which pupils learnt in year 2 ([2NF-1](#)). The strategies presented for adding and subtracting two mixed numbers mirror those for adding and subtracting 2 two-digit numbers ([2AS-2](#)) – for addition, partition both addends; and for subtraction, partition only the subtrahend. If pupils can see these connections, they will be able to calculate more confidently with fractions, seeing them as just another type of number.

4F–3 Example assessment questions

1. It is a $2\frac{3}{4}$ km cycle ride to my friend's house, and a further $\frac{3}{4}$ km ride to the park. How far do I have to cycle altogether?
2. I have 5m of rope. I cut off $\frac{4}{10}$ m. How much rope is left?
3. Fill in the missing numbers.

$2\frac{1}{7}$	$2\frac{4}{7}$			$3\frac{6}{7}$	
----------------	----------------	--	--	----------------	--

4. The table below shows the number of hours Josie read each day during a school week. For how long did Josie read altogether?

Mon	Tues	Wed	Thurs	Fri
$1\frac{3}{4}$ hours	1 hour	$1\frac{1}{4}$ hours	$1\frac{1}{4}$ hours	$2\frac{3}{4}$ hours

5. A tailor has $3\frac{7}{10}$ m of ribbon. She uses $1\frac{9}{10}$ m to complete a dress. How much ribbon is left?

4G–1 Draw polygons specified by coordinates or by translation

Draw polygons, specified by coordinates in the first quadrant, and translate within the first quadrant.

4G–1 Teaching guidance

Pupils should already be adept at placing markings at specific points, and joining these accurately with a ruler to draw a polygon ([3G–1](#)).

Pupils can begin by describing translations of polygons drawn on squared paper, by counting how many units to the left/right and up/down the polygon has been translated.

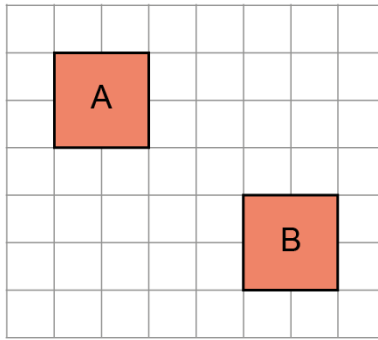

Figure 141: translation of a polygon on a square grid

Language focus

“The polygon has been translated 4 squares to the right and 3 squares down.”

Pupils should then learn to translate polygons on squared paper according to instructions that describe how many units to move the polygon to the left/right and up/down. Pupils can translate each point of the polygon individually, for example, translating each point right 4 and down 3 to mark the new points, and then joining them. Alternatively, pupils can translate and mark one point, then mark the other points of the polygon relative to the translated point.

In year 4, pupils must start to use coordinate geometry, beginning with the first quadrant. Initially, pupils can work with axes with no number labels, marking specified points as a translation from the origin, described as above.

For example, “Start at the origin and mark a point along 5, and up 4.”

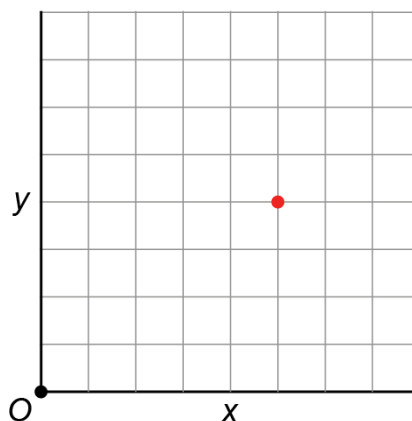

Figure 142: marking a point relative to the origin (O) on a grid with no number labels

Finally, pupils should learn to use coordinate notation with number labels on the axes. They must be able to mark the position of points specified by coordinates, and write coordinates for already marked points.

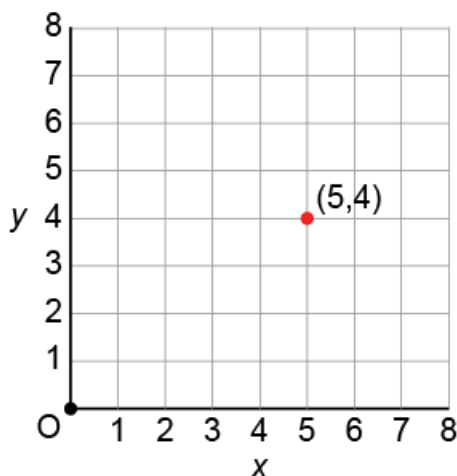

Figure 143: marking a point on a grid with number labels

When pupils first start to mark points, they should still start at the origin, moving along and then up as specified by the coordinates. If they do not do this, they are likely to place a point such as (5, 4) by just looking for a 5 and a 4, and possibly end up placing the point at (4, 5).

Language focus

“First count along the x-axis, then count along the y-axis.”

Pupils should then be able to draw polygons by marking and joining specified coordinates.

Making connections

In [4NPV-3](#) , [4NPV-4](#) and [4F-1](#), and in previous year groups, pupils learnt to place or identify specified points (numbers) on a number line or scale. In this criterion children learn to place or identify specified points with reference to 2 number lines.

4G–1 Example assessment questions

1. Translate the quadrilateral so that point A moves to point B.

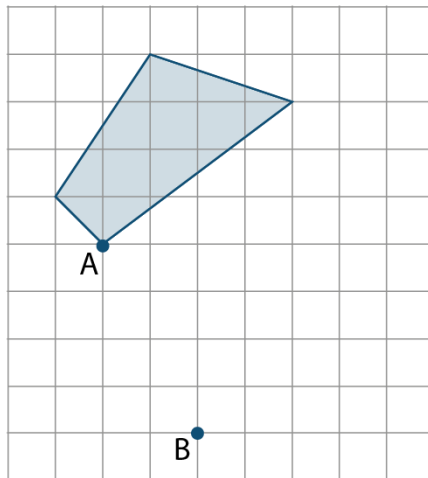

2. A kite has been translated from position A to position B. Describe the translation.

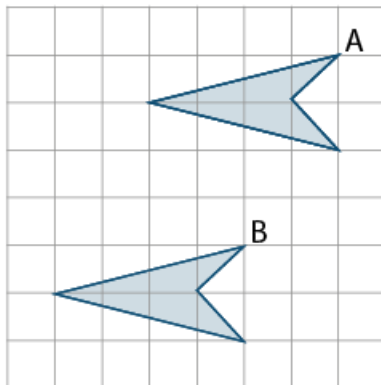

3. Mark the points, and join them to make a square.

(3,1) (2,4) (5,5) (6,2)

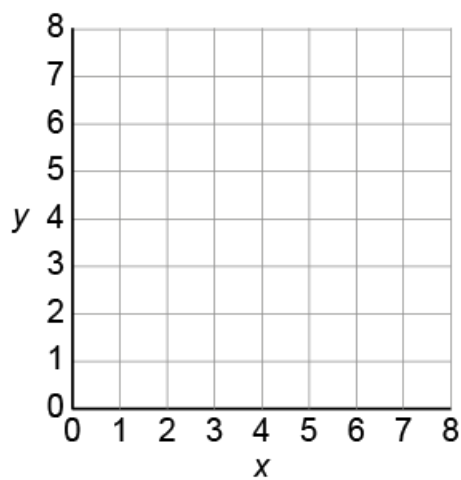

4. This triangle is translated so that point A moves to (4, 3). Draw the shape in its new position.

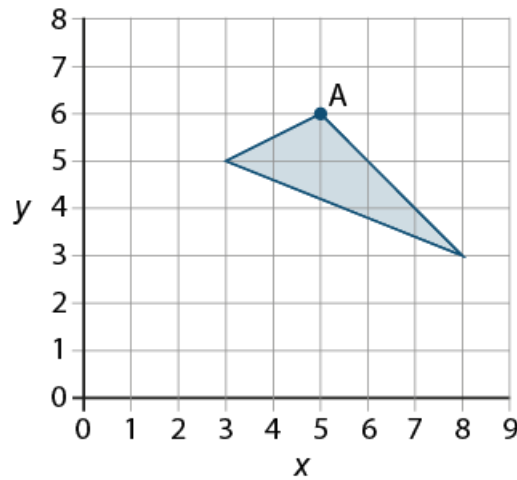

5. Mark the following points, and join them to make a polygon.

(5, 0) (3, 1) (5, 2) (7, 1)

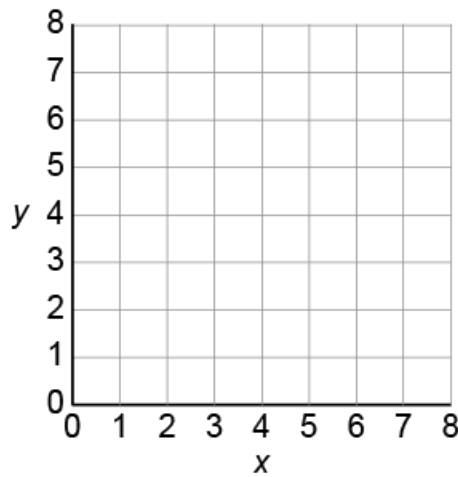

- a. What is the name of the polygon that you have drawn?
b. Translate the polygon you have just drawn left 2 and up 3. What are the coordinates of the vertices of this new polygon?

4G–2 Perimeter: regular and irregular polygons

Identify regular polygons, including equilateral triangles and squares, as those in which the side-lengths are equal and the angles are equal. Find the perimeter of regular and irregular polygons.

4G–2 Teaching guidance

Pupils must be able to identify regular polygons, and reason why a given polygon is regular.

Language focus

“This is a regular polygon, because all of the sides are the same length, and all of the interior angles are equal.”

Pupils often define a regular polygon as having equal side-lengths and neglect to mention the angles – it is important that pupils consider both sides and angles when assessing and describing whether a polygon is regular. Pupils should examine and discuss a wide range of irregular shapes, including examples with equal angles, but unequal side-lengths (shape **d** below), examples with equal angles, but unequal interior angles and unequal side-lengths (shape **c** below), and examples with equal side-lengths, but unequal angles (shape **e** below).

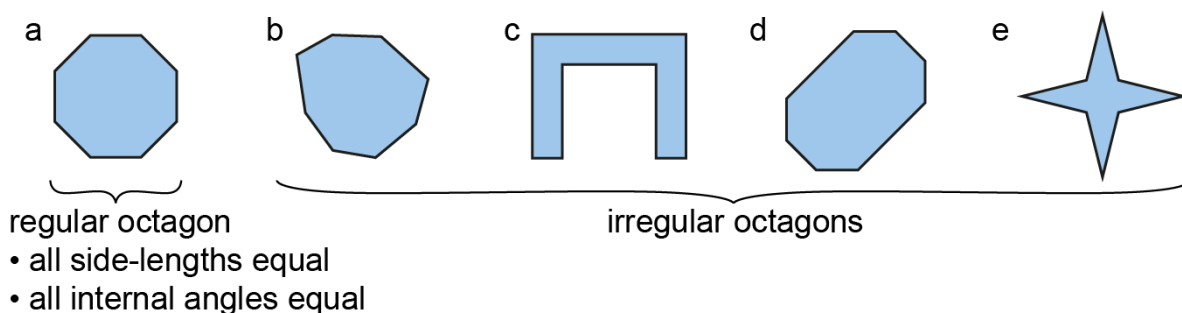
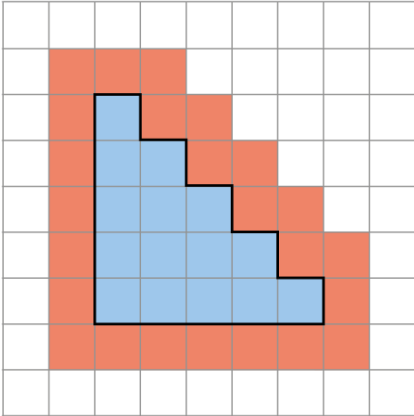
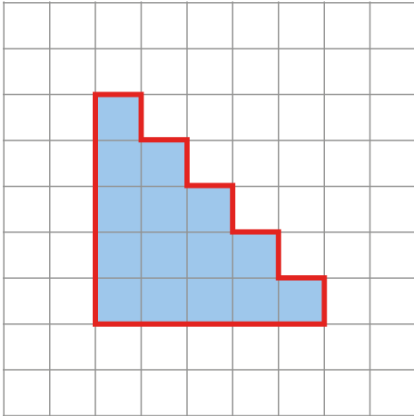



Figure 144: a regular octagon and 4 irregular octagons

Pupils can make different polygons with equal length geo-strips to explore regular shapes and irregular shapes with equal side-lengths but unequal angles. Pupils should compare angles using informal language, and begin to discuss whether angles are smaller than a right angle (acute), larger than a right angle but smaller than a ‘straight line’ (180°) (obtuse), or larger than a ‘straight line’ (180°) (reflex) in preparation for measuring angles with a protractor in year 5.

Pupils should also learn that equilateral triangles are regular triangles, and that squares are regular quadrilaterals.

Pupils need to understand perimeter as the total distance around the outside of a shape, and be able to measure or calculate the perimeter of shapes with straight sides. Pupils should be able to measure side-lengths in centimetres or metres, as appropriate, using skills developed from year 1 onwards. They should use an appropriate strategy to find the perimeter of a given polygon, according to the property of the shape.

Shape type	Strategy for calculating the perimeter
rectilinear shapes on centimetre-square-grids	<p>count the number of centimetre lines around the shape</p> <div style="display: flex; justify-content: space-around; align-items: flex-start;"> <div style="text-align: center;"> <p>incorrect</p>  <p>perimeter = 24cm</p> </div> <div style="text-align: center;"> <p>correct</p>  <p>perimeter = 20cm</p> </div> </div> <div style="text-align: right; margin-top: 10px;"> <p>1cm 1cm </p> </div> <p style="text-align: center;">Figure 145: incorrect and correct methods for finding the perimeter of a rectilinear shape on a square grid</p> <p style="text-align: right;"><i>Drawn to scale.</i></p>
polygons with equal side-lengths	<p>use multiplication:</p> <p>perimeter = side-length × number of sides</p>
polygons with unequal side-lengths	<p>use addition:</p> <p>perimeter = sum of the side-lengths</p>

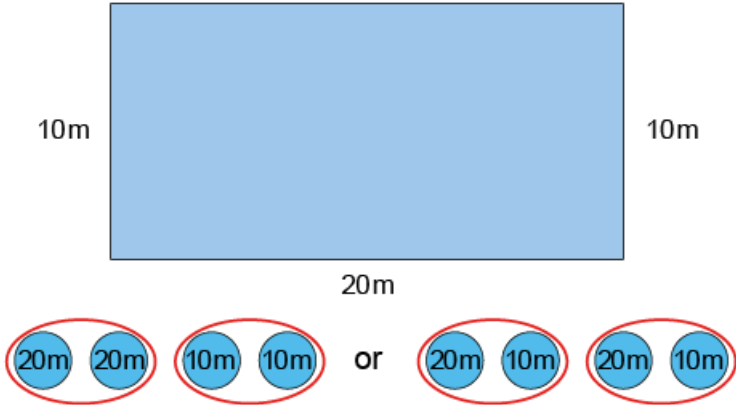
Shape type	Strategy for calculating the perimeter
rectangles	<p>use doubling and addition:</p> $\text{perimeter} = 2 \times (\text{length} + \text{width})$ <p>or</p> $\text{perimeter} = (2 \times \text{length}) + (2 \times \text{width})$  <p>Figure 146: 2 strategies for calculating the perimeter of a rectangle <i>Drawn to scale.</i></p>

As well as working with 'small' shapes in the classroom, pupils should gain experience working with larger shapes, such as calculating the perimeter of a rectilinear area drawn on the playground in metres.

Making connections

Pupils must be fluent in multiplication table facts ([4NF-1](#)) to efficiently calculate the perimeter of polygons with equal side-lengths. They must also be able to apply appropriate strategies for adding more than 2 numbers to calculate the perimeter of irregular polygons.

4G–2 Example assessment questions

1. Taro uses some 8cm sticks to make these shapes. Name each shape and find its perimeter.

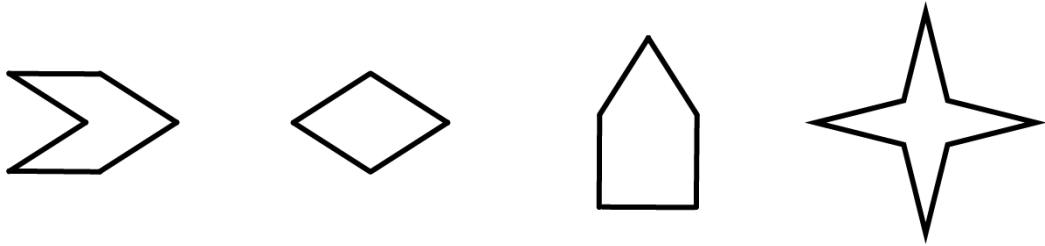

Drawn to scale.

2. What is the perimeter of this shape?

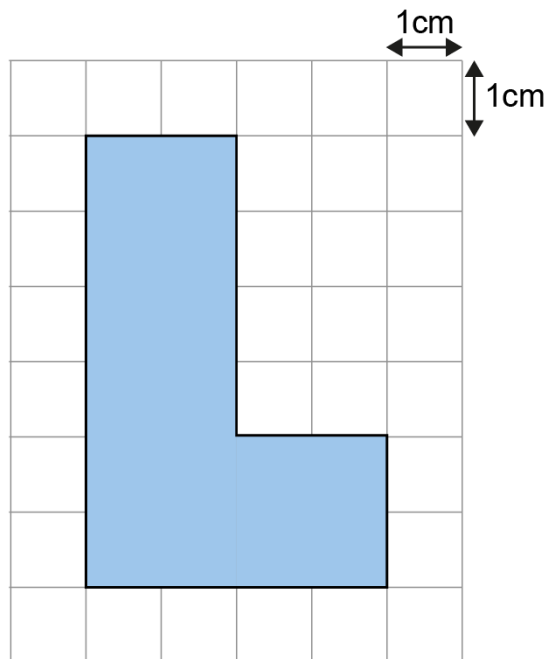

Drawn to actual size.

3. Sarah draws a rhombus with a perimeter of 36cm. What is the length of each side?
4. Here is a plan of a school playground. How many metres of fencing is needed to put a fence around the perimeter?

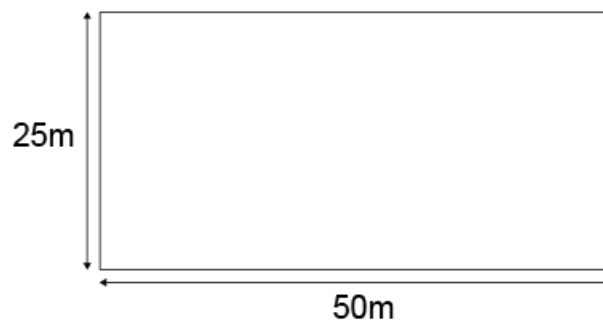

Drawn to scale.

5. Name each shape and say whether it is regular or irregular. Explain your reasons.

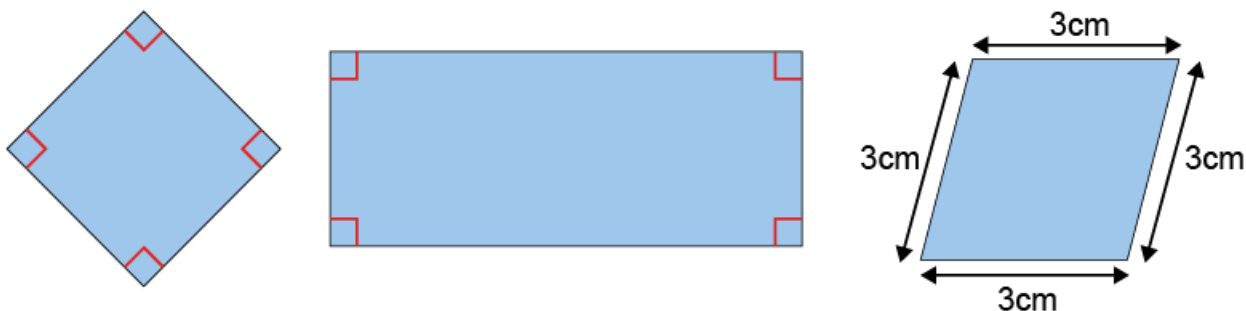

4G–3 Identify line symmetry in 2D shapes

Identify line symmetry in 2D shapes presented in different orientations. Reflect shapes in a line of symmetry and complete a symmetric figure or pattern with respect to a specified line of symmetry.

4G–3 Teaching guidance

Identifying line symmetry requires pupils to be able to decompose shapes: where line symmetry exists within a shape, the shape can be split into two parts which are a reflection of one another. Pupils should learn to compose a symmetrical shape from two congruent shapes.

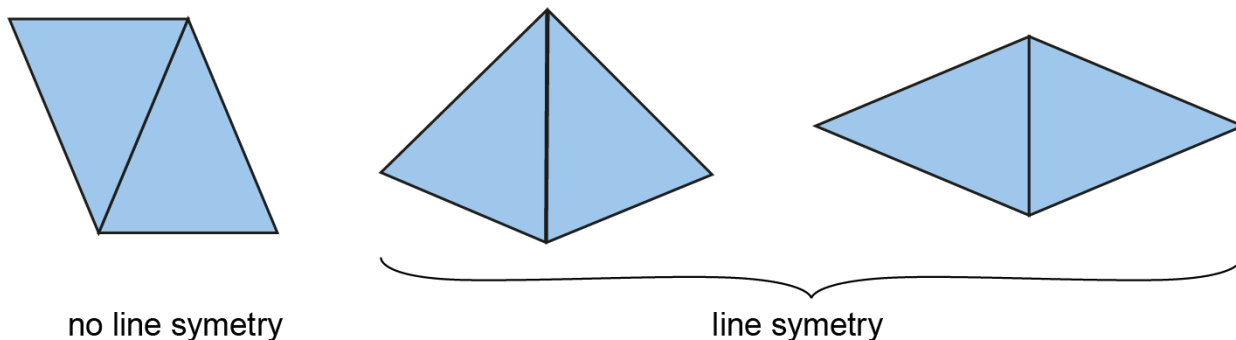

Figure 147: composing shapes from two identical isosceles triangles

Pupils should then learn to identify line symmetry in given symmetrical shapes. They can begin by folding or cutting paper shapes, or using a mirror, but should eventually be able to do this by mapping corresponding points in relation to the proposed line of symmetry. They should be able to explain why a particular shape is symmetrical, or why a given line is a line of symmetry.

Language focus

“This is a line of symmetry because it splits the shape into two equal parts which are mirror images.”

Pupils need to be able to identify line symmetry regardless of the orientation a shape is presented in, including cases where the line of symmetry is neither a horizontal nor a vertical line.

For the second part of this criterion, pupils must be able to reflect shapes in a line of symmetry, both where the line dissects the original shape (see [4G–3 Example assessment questions](#)) and where it does not, and complete symmetrical patterns.

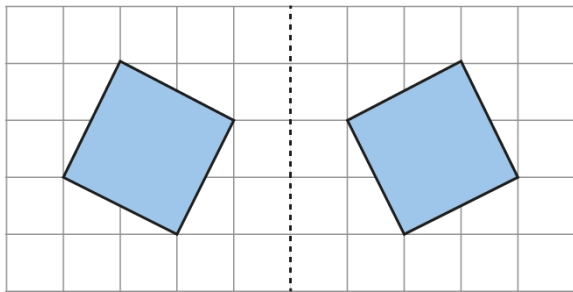

Figure 148: reflecting a shape in a line of symmetry

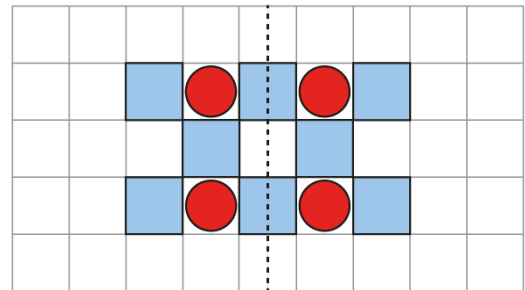
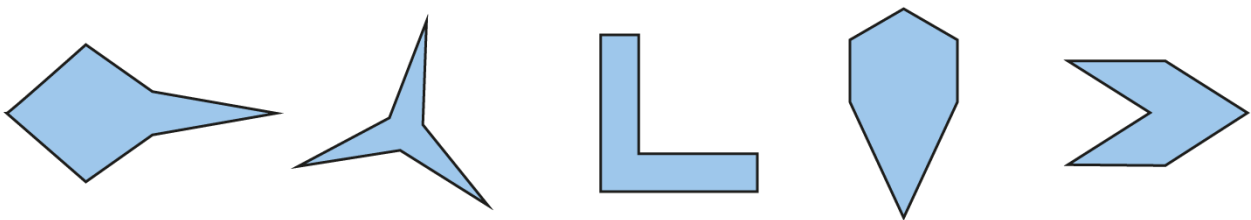

Figure 149: a symmetrical pattern

4G–3 Example assessment questions

1. Draw one or more lines of reflection symmetry in each of these irregular hexagons.



2. Reflect the three shapes in the mirror line.

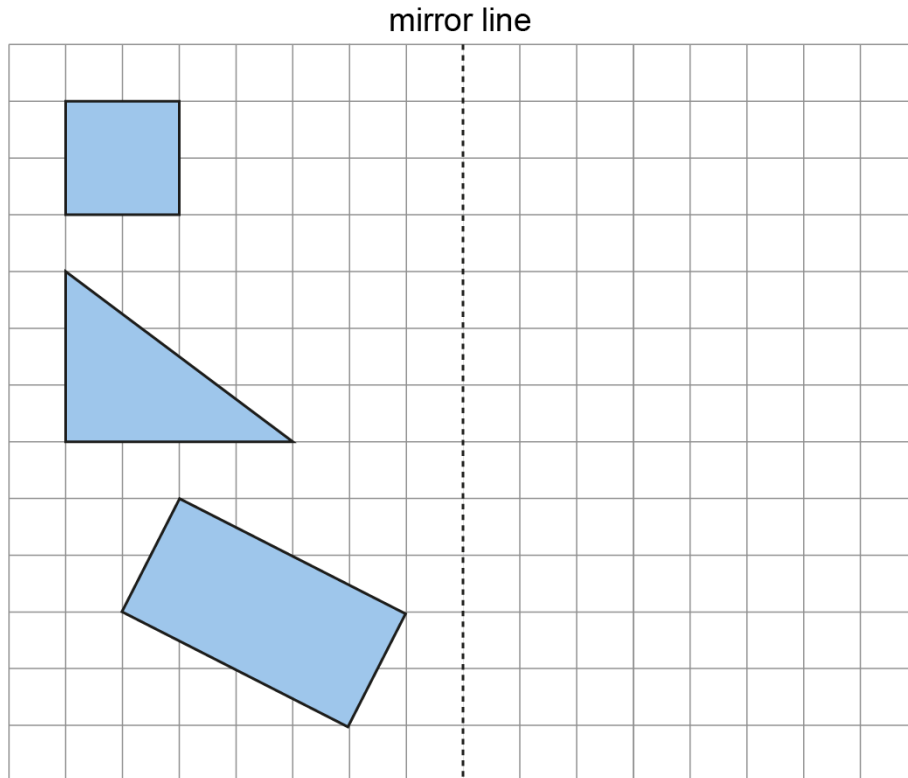

3. Complete the shape by reflecting it in the mirror line.

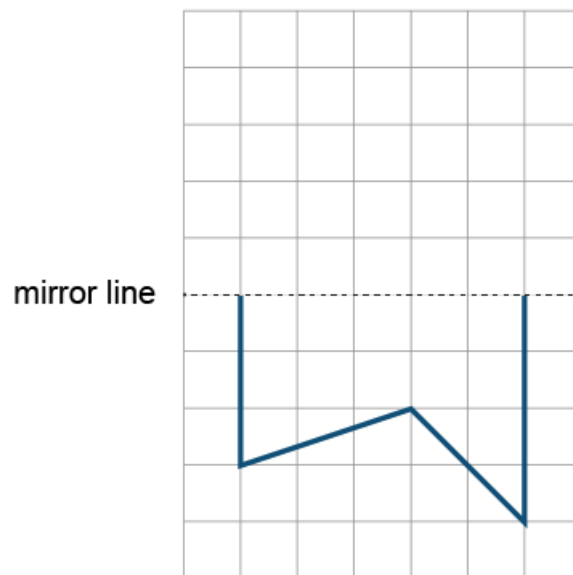

Name the polygon that you have completed.

4. Draw a line of symmetry on each shape. Are you able to draw more than one line of symmetry on any of the shapes?

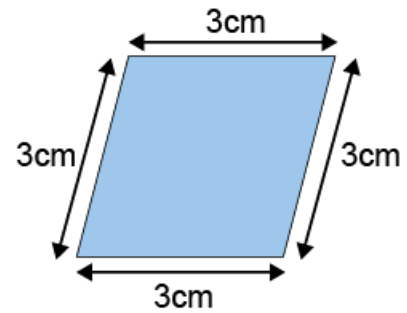
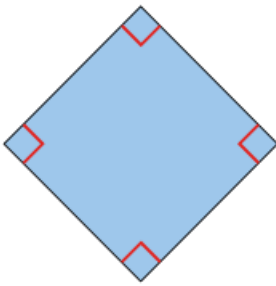

5. Complete the symmetrical pattern.

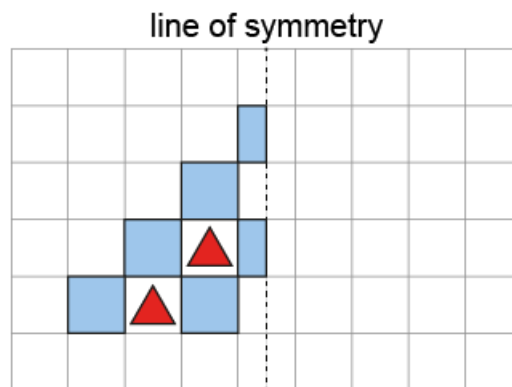

Calculation and fluency

Number, place value and number facts: 4NPV-2 and 4NF-3

- **4NPV-2** Recognise the place value of each digit in *four*-digit numbers, and compose and decompose four-digit numbers using standard and non-standard partitioning.
- **4NF-3** Apply place-value knowledge to known additive and multiplicative number facts (scaling facts by 100), for example:

$8 + 6 = 14$ and $14 - 6 = 8$	$3 \times 4 = 12$ and $12 \div 4 = 3$
so	so
$800 + 600 = 1,400$ and $1,400 - 600 = 800$	$300 \times 4 = 1,200$ and $1,200 \div 4 = 300$

Representations such as place-value counters and partitioning diagrams ([4NPV-2](#)) and tens-frames with place-value counters ([4NF-3](#)), can be used initially to help pupils understand calculation strategies and make connections between known facts and related calculations. However, pupils should not rely on such representations for calculating. For the calculations in **4NF-3**, for example, pupils should instead be able to calculate by verbalising the relationship.

Language focus

“8 plus 6 is equal to 14, so 8 hundreds plus 6 hundreds is equal to 14 hundreds.”

“14 hundred is equal to 1,400.”

Pupils should be developing fluency in both formal written and mental methods for addition and subtraction. Mental methods can include jottings to keep track of calculation, or language structures as exemplified above. Pupils should select the most efficient method to calculate depending on the numbers involved.

Addition and subtraction: extending 3AS–3

Pupils should also extend columnar addition and subtraction methods to four-digit numbers.

Pupils must be able to add 2 or more numbers using columnar addition, including calculations whose addends have different numbers of digits.

$$\begin{array}{r} 6,584 \\ + 2,739 \\ \hline 9,323 \\ \hline 1\ 1\ 1 \end{array}$$
$$\begin{array}{r} 3,362 \\ + 649 \\ \hline 4,011 \\ \hline 1\ 1\ 1 \end{array}$$
$$\begin{array}{r} 1,649 \\ 3,104 \\ + 516 \\ \hline 5,269 \\ \hline 1\ 1 \end{array}$$

Figure 150: columnar addition for calculations involving four-digit numbers

For calculations with more than 2 addends, pupils should add the digits within a column in the most efficient order. For the third example above, efficient choices could include:

- beginning by making 10 in the ones column
- making double-6 in the hundreds column

Pupils must be able to subtract one four-digit number from another using columnar subtraction. They should be able to apply the columnar method to calculations where the subtrahend has fewer digits than the minuend, and must be able to exchange through 0.

$$\begin{array}{r}
 \begin{array}{ccccccc}
 & 5 & 1 & 4 & 1 & 2 & 1 \\
 6, & 5 & 2 & 8 & & & \\
 - & 2, & 7 & 8 & 9 & & \\
 \hline
 3, & 7 & 4 & 9 & & &
 \end{array}
 &
 \begin{array}{r}
 2, 7 9 6 \\
 - \quad 4 8 5 \\
 \hline
 2, 3 1 1
 \end{array}
 &
 \begin{array}{r}
 \begin{array}{cccc}
 & 3 & 1 & 9 & 1 \\
 8, & 4 & 0 & 3 & \\
 - & 2, & 1 & 7 & 6 \\
 \hline
 6, & 2 & 2 & 7 &
 \end{array}
 \end{array}
 \end{array}$$

Figure 151: columnar subtraction for calculations involving four-digit numbers

Pupils should make sensible decisions about how and when to use columnar subtraction. For example, when the minuend is a multiple of 1,000, they may transform to an equivalent calculation before using column subtraction, avoiding the need to exchange through zeroes.

$$\begin{array}{r}
 7, 0 0 0 \\
 - 2, 6 4 8 \\
 \hline
 \hline
 \end{array}
 \xrightarrow[-1]{-1}
 \begin{array}{r}
 6, 9 9 9 \\
 - 2, 6 4 7 \\
 \hline
 \hline
 \end{array}$$

Figure 152: transforming a columnar subtraction calculation to an equivalent calculation

4NF–1 Recall of multiplication tables

Recall multiplication and division facts up to 12×12 , and recognise products in multiplication tables as multiples of the corresponding number.

Recall of all multiplication table facts should be the main multiplication calculation focus in year 4. Pupils who leave year 4 fluent in these facts have the best chance of mastering short multiplication in year 5.

Pupils who are fluent in multiplication table facts can solve the following types of problem by automatic recall of the relevant fact rather than by skip counting or reciting the relevant multiplication table:

- $8 \times 9 = \square$ $\square = 3 \times 12$ $6 \times 6 = \square$
 (identify products)
- $\square \times 5 = 45$ $8 \times \square = 48$ $121 = \square \times 11$
 (solve missing-factor problems)
- $35 \div 7 = \square$ $\square = 63 \div 9$
 (use relevant multiplication table facts to solve division problems)

Pupils should also be fluent in interpreting contextual multiplication and division problems, identifying the appropriate calculation and solving it using automatic recall of the relevant fact. Examples are given in [4NF-1 Example assessment questions](#).

As pupils become fluent with the multiplication table facts, they should also develop fluency in related calculations as described in [4NF-3](#) (scaling number facts by 100). Pupils should also develop fluency in multiplying and dividing by 10 and 100 ([4MD-1](#)).

4MD-2 Manipulating the multiplicative relationship

Manipulate multiplication and division equations, and understand and apply the commutative property of multiplication.

Pupils who are fluent in manipulating multiplicative expressions can solve the following types of problem:

- $\square \div 4 = 7$ $6 = \square \div 5$ $9 = \square \div 9$
(apply understanding of the inverse relationship between multiplication and division to solve missing-dividend problems)
- $72 \div \square = 8$ $35 \div \square = 5$ $81 \div \square = 9$
(solve missing-divisor problems)

To solve missing-divisor problems, pupils can use their understanding that the divisor and the quotient can be swapped, so that $72 \div \square = 8$, for example, is solved using $72 \div 8$. Alternatively they can use their understanding of the relationship between multiplication and division, and solve the related missing-factor problem (here $8 \times \square = 72$). In either case, pupils will then need to apply their multiplication table fluency (here '9 eights are 72') to finally identify the missing divisor.

Year 5 guidance

Ready-to-progress criteria

Year 4 conceptual prerequisite	Year 5 ready-to-progress criteria	Future applications
Know that 10 hundreds are equivalent to 1 thousand, and that 1,000 is 10 times the size of 100; apply this to identify and work out how many 100s there are in other four-digit multiples of 100.	<p>5NPV-1 Know that 10 tenths are equivalent to 1 one, and that 1 is 10 times the size of 0.1.</p> <p>Know that 100 hundredths are equivalent to 1 one, and that 1 is 100 times the size of 0.01.</p> <p>Know that 10 hundredths are equivalent to 1 tenth, and that 0.1 is 10 times the size of 0.01.</p>	<p>Solve multiplication problems that have the scaling structure, such as ‘ten times as long’.</p> <p>Understand that per cent relates to ‘number of parts per hundred’, and write percentages as a fraction with denominator 100, and as a decimal fraction.</p>
Recognise the place value of each digit in four-digit numbers, and compose and decompose four-digit numbers using standard and non-standard partitioning.	<p>5NPV-2 Recognise the place value of each digit in numbers with up to 2 decimal places, and compose and decompose numbers with up to 2 decimal places using standard and non-standard partitioning.</p>	<p>Compare and order numbers, including those with up to 2 decimal places.</p> <p>Add and subtract using mental and formal written methods.</p>
Reason about the location of any four-digit number in the linear number system, including identifying the previous and next multiple of 1,000 and 100, and rounding to the nearest of each.	<p>5NPV-3 Reason about the location of any number with up to 2 decimals places in the linear number system, including identifying the previous and next multiple of 1 and 0.1 and rounding to the nearest of each.</p>	<p>Compare and order numbers, including those with up to 2 decimal places.</p> <p>Estimate and approximate to the nearest 1 or 0.1.</p>
Divide 1,000 into 2, 4, 5 and 10 equal parts, and read scales/number lines marked in multiples of 1,000 with 2, 4, 5 and 10 equal parts.	<p>5NPV-4 Divide 1 into 2, 4, 5 and 10 equal parts, and read scales/number lines marked in units of 1 with 2, 4, 5 and 10 equal parts.</p>	<p>Read scales on graphs and measuring instruments.</p>

Year 4 conceptual prerequisite	Year 5 ready-to-progress criteria	Future applications
<p>Divide 100 and 1,000 into 2, 4, 5 and 10 equal parts.</p> <p>Find unit fractions of quantities using known division facts (multiplication tables fluency).</p>	<p>5NPV-5 Convert between units of measure, including using common decimals and fractions.</p>	<p>Read scales on measuring instruments, and on graphs related to measures contexts.</p> <p>Solve measures problems involving different units by converting to a common unit.</p>
<p>Recall multiplication and division facts up to 12×12.</p> <p>Solve division problems, with two-digit dividends and one-digit divisors, that involve remainders, for example: $74 \div 9 = 8 \text{ r } 2$</p>	<p>5NF-1 Secure fluency in multiplication table facts, and corresponding division facts, through continued practice.</p>	<p>Use multiplication facts during application of formal written layout.</p> <p>Use division facts during short division and long division.</p>
<p>Apply place-value knowledge to known additive and multiplicative number facts (scaling facts by 10 or 100), for example:</p> <p>$8 + 6 = 14$ $80 + 60 = 140$ $800 + 600 = 1,400$</p> <p>$3 \times 4 = 12$ $30 \times 4 = 120$ $300 \times 4 = 1,200$</p>	<p>5NF-2 Apply place-value knowledge to known additive and multiplicative number facts (scaling facts by 1 tenth or 1 hundredth), for example:</p> <p>$8 + 6 = 14$ $0.8 + 0.6 = 1.4$ $0.08 + 0.06 = 0.14$</p> <p>$3 \times 4 = 12$ $0.3 \times 4 = 1.2$ $0.03 \times 4 = 0.12$</p>	<p>Recognise number relationships within the context of place value to develop fluency and efficiency in calculation.</p>
<p>Multiply and divide whole numbers by 10 and 100 (keeping to whole number quotients); understand this as equivalent to scaling a number by 10 or 100.</p>	<p>5MD-1 Multiply and divide numbers by 10 and 100; understand this as equivalent to making a number 10 or 100 times the size, or 1 tenth or 1 hundredth times the size.</p>	<p>Convert between different metric units of measure.</p>

Year 4 conceptual prerequisite	Year 5 ready-to-progress criteria	Future applications
<p>Recall multiplication and division facts up to 12×12, and recognise products in multiplication tables as multiples of the corresponding number.</p> <p>Recognise multiples of 10, 100 and 1,000.</p> <p>Apply place-value knowledge to known additive and multiplicative number facts.</p> <p>Multiply and divide whole numbers by 10 and 100 (keeping to whole number quotients).</p>	<p>5MD-2 Find factors and multiples of positive whole numbers, including common factors and common multiples, and express a given number as a product of 2 or 3 factors.</p>	<p>Solve contextual division problems.</p> <p>Simplify fractions.</p> <p>Express fractions in the same denomination.</p>
<p>Recall multiplication facts up to 12×12.</p> <p>Manipulate multiplication and division equations.</p>	<p>5MD-3 Multiply any whole number with up to 4 digits by any one-digit number using a formal written method.</p>	<p>Solve contextual and non-contextual multiplication problems using a formal written method.</p>
<p>Recall multiplication and division facts up to 12×12.</p> <p>Manipulate multiplication and division equations.</p> <p>Solve division problems, with two-digit dividends and one-digit divisors, that involve remainders, for example: $74 \div 9 = 8 \text{ r } 2$ and interpret remainders appropriately according to the context.</p>	<p>5MD-4 Divide a number with up to 4 digits by a one-digit number using a formal written method, and interpret remainders appropriately for the context.</p>	<p>Solve contextual and non-contextual division problems using a formal written method.</p>
<p>Recall multiplication and division facts up to 12×12.</p> <p>Find unit fractions of quantities using known division facts (multiplication-tables fluency).</p> <p>Unitise using unit fractions (for example, understand that there are 3 one-fifths in three-fifths).</p>	<p>5F-1 Find non-unit fractions of quantities.</p>	<p>Solve multiplication problems that have the scaling structure.</p>

Year 4 conceptual prerequisite	Year 5 ready-to-progress criteria	Future applications
<p>Recall multiplication and division facts up to 12×12.</p> <p>Reason about the location of fractions in the linear number system.</p>	<p>5F-2 Find equivalent fractions and understand that they have the same value and the same position in the linear number system.</p>	<p>Compare and order fractions.</p> <p>Use common factors to simplify fractions.</p> <p>Use common multiples to express fractions in the same denomination.</p> <p>Add and subtract fractions with different denominators and mixed numbers, using the concept of equivalent fractions.</p>
<p>Divide powers of 10 into 2, 4, 5 and 10 equal parts.</p>	<p>5F-3 Recall decimal fraction equivalents for $\frac{1}{2}$, $\frac{1}{4}$, $\frac{1}{5}$ and $\frac{1}{10}$, and for multiples of these proper fractions.</p>	<p>Read scales on graphs and measuring instruments.</p> <p>Know percentage equivalents of common fractions.</p>
<p>Recognise right angles as a property of shape or a description of a turn, and identify right angles in 2D shapes presented in different orientations.</p> <p>Identify whether the interior angles of a polygon are equal or not.</p>	<p>5G-1 Compare angles, estimate and measure angles in degrees ($^{\circ}$) and draw angles of a given size.</p>	<p>Solve problems involving missing angles.</p>
<p>Compose polygons from smaller shapes.</p> <p>Recall multiplication facts up to 12×12.</p>	<p>5G-2 Compare areas and calculate the area of rectangles (including squares) using standard units.</p>	<p>Calculate the area of compound rectilinear shapes and other 2D shapes, including triangles and parallelograms, using standard units.</p> <p>Use the relationship between side-length and perimeter, and between side-length and area to calculate unknown values.</p>

5NPV–1 Tenths and hundredths

Know that 10 tenths are equivalent to 1 one, and that 1 is 10 times the size of 0.1.
Know that 100 hundredths are equivalent to 1 one, and that 1 is 100 times the size of 0.01.

Know that 10 hundredths are equivalent to 1 tenth, and that 0.1 is 10 times the size of 0.01.

5NPV–1 Teaching guidance

This criterion follows on from what pupils learnt in years 3 and 4 about the relationship between adjacent place-value positions. The value of a given digit is made 10 times the size if it is moved 1 position to left, and is made one tenth times the size if it is moved 1 position to the right. Pupils should learn, therefore, that we can extend the place-value chart to include positions to the right of the ones place.

The diagram shows a place-value chart with six columns: 1,000s, 100s, 10s, 1s, 0.1s, and 0.01s. The chart is a 6x6 grid. The top row contains the place value labels. The second row has a '1' in the 1,000s column. The third row has a '1' in the 100s column. The fourth row has a '1' in the 10s column. The fifth row has a '1' in the 1s column. The sixth row has a '1' in the 0.1s column. The seventh row has a '1' in the 0.01s column. Above the chart, five blue curved arrows point from right to left between adjacent columns, each labeled 'ten times the size'. Below the chart, five blue curved arrows point from left to right between adjacent columns, each labeled 'one tenth the size'.

1,000s	100s	10s	1s	0.1s	0.01s
1					
	1				
		1			
			1		
				1	
					1

Figure 153: place-value chart illustrating the scaling relationship between adjacent positions, including tenths and hundredths

Pupils should understand that:

- a '1' in the tenths column has a value of one tenth, and is one tenth the size of 1
- a '1' in the hundredths column has a value of one hundredth, and is one hundredth the size of 1

Pupils should learn that the decimal point is used between the ones digit and the tenths digit, so that we can write decimal numbers without using a place-value chart. They should learn that one tenth is written as 0.1 and one hundredth is written as 0.01.

Pupils must be able to describe the relationships between 1, 0.1 and 0.01.

Language focus

“1 is 10 times the size of one-tenth.”

“One-tenth is 10 times the size of one-hundredth.”

“1 is 100 times the size of one-hundredth.”

As well as understanding one-tenth and one-hundredth as scaling 1, pupils must understand them in terms of regrouping and exchanging. Dienes can be used to illustrate the relative size of 1, one-tenth and one-hundredth, with a ‘flat’ now representing 1. Pupils should experience how 10 hundredths can be regrouped into one-tenth, and how both 10 tenths and 100 hundredths can be regrouped into 1 one. Conversely they should be able to exchange 1 one for 10 tenths or for 100 hundredths and 1 tenth for 10 hundredths.

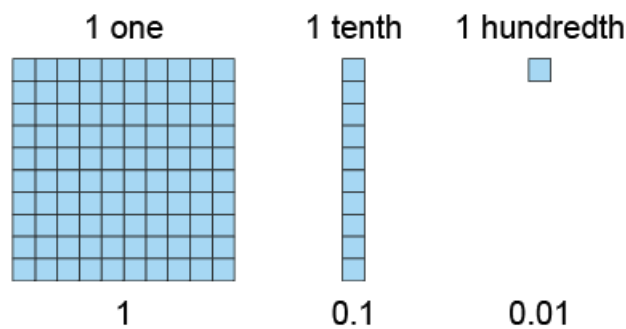

Figure 154: using Dienes to represent 1, one-tenth and one-hundredth

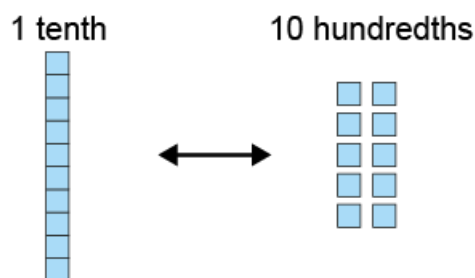

Figure 155: using Dienes to represent the equivalence of 1 tenth and 10 hundredths

Pupils must describe the equivalence between the different quantities using unitising language (unitising in ones, tenths and hundredths).

Language focus

“10 tenths is equal to 1 one.”

“10 hundredths is equal to 1 tenth.”

“100 hundredths is equal to 1 one.”

Once pupils understand the relative size of these new units, they should learn to use place-value counters to represent the equivalence. Pupils must then be able to work out how many tenths there are in other multiples of 0.1 and how many hundredths there are in other multiples of 0.01. Initially pupils should work with values that involve only the tenths place (for example 0.4) or only the hundredths place (for example 0.04). Once they have learnt to write numbers with tenths and hundredths ([5NPV-2](#)), they should be able to reason, for example, that:

- 18 hundredths is equal to 1 tenth and 8 hundredths, and is written as 0.18
- 18 tenths is equal to 1 one and 8 tenths, and is written as 1.8



Figure 156: eighteen 0.01-value place-value counters in 2 tens frames

Language focus

“18 hundredths is equal to 10 hundredths and 8 more hundredths.”

“10 hundredths is equal to 1 tenth.”

“So 18 hundredths is equal to 1 tenth and 8 more hundredths, which is 0.18.”

Pupils need to be able to apply this reasoning to measures contexts, as shown in the Example assessment questions below.

This learning should also be connected to pupils' understanding of fractions – they should understand that one-tenth can be written as both 0.1 and $\frac{1}{10}$ and that one hundredth can be written as both 0.01 and $\frac{1}{100}$. Pupils should be able to write, for example, 18 hundredths as both 0.18 and $\frac{18}{100}$.

Making connections

Pupils need to be able to write numbers in decimal notation (**5NPV-2**) to be able to make the connection between, for example 18 tenths and 1.8. Meeting **5NPV-1** also supports **5NF-2** (applying place value to known number facts) because, if pupils can unitise in tenths and hundredths, and, for example understand that 12 tenths = 1.2 and 12 hundredths = 0.12, then they can reason that:

- $0.5 + 0.7 = 1.2$ (5 tenths plus 7 tenths is equal to 12 tenths, which is 1.2)
- $0.03 \times 4 = 0.12$ (3 hundredths times 4 is equal to 12 hundredths, which is 0.12)

5NPV-1 Example assessment questions

1. An apple weighs about 0.1kg. Approximately how many apples are there in a 1.8kg bag?
2. I have a 0.35m length of wooden rod. How many 0.01m lengths can I cut it into?
3. Mrs Jasper is juicing oranges. Each orange makes about 0.1 litres of juice. If Mrs Jasper juices 22 oranges, approximately how many litres of orange juice will she get?
4. Circle all of the numbers that are equal to a whole number of tenths.

0.2 4.8 1 0.01 10 0.83

5. Fill in the missing numbers.

$$0.01 \times \boxed{} = 1 \qquad 0.1 \times \boxed{} = 1 \qquad 0.01 \times \boxed{} = 0.1$$

6. Fill in the missing numbers.

$$\boxed{} \text{ tenths} = 3.9$$

$$\boxed{} \text{ hundredths} = 0.22$$

$$\boxed{} \text{ hundredths} = 8$$

7. Match the numbers on the left with the equivalent fractions on the right.

0.20	$\frac{2}{100}$
0.02	$\frac{21}{100}$
0.12	$\frac{2}{10}$
0.21	$\frac{12}{100}$

5NPV–2 Place value in decimal fractions

Recognise the place value of each digit in numbers with up to 2 decimal places, and compose and decompose numbers with up to 2 decimal places using standard and non-standard partitioning.

5NPV–2 Teaching guidance

Pupils must be able to read, write and interpret decimal fractions with up to 2 decimal places. Pupils should work first with decimal fractions with one significant digit (for example, 0.3 and 0.03). The Gattegno chart is a useful tool here.

1,000	2,000	3,000	4,000	5,000	6,000	7,000	8,000	9,000
100	200	300	400	500	600	700	800	900
10	20	30	40	50	60	70	80	90
1	2	3	4	5	6	7	8	9
0.1	0.2	0.3	0.4	0.5	0.6	0.7	0.8	0.9
0.01	0.02	0.03	0.04	0.05	0.06	0.07	0.08	0.09

Figure 157: Gattegno chart showing thousands, hundreds, tens, ones, tenths and hundredths

The number 300 is spoken as “three hundred” rather than as “three-zero-zero”, and this helps pupils to identify the value of the 3 in 300. However, decimal fractions are usually spoken as digits, for example, 0.03 is spoken as “zero-point-zero-three” (or “nought-point-nought-three”) rather than “three hundredths”. As such, pupils need to practise speaking decimal fractions in both ways and learn to convert from one to the other.

Language focus

“Three hundredths is zero-point-zero-three.”

Pupils must then learn to work with decimal fractions with 2 significant digits (for example, 0.36). For any given decimal fraction of this type, pupils must be able to connect the spoken words (zero-point-three-six), the value in decimal notation (0.36), describing the number of tenths and hundredths (3 tenths and 6 hundredths) and visual representations (such as place-value counters and the Gattegno chart).

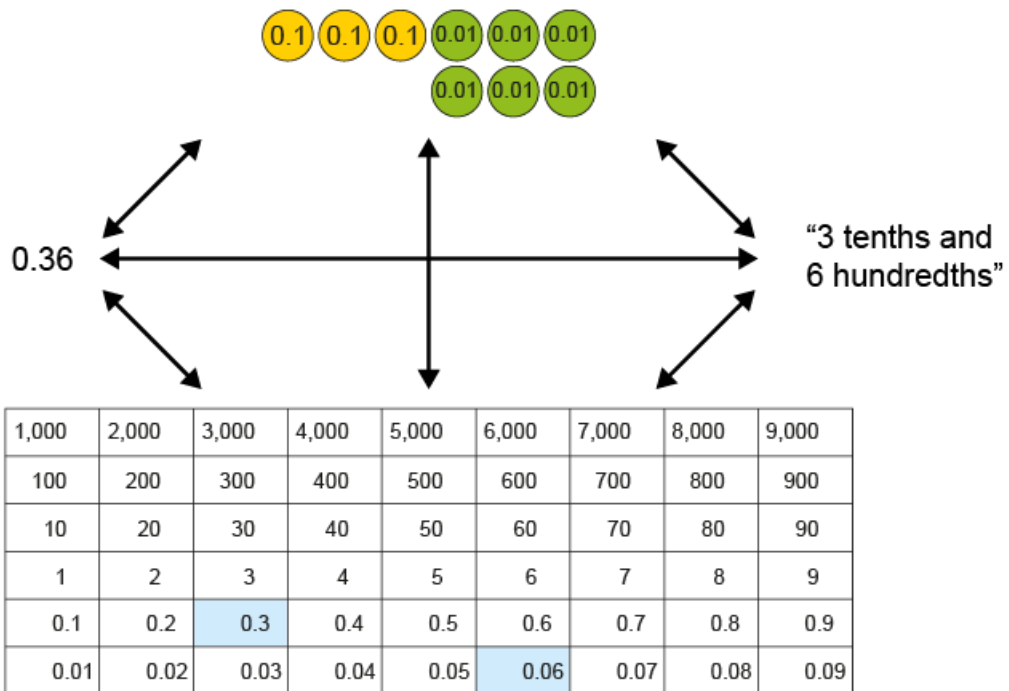

Figure 158: 4 different representations of 0.36

Pupils should be able to identify the place value of each digit in numbers with up to 2 decimal places. They must be able to combine units of hundredths, tenths, ones, tens, hundreds and thousands to compose numbers, and partition numbers into these units. Pupils need to experience variation in the order of presentation of the units, so that they understand that $0.4 + 3 + 0.02 + 50$ is equal to 53.42, not 43.25.

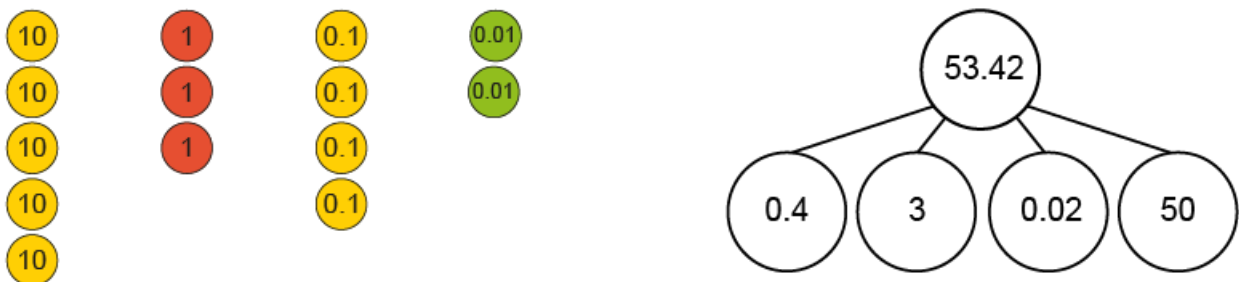

Figure 159: 2 representations of the place-value composition of 53.42

Pupils also need to solve problems relating to subtraction of any single place-value part from the whole number, for example:

$$53.42 - 3 = \square$$

$$53.42 - \square = 53.02$$

As well as being able to partition numbers in the 'standard' way (into individual place-value units), pupils must also be able to partition numbers in 'non-standard' ways and carry out related addition and subtraction calculations, for example:

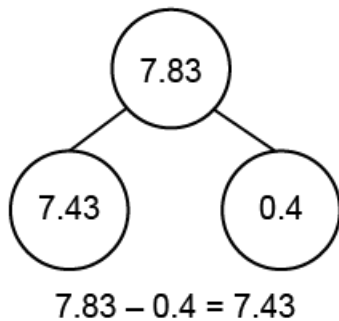

Figure 160: partitioning 7.83 into 7.43 and 0.4

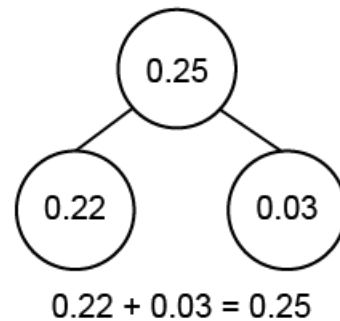

Figure 161: partitioning 0.25 into 0.22 and 0.03

You can find out more about fluency and recording for these calculations here in the calculation and fluency section: [Number, place value and number facts: 5NPV-2 and 5NF-2](#)

5NPV-2 Example assessment questions

1. Complete the calculations.

$$4 + 0.07 + 0.2 = \square$$

$$0.4 + 0.02 + 70 = \square$$

$$20 + 0.07 + 4 = \square$$

$$0.4 + 20 + 700 = \square$$

2. Circle the numbers that add together to give a total of 0.14

0.04

0.12

0.1

0.2

3. Fill in the missing numbers.

$3.87 - 0.8 = \square$

$25.14 - 0.04 = \square$

$19.7 - 9 = \square$

$99.99 - 90 = \square$

$84.51 = 50 + \square$

$0.3 + 5.61 = \square$

$95.75 - 0.5 = \square$

$6.14 = 5 + \square + 0.04$

$2 + 1.43 + 0.05 = \square$

- I have 3.7kg of modelling clay. If we use 2kg, how much will be left?
- I will use 0.65 litres of milk for one recipe, and 0.23 litres of milk for another. How much milk will I use altogether?
- Ilaria jumped 3.19m in a long jump competition. Emma jumped 3.12m. How much further did Ilaria jump than Emma?
- Maya cycled 7.3km to get to her friend's house, and then cycled a further 0.6km to the park. How far did Maya cycle altogether?

5NPV-3 Decimal fractions in the linear number system

Reason about the location of any number with up to 2 decimal places in the linear number system, including identifying the previous and next multiple of 1 and 0.1 and rounding to the nearest of each.

5NPV-3 Teaching guidance

Pupils need to become familiar with the relative positions, on a number line, of numbers with 1 and 2 decimal places. They will need to see number lines with both tenths and intermediate hundredths values marked, and learn, for example, that 0.5 is the same as 0.50 and 3 is the same as 3.0 or 3.00. Pupils should recognise the magnitude and position of a given decimal fraction, irrespective of the precision it is given to, for example, 5 tenths lies between 0.45 and 0.55 on the number line below, whether it is represented as 0.5 or 0.50.

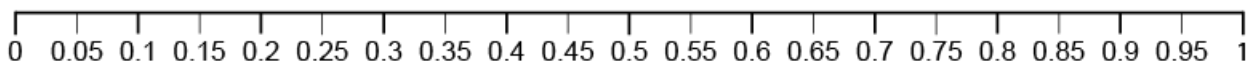

Figure 162: 0 to 1 number line marked and labelled in intervals of 5 hundredths

Pupils need to be able to identify or place decimal fractions on number lines marked in tenths and/or hundredths. They should use efficient strategies and appropriate reasoning, including identifying the midpoints or working backwards from a whole number or a multiple of one tenth.

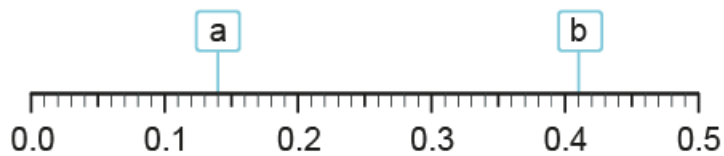

Figure 163: identifying 0.14 and 0.41 on a 0 to 0.5 number line marked with intervals of hundredths

Language focus

“a is 0.14 because it is 1 hundredth less than the midpoint of 0.1 and 0.2, which is 0.15.”

“b is 0.41 because it is 1 hundredth more than 0.4.”

Pupils need to be able to estimate the value or position of decimal fractions on unmarked or partially marked numbers lines, using appropriate proportional reasoning, rather than counting on from a start point or back from an end point. For example, here pupils should reason: “8.6 is about *here* on the number line because it’s just over half way”.



Figure 164: placing 8.6 on an unmarked 8 to 9 number line

Here, pupils should reason: “8.75 is about *here* on the number line because it’s the midpoint of 8.7 and 8.8.”

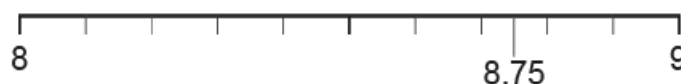

Figure 165: placing 8.75 on an 8 to 9 number line marked only in tenths

Pupils must also be able to identify which whole numbers, or which pair of multiples of 0.1, a given decimal fraction is between. To begin with, pupils can use a number line for support. In this example, for the number 8.61, pupils must identify the previous and next whole number, and the previous and next multiple of 0.1.

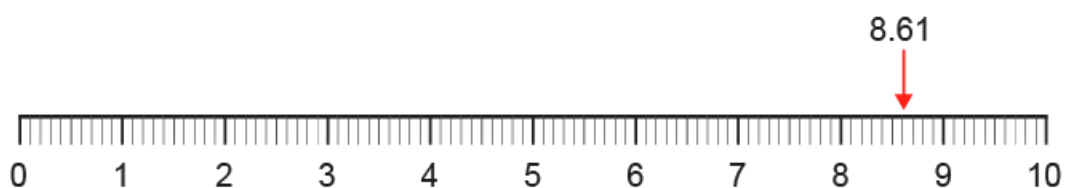

Figure 166: using a number line to identify the previous and next whole number

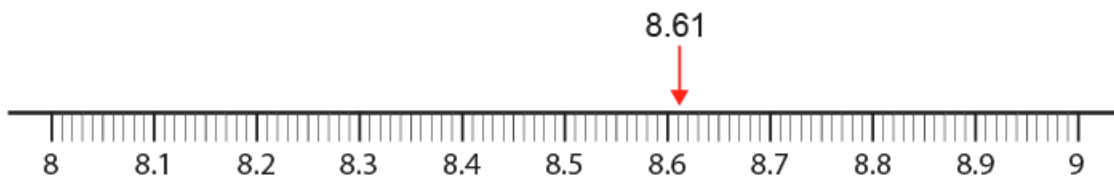

Figure 167: using a number line to identify the previous and next multiple of 0.1

Language focus

“The previous whole number is 8. The next whole number is 9.”

“The previous multiple of 0.1 is 8.6. The next multiple of 0.1 is 8.7.”

By the end of year 5 pupils need to be able to complete this type of task without the support of a number line.

Pupils should then learn to round a given decimal fraction to the nearest whole number by identifying the nearest of the pair of whole numbers that the decimal fraction is between. Similarly, pupils should learn to round to the nearest multiple of 0.1. They should understand that they need to examine the digit in the place to the right of the unit they are rounding to, for example when rounding to the nearest whole number, pupils must examine the digit in the tenths place. Again, pupils can initially use number lines for support, but should be able to round without that support by the end of year 5.



Figure 168: identifying the nearest whole number with a number line for support

Language focus

“The closest whole number is 9.”

“8.61 rounded to the nearest whole number is 9.”

Finally, pupils should also be able to count forwards and backwards from any decimal fraction in steps of 1, 0.1 or 0.01. Pay particular attention to counting over ‘boundaries’, for example:

- 2.1, 2.0, 1.9
- 2.85, 2.95, 3.05

Making connections

Here, pupils must apply their knowledge that 10 tenths is equal to 1 one (see [5NPV-1](#)) to understand that each interval of 1 on a number line or scale is made up of 10 intervals of 0.1. Similarly, they must use their knowledge that 10 hundredths is equal to 1 tenth to understand that each interval of 0.1 on a number line or scale is made up of 10 intervals of 0.01. This also links to [5NPV-4](#), in which pupils need to be able to read scales divided into 2, 4, 5 and 10 equal parts.

5NPV-3 Example assessment questions

1. Place each of these numbers on the number line.

0.6 0.16 0.91 0.09 0.69

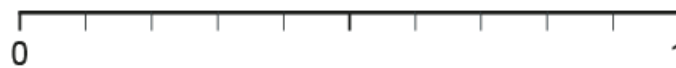

2. The table shows how far some children jumped in a long-jump competition.

Name	Distance jumped (m)
Jamal	3.04
Reyna	3.4
Faisal	2.85
Ilaria	3.19
Charlie	3.09
Kagendo	2.9

- Who jumped the furthest and won the competition?
- Who came third in the competition?

c. How much further did Kagendo jump than Faisal?

d. How much further did Ilaria jump than Charlie?

3. Fill in the missing symbols (<, > or =).

$0.3 \bigcirc 0.5$

$0.03 \bigcirc 0.05$

$0.50 \bigcirc 0.5$

$9 \bigcirc 9.00$

$0.2 \bigcirc 0.15$

$0.11 \bigcirc 0.09$

$1.01 \bigcirc 1.1$

$3 \bigcirc 2.99$

$140 \bigcirc 1.40$

4. Here is a weighing scale. Estimate the mass in kilograms that the arrow is pointing to.

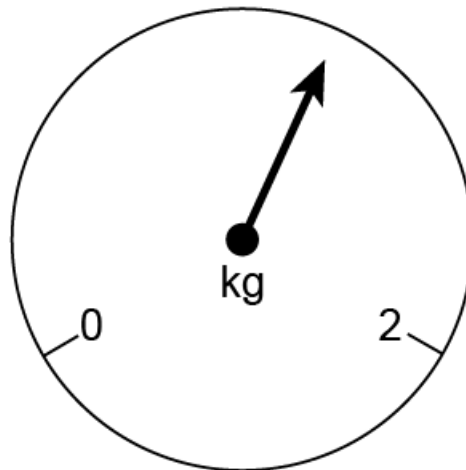

5. Estimate and mark the position of 0.7 litres on this beaker.

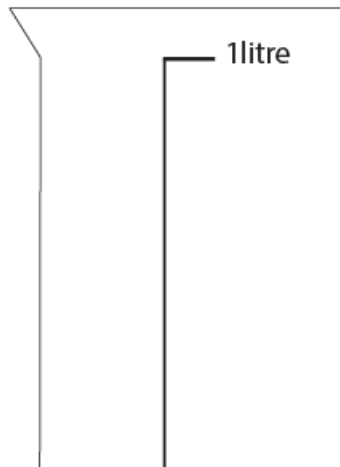

6. Fill in the missing numbers.

			5.01	5.02	5.03		
3.65			3.95			4.25	4.35
			27.9	27.8	27.7		

7. A farmer weighed each of 6 new-born lambs. Round the mass of each lamb to the nearest whole kilogram.

	Rounded to nearest whole kilogram
5.19kg	
6.7kg	
4.08kg	
6.1kg	
6.45kg	
4.91kg	

8. I need 4.25 metres of ribbon.

- How much is this to the nearest tenth of a metre?
- How much is this to the nearest metre?
- If ribbon is sold only in whole metres, how many metres do I need to buy?

5NPV–4 Reading scales with 2, 4, 5 or 10 intervals

Divide 1 into 2, 4, 5 and 10 equal parts, and read scales/number lines marked in units of 1 with 2, 4, 5 and 10 equal parts.

5NPV–4 Teaching guidance

By the end of year 5, pupils must be able to divide 1 into 2, 4, 5 or 10 equal parts. This is important because these are the intervals commonly found on measuring instruments and graph scales.

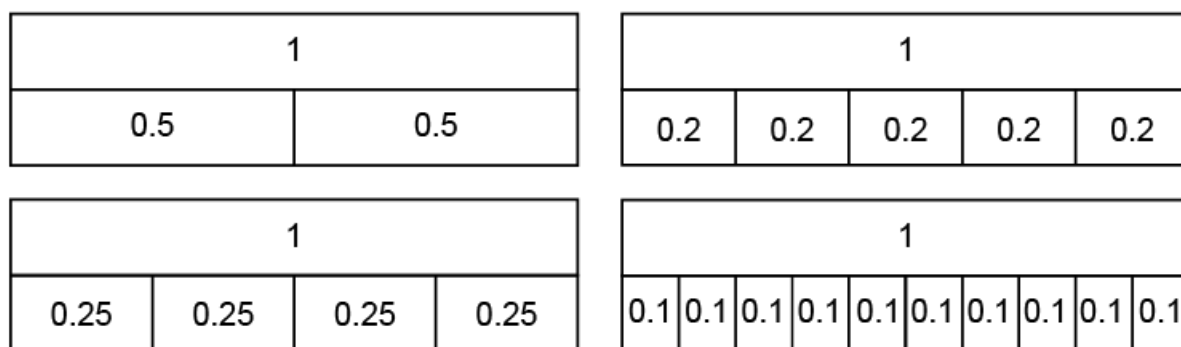

Figure 169: bar models showing 1 partitioned into 2, 4, 5 and 10 equal parts

Pupils should practise counting in multiples of 0.1, 0.2, 0.25 and 0.5 from 0, or from any multiple of these numbers, both forwards and backwards. This is an important step in becoming fluent with these number patterns.

Language focus

“Twenty-five, fifty, seventy-five, one hundred” needs to be a fluent spoken language pattern. Fluency in this language pattern provides the basis to count in multiples of 0.25.

Pupils should be able to apply this skip counting, beyond 1, to solve contextual multiplication and division measures problems, as shown in [5NPV–4 Example assessment questions](#) below (questions 8 to 10). Pupils should also be able to write, solve and manipulate multiplication and division equations related to multiples of 0.1, 0.2, 0.25 and 0.5 up to 1, and connect this to their knowledge of fractions, and decimal-fraction equivalents ([5F–3](#)).

Pupils need to be able to solve addition and subtraction problems based on partitioning 1 into multiples of 0.1, 0.2 and 0.5 based on known number bonds to 10. Pupils should also have automatic recall of the fact that 0.25 and 0.75 are bonds to 1. They should be able to immediately answer a question such as “I have 1 litre of water and pour out 0.25 litres. How much is left?”

Making connections

Dividing 1 into 10 equal parts is also assessed as part of [5NPV-1](#).

Reading scales also builds on number-line knowledge from [5NPV-3](#). Conversely, experience of working with scales with 2, 4, 5 or 10 divisions in this criterion improves pupils’ estimating skills when working with unmarked number lines and scales as described in [5NPV-3](#).

In [5F-3](#) pupils need to be fluent in common fraction–decimal equivalents, for example, $\frac{3}{4} = 0.75$. This criterion provides the foundations for [5F-3](#).

5NPV-4 Example assessment questions

1. Fill in the missing parts, and write as many different equations as you can think of to represent the bar model.

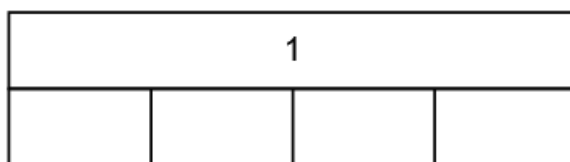

2. Fill in the missing numbers.

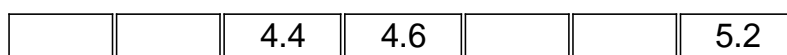
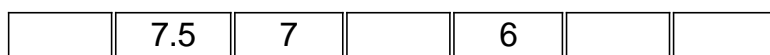

3. 5 children have been growing sunflowers. The bar chart shows how tall each child's sunflower has grown. How tall is each flower?

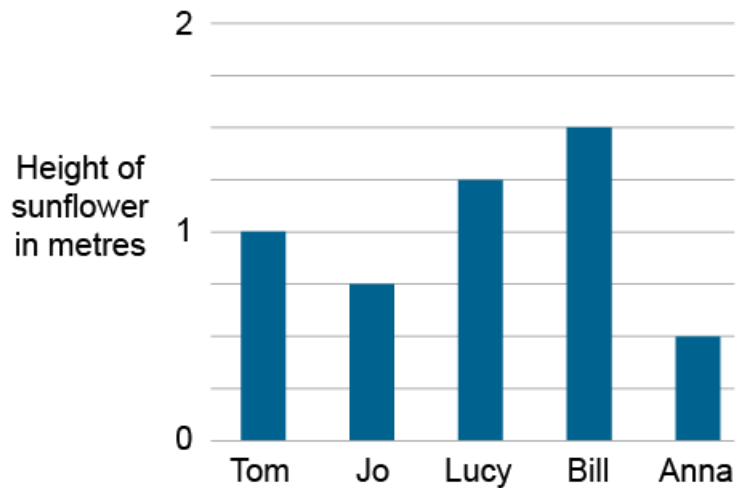

4. The bar chart below shows long-jump distances for 6 children.

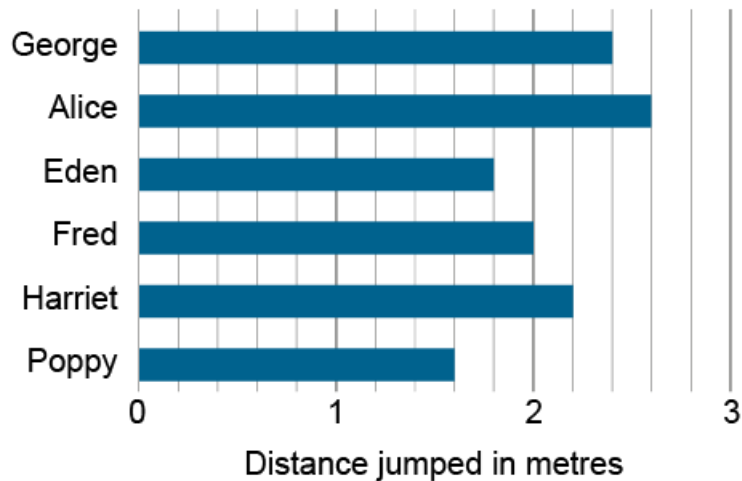

- a. How far did the winning child jump?
 b. What was the difference between the two longest jumps?
5. Complete the labelling of these scales.

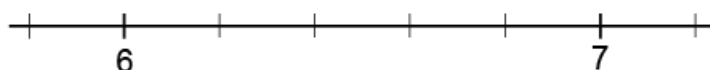
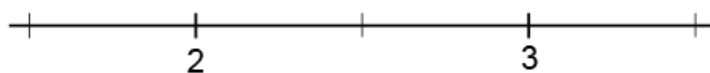
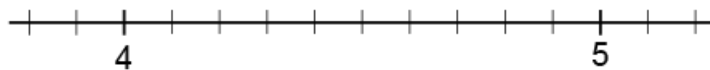
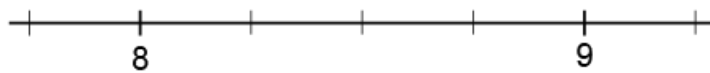

6. What is the reading on each of these scales, in kilograms?

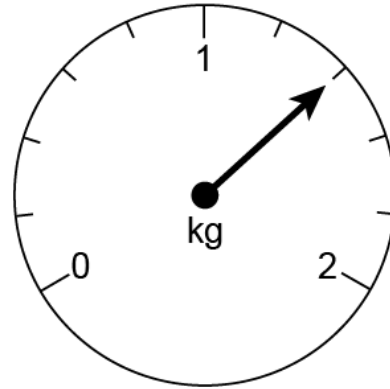
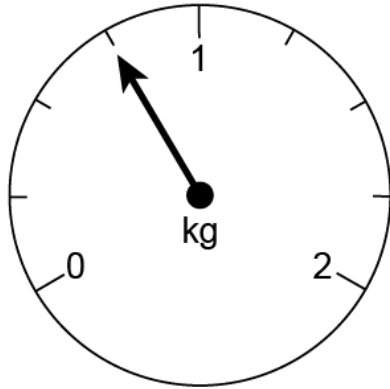

7. Here is a 1 litre beaker with some liquid in. How much more liquid, in litres, do I need to add to the beaker to make 1 litre?

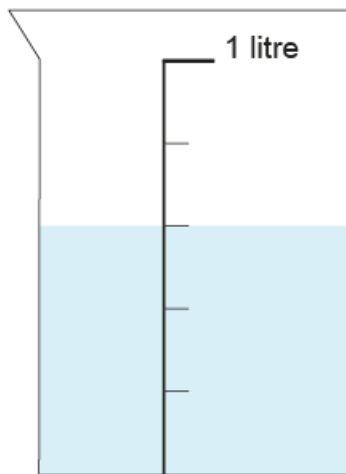

8. A motorway repair team can build 0.2km of motorway barrier in 1 day. In 6 working days, how many kilometres of motorway barrier can they build?

9. How many 0.25 litre servings of orange juice are there in a 2 litre carton?

10. 0.25m of ribbon costs £1. How much does 2m of ribbon cost?

11. Fill in the missing numbers.

$$1 - 0.2 = \square$$

$$5 \times \square \text{ m} = 1 \text{ m}$$

$$1 \div 5 = \square$$

$$1 - 0.8 = \square$$

$$4 \times \square \text{ m} = 1 \text{ m}$$

$$1 \div 5 = 1 - \square$$

$$1 - \square = 1 - 0.2 - 0.2$$

$$5 \times 0.2 \text{ m} = 4 \times \square \text{ m}$$

12. Here is a part of a number line divided into 4 equal parts.

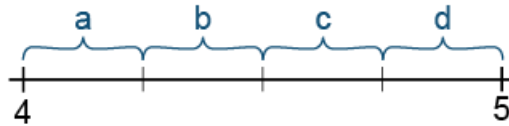

In which section (a, b, c or d) does each of these numbers belong? Explain your answers.

4.3 4.03 4.09 4.76 4.41 4.69

5NPV–5 Convert between units of measure

Convert between units of measure, including using common decimals and fractions.

5NPV–5 Teaching guidance

Pupils should first memorise the following unit conversions:

1km = 1,000m

1m = 100cm

1cm = 10mm

1 litre = 1,000ml

1kg = 1,000g

£1 = 100p

It is essential that enough time is given to this foundational stage before moving on. Practical experience of these conversions will help pupils to avoid common errors in recalling the correct power of 10 for a given conversion. For example, they can walk 1km while counting the number of metres using a trundle measuring wheel.

Once pupils can confidently recall these conversions, they should apply them to whole number conversions, from larger to smaller units and vice versa, for example, £4 = 400p and 8,000g = 8kg. Pupils must then learn to convert from and to fraction and decimal-fraction quantities of larger units, within 1, for example 0.25km = 250m. They should be able to carry out conversions that correspond to some of the common 2, 4, 5 and 10 part measures intervals, as exemplified below for kilometre–metre conversions.

Distance in km expressed as a fraction	Distance in km expressed as a decimal fraction	Distance in metres
$\frac{1}{5}$ km	0.2km	200m
$\frac{1}{4}$ km	0.25km	250m
$\frac{1}{2}$ km	0.5km	500m
$\frac{3}{4}$ km	0.75m	750m
$\frac{1}{10}$ km	0.1km	100m
all other multiples of $\frac{1}{10}$ km, for example, $\frac{7}{10}$ km	0.7km	700m

For finding $\frac{3}{4}$ of a unit, pupils should have sufficient fluency in the association between $\frac{3}{4}$ and 0.75, 75 and 750 that they should not need to first work out $\frac{1}{4}$ and multiply by 3.

For all conversions, pupils should begin by stating the single unit conversion rate as a step to the fraction or decimal-fraction conversion.

Language focus

“1m is 100cm.”

“So $\frac{3}{4}$ m is 75cm.”

Pupils should learn to derive other common conversions over 1. To convert, for example, 3,700 millilitres to litres, they should not need to think about dividing by 1,000 and moving the digits 3 places. Instead they should be able to use single unit conversion rates and their understanding of place value.

Language focus

“1,000ml is 1 litre.”

“So 3,000ml is 3 litres, and 3,700ml is 3.7 litres.”

For pounds and pence, and metres and centimetres, pupils should also be able to carry out conversions that correspond to 100 parts, for example, 52p = £0.52, and 43cm = 0.43m.

Language focus

“100p is £1.”

“So 50p is £0.50, and 52p is £0.52.”

Pupils can use ratio tables for support.

1m	100cm	1,000ml	1 litre	100p	£1
$\frac{3}{4}$ m	75cm	3,700ml	3.7 litres	52p	£0.52

Pupils must learn to solve measures problems involving different units by converting to a common unit.

Making connections

To succeed with this criterion, pupils must be fluent in the division of 1,000, 100 and 1 into 2, 4, 5 and 10 equal parts ([4NPV-4](#) , [3NPV-4](#) and [5NPV-4](#) respectively). They must also be able to recall common fraction-decimal equivalents ([5F-3](#)). The fraction conversions in this criterion are special cases of finding fractions of quantities ([5F-1](#)).

5NPV-5 Example assessment questions

1. Fill in the missing numbers to complete these conversions between units.

$1.8 \text{ litres} = \boxed{} \text{ ml}$

$\frac{3}{4} \text{ km} = \boxed{} \text{ m}$

$5\frac{1}{2} \text{ cm} = \boxed{} \text{ mm}$

$\pounds 8.12 = \boxed{} \text{ p}$

$4\frac{1}{4} \text{ kg} = \boxed{} \text{ g}$

$3.4 \text{ m} = \boxed{} \text{ cm}$

$21 \text{ mm} = \boxed{} \text{ cm}$

$2,250 \text{ ml} = \boxed{} \text{ litres}$

$650 \text{ cm} = \boxed{} \text{ m}$

$8,300 \text{ m} = \boxed{} \text{ km}$

$165 \text{ p} = \pounds \boxed{}$

$750 \text{ g} = \boxed{} \text{ kg}$

2. Put these volumes in order from smallest to largest.

0.75 litres

1.1 litres

0.3 litres

$\frac{1}{5}$ litre

900ml

$1\frac{1}{2}$ litres

3. Put these lengths in order from smallest to largest.

0.45m

10mm

208cm

$2\frac{1}{2}$ m

80cm

0.9m

$\frac{1}{2}$ cm

4. Maya needs to post 3 parcels. The mass of each parcel is shown below. How much do the parcels weigh altogether, in kilograms?

Parcel	Mass of parcel
A	3.2kg
B	4,500g
C	$1\frac{1}{2}$ kg

5. Finn has a $7\frac{1}{2}$ m length of wood. How many $\frac{3}{4}$ m length pieces can he cut from it?

6. I need $1\frac{1}{4}$ kg of flour for a recipe. I pour some flour into the weighing scales.
How much more flour do I need for the recipe?

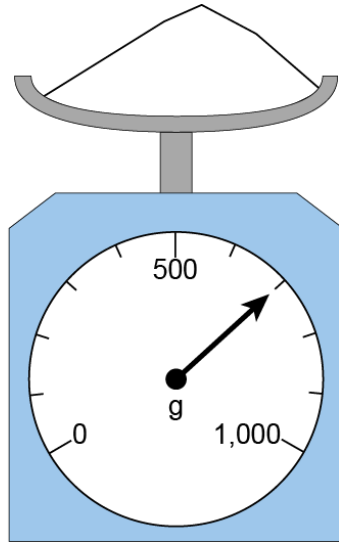

7. Fill in the values in the empty circles so that each row and column of 3 circles adds to 5km.

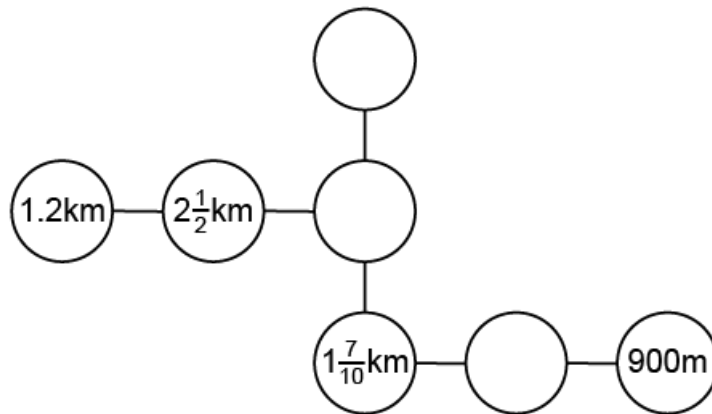

5NF–1 Secure fluency in multiplication and division facts

Secure fluency in multiplication table facts, and corresponding division facts, through continued practice.

5NF–1 Teaching guidance

Before pupils begin work on formal multiplication and division ([5MD–3](#) and [5MD–4](#)), it is essential that pupils have automatic recall of multiplication and division facts within the multiplication tables. These facts are required for calculation within the ‘columns’ during application of formal written methods. All mental multiplicative calculation also depends on these facts.

Identifying core number facts: short multiplication	Identifying core number facts: short division
$\begin{array}{r} 342 \\ \times \quad 7 \\ \hline 2394 \\ \underline{21} \end{array}$ <p>Figure 170: short multiplication of 342 by 7</p>	$\begin{array}{r} 619 \\ 8 \overline{)4,9152} \end{array}$ <p>Figure 171: short division of 4,952 by 8</p>
<p>Within-column calculations:</p> $7 \times 2 = 14$ $7 \times 4 + 1 = 28 + 1$ $7 \times 3 + 2 = 21 + 2$	<p>Within-column calculations:</p> $4 \div 8 = 0 \text{ r } 4$ $49 \div 8 = 6 \text{ r } 1$ $15 \div 8 = 1 \text{ r } 7$ $72 \div 8 = 9$

Pupils should already have automatic recall of multiplication table facts and corresponding division facts, from year 3 (5, 10, 2, 4 and 8 multiplication tables, [3NF–2](#)) and year 4 (all multiplication tables up to and including 12, [4NF–1](#)). Pupils’ fluency in multiplication facts is assessed in the summer term of year 4 in the statutory multiplication tables check, and this will identify some pupils who need additional practice. However, even pupils who were fluent in the multiplication tables at the time of the multiplication tables check will benefit from further practice to maintain and secure fluency. Pupils must also be able to fluently derive related division facts, including division facts with remainders before they begin to learn formal written methods for multiplication and division ([5MD–3](#) and [5MD–4](#)).

The multiplication facts to 9×9 , and related division facts, are particularly important as these are the facts required for formal written multiplication and division. The 36 multiplication facts that are required for formal written multiplication are as follows.

$2 \times 2 = 4$								
$3 \times 2 = 6$	$3 \times 3 = 9$							
$4 \times 2 = 8$	$4 \times 3 = 12$	$4 \times 4 = 16$						
$5 \times 2 = 10$	$5 \times 3 = 15$	$5 \times 4 = 20$	$5 \times 5 = 25$					
$6 \times 2 = 12$	$6 \times 3 = 18$	$6 \times 4 = 24$	$6 \times 5 = 30$	$6 \times 6 = 36$				
$7 \times 2 = 14$	$7 \times 3 = 21$	$7 \times 4 = 28$	$7 \times 5 = 35$	$7 \times 6 = 42$	$7 \times 7 = 49$			
$8 \times 2 = 16$	$8 \times 3 = 24$	$8 \times 4 = 32$	$8 \times 5 = 40$	$8 \times 6 = 48$	$8 \times 7 = 56$	$8 \times 8 = 64$		
$9 \times 2 = 18$	$9 \times 3 = 27$	$9 \times 4 = 36$	$9 \times 5 = 45$	$9 \times 6 = 54$	$9 \times 7 = 63$	$9 \times 8 = 72$	$9 \times 9 = 81$	

You can find out more about multiplicative fluency here in the calculation and fluency section: [5NF-1](#)

Making connections

Fluency in these multiplicative facts is required for:

- mental calculation, when combined with place-value knowledge, for example, if pupils know that $3 \times 4 = 12$, then they can calculate $0.3 \times 4 = 1.2$ and $0.03 \times 4 = 0.12$ ([5NF-2](#))
- identifying factors and multiples ([5MD-1](#))
- within-column calculation in short multiplication ([5MD-3](#)) and short division ([5MD-4](#))
- calculating fractions of quantities ([5F-1](#))
- finding equivalent fractions ([5F-2](#))
- calculating area ([5G-2](#))

5NF-1 Assessment guidance

Assessment for this criterion should focus on whether pupils have fluency in multiplication facts and division facts. Pupils can be assessed through a time-limited written check.

5NF–2 Scaling number facts by 0.1 or 0.01

Apply place-value knowledge to known additive and multiplicative number facts (scaling facts by 1 tenth or 1 hundredth), for example:

$$8 + 6 = 14$$

$$0.8 + 0.6 = 1.4$$

$$0.08 + 0.06 = 0.14$$

$$3 \times 4 = 12$$

$$0.3 \times 4 = 1.2$$

$$0.03 \times 4 = 0.12$$

5NF–2 Teaching guidance

Pupils must be able to combine known additive and multiplicative facts with unitising in tenths and hundredths, including:

- scaling known additive facts within 10, for example, $0.09 - 0.06 = 0.03$
- scaling known additive facts that bridge 10, for example, $0.8 + 0.6 = 1.4$
- scaling known multiplication tables facts, for example $0.03 \times 4 = 0.12$
- scaling division facts derived from multiplication tables, for example, $0.12 \div 4 = 0.03$
- scaling calculation of complements to 100, for example $0.62 + 0.38 = 1$

For calculations such as $0.8 + 0.6 = 1.4$, pupils can begin by using tens frames and counters as they did for calculation across 10 ([2AS–1](#)), calculation across 100 ([3NF–3](#)) and calculation across 1,000 ([4NF–3](#)), but now using 0.1-value counters (or 0.01 value counters for calculations such as $0.08 + 0.06 = 0.14$).

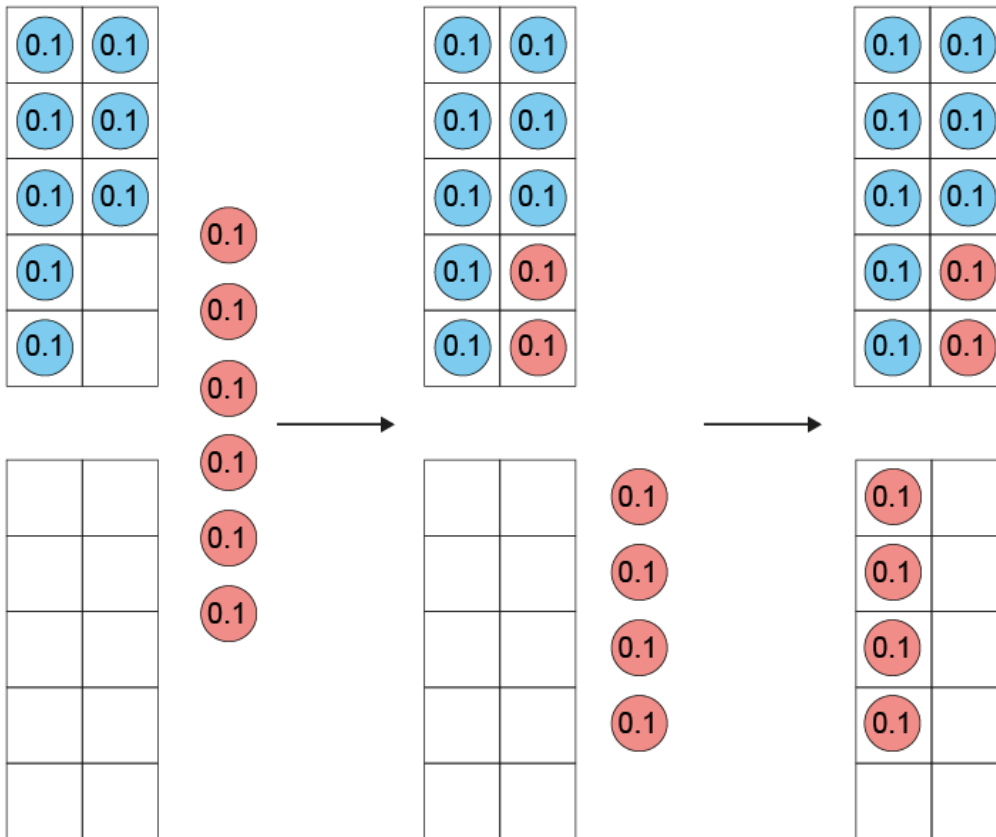

Figure 172: tens frames with 0.1-value counters showing $0.8 + 0.6 = 1.4$

$$8 + 6 = 14$$

$$0.8 + 0.6 = 1.4$$

$$14 - 6 = 8$$

$$1.4 - 0.6 = 0.8$$

$$14 - 8 = 6$$

$$1.4 - 0.8 = 0.6$$

Language focus

“8 plus 6 is equal to 14, so 8 tenths plus 6 tenths is equal to 14 tenths.”

“14 tenths is equal to 1 one and 4 tenths.”

Pupils must also be able to scale additive calculations related to complements to 100 (**3AS-1**), for example:

$$62 + 38 = \boxed{100}$$

so

$$0.62 + 0.38 = \boxed{1}$$

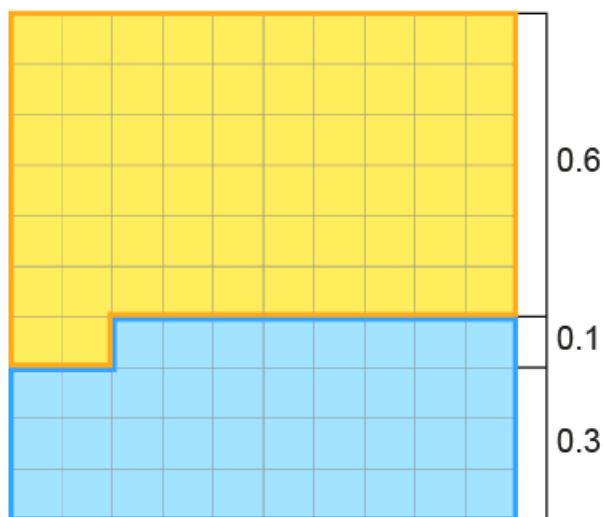

Figure 173: a 100 grid shaded in 2 colours to represent 0.62 and 0.38 as a complement to 1

Pupils can initially use 0.1- or 0.01-value counters to understand how a known multiplicative fact, such as $3 \times 5 = 15$, relates to scaled calculations, such as $3 \times 0.5 = 1.5$ or $3 \times 0.05 = 0.15$. Pupils should be able to reason in terms of unitising in tenths or hundreds, or in terms of scaling a factor by one-tenth or one-hundredth.



Figure 174: 3-by-5 array of 0.01-value place-value counters

$$3 \times 5 = 15$$

$$3 \times 0.05 = 0.15$$

$$3 \times 5 = 15$$

$$0.03 \times 5 = 0.15$$

Language focus

“3 times 5 is equal to 15.”

“3 times 5 hundredths is equal to 15 hundredths.”

“15 hundredths is equal to 0.15.”

Language focus

“3 times 5 is equal to 15.”

“3 hundredths times 5 is equal to 15 hundredths.”

“15 hundredths is equal to 0.15.”

Language focus

“If I make one factor one-hundredth times the size, I must make the product one-hundredth times the size.”

Pupils must be able to make similar connections for known division facts, for example, for scaling by one-hundredth:

$$15 \div 3 = 5$$

$$0.15 \div 0.03 = 5$$

$$0.15 \div 3 = 0.05$$

Language focus

“If I make the dividend one-hundredth times the size and the divisor one-hundredth times the size, the quotient remains the same.”

“If I make the dividend one-hundredth times the size and keep the divisor the same, I must make the quotient one-hundredth times the size.”

It is important for pupils to understand all of the calculations in this criterion in terms of working with units of 0.1 or 0.01, or scaling by one-tenth or one-hundredth for multiplicative calculations.

You can find out more about fluency and recording for these calculations here in the calculation and fluency section: [Number, place value and number facts: 5NPV-2 and 5NF-2](#)

Making connections

This criterion builds on:

- known addition and subtraction facts
- [5NF-1](#), where pupils secure fluency in multiplication and division facts
- [5NPV-1](#), where pupils need to be able to work out how many tenths or hundredths there are in given numbers

Meeting this criterion also requires pupils to be able to fluently divide whole numbers by 10 or 100 ([5MD-1](#)).

5NF–2 Example assessment questions

1. Circle the numbers that sum to 0.13

0.1 0.5 0.05 0.8 0.08 0.3

2. Are these calculations correct? Mark each correct calculation with a tick (✓) and each incorrect calculation with a cross (✗). Explain your answers.

$$0.05 + 0.05 = 0.010$$

$$0.04 + 0.06 = 0.1$$

$$0.13 + 0.7 = 0.2$$

$$0.61 + 0.49 = 1$$

$$0.73 + 0.27 = 1$$

$$0.4 + 0.5 = 0.45$$

3. I live 0.4km away from school. Every day I walk to school in the morning and home again in the afternoon.
- How far do I walk each day?
 - How far do I walk in 5 days?
4. Some children are making bunting for the school fair. If each child makes 0.4m of bunting, and there are 12 children, how many metres of bunting do they make altogether?
5. A chef needs 2.4kg of potatoes for a recipe. If one potato weighs about 0.3kg, approximately how many potatoes does the chef need?
6. A bottle contains 0.7 litres of fruit drink. Maria need 5 litres of drink for a party. How many bottles does she need to buy?
7. I need 0.5kg of brown flour and 0.7kg of white flour for a recipe. What is the total mass of flour that I need?
8. What is the total volume of liquid in these measuring beakers, in litres?

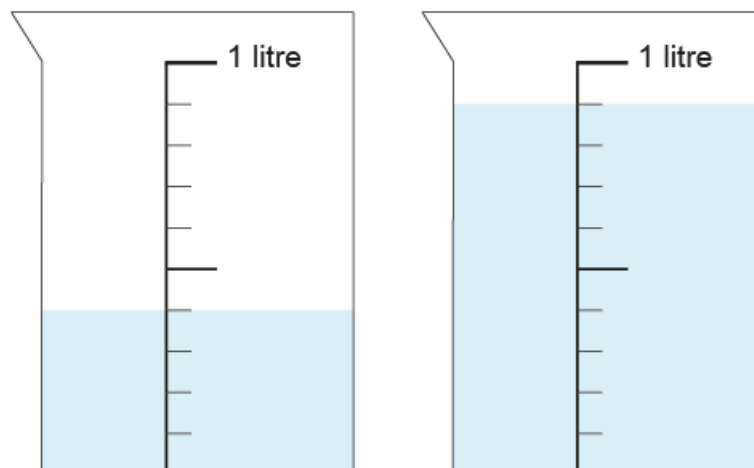

5MD–1 Multiplying and dividing by 10 and 100

Multiply and divide numbers by 10 and 100; understand this as equivalent to making a number 10 or 100 times the size, or 1 tenth or 1 hundredth times the size.

5MD–1 Teaching guidance

In years 3 and 4, pupils considered multiplication and division by 10 and 100 both in terms of scaling (for example, 2,300 is 100 times the size of 23) and in terms of grouping or unitising (for example, 2,300 is 23 groups of 100). To meet criterion **5MD–1**, pupils should be able to use and understand the language of 10 or 100 times the size to describe multiplication of numbers, including decimal fractions, by 10 or 100. They should understand division as the inverse action, and should be able to use and understand the language of one-tenth or one-hundredth times the size to describe division of numbers by 10 or 100, including to calculations that give decimal fraction quotients.

Pupils already know the following relationships between powers of ten, and can describe them using scaling language (“...times the size”).

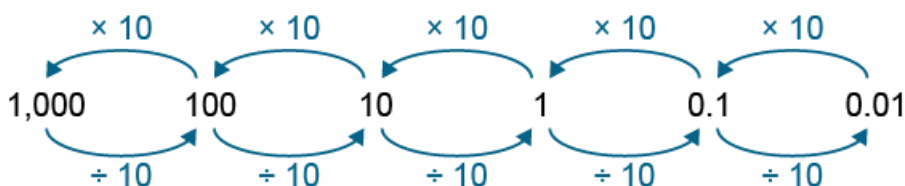

Figure 175: multiplicative relationships between powers of 10: 10 times the size and one-tenth times the size

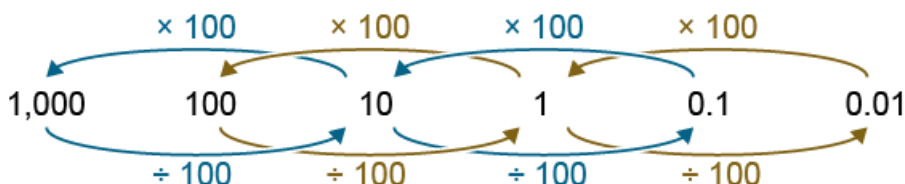

Figure 176: multiplicative relationships between powers of 10: 100 times the size and one-hundredth times the size

Pupils should extend the ‘ten times the size’/‘one-tenth times the size’ relationship to multiplicative calculations that ‘cross’ 1, beginning with those with 1 significant figure. The Gattegno chart can be used to help pupils see, for example, that 8, made one-tenth times the size is 0.8; pupils can move their finger or a counter *down* from 8 to 0.8. Pupils must connect this action to division by 10, and be able to solve/write the corresponding division calculation ($8 \div 10 = 0.8$). Similarly, because 8 is 10 times the size of 0.8, they can solve 0.8×10 , moving their finger or a counter *up* from 0.8 to 8.

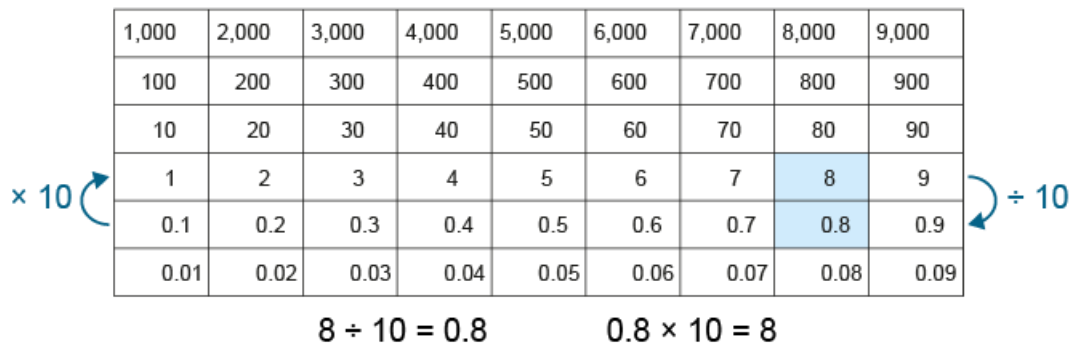

Figure 177: using the Gattegno chart to multiply and divide by 10, crossing 1

Language focus

“8, made one-tenth of the size, is 0.8.”

“8 divided by 10 is equal to 0.8.”

“First we had 8 ones. Now we have 8 tenths.”

“0.8, made 10 times the size, is 8.”

“0.8 multiplied by 10 is equal to 8.”

“First we had 8 tenths. Now we have 8 ones.”

Pupils may also work with place-value charts.

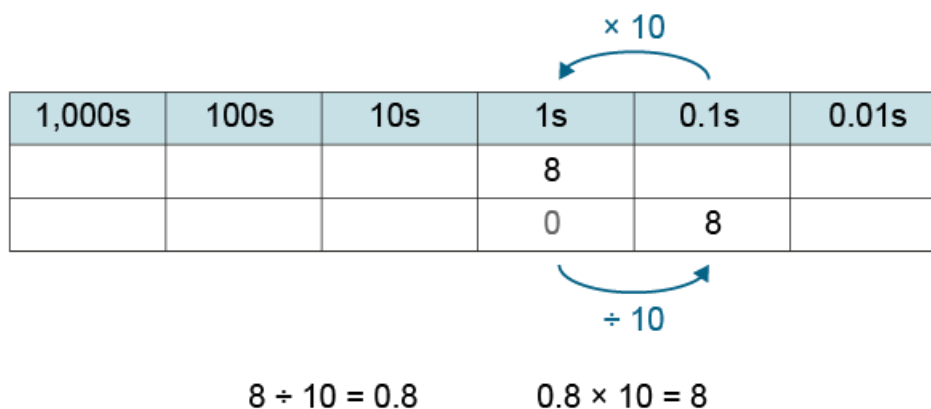

Figure 178: using a place-value chart to multiply and divide by 10, crossing 1

Similarly, pupils should be able to:

- divide ones by 100 and carry out inverse multiplications, for example, $8 \div 100 = 0.08$ and $0.08 \times 100 = 8$

- divide tenths by 10 and carry out inverse multiplications, for example,
 $0.8 \div 10 = 0.08$ and $0.08 \times 10 = 0.8$

This understanding should then be extended to multiplicative calculations that ‘cross’ 1 and involve numbers with *more* than one significant digit, for example:

$$13 \div 100 = 0.13$$

$$0.13 \times 100 = 13$$

$$26.5 \div 10 = 2.65$$

$$2.65 \times 10 = 26.5$$

$$4,710 \div 100 = 47.1$$

$$47.1 \times 100 = 4,710$$

Throughout this criterion, repeated association of the written form (for example, $\div 10$) and the verbal form (for example, “one tenth times the size”) will help pupils become fluent with the links. Pupils should also be able to use appropriate language to describe the relationships in different contexts, including measures.

Language focus

“8cm is 10 times the length of 0.8cm.”

“0.25kg is one-hundredth times the mass of 25kg.”

“150 pencils is 10 times as many as 15 pencils.”

Both the Gattegno chart and place-value charts can be used for support throughout this criterion, but by the end of year 5 pupils must be able to calculate without them. These representations can also help pupils to see that multiplying by 100 is equivalent to multiplying by 10, and then multiplying by 10 again (and that dividing by 100 is equivalent to dividing by 10 and dividing by 10 again).

Making connections

In [5NPV-1](#), pupils learnt to describe the relationship between different powers of 10 in terms of scaling. Here they applied this idea to scale other numbers by 100, 10, one-tenth and one-hundredth.

This criterion also supports scaling known additive and multiplicative number facts by 1 tenth or 1 hundredth. For example, the known fact $5 \times 3 = 15$ can be used to solve 5×0.3 : one factor (3) has been scaled by one tenth, so the product (15) must be scaled by one tenth.

5MD–1 Example assessment questions

1. Fill in the missing numbers.

$$\begin{array}{ccc} & \times 10 & \\ & \rightarrow & \\ \boxed{4.03} & & \boxed{} \\ & \leftarrow & \\ & \div 10 & \end{array}$$

$$\begin{array}{ccc} & \times 10 & \\ & \rightarrow & \\ \boxed{} & & \boxed{0.2} \\ & \leftarrow & \\ & \div 10 & \end{array}$$

$$\begin{array}{ccc} & \times 100 & \\ & \rightarrow & \\ \boxed{21.7} & & \boxed{} \\ & \leftarrow & \\ & \div 100 & \end{array}$$

$$\begin{array}{ccc} & \times 100 & \\ & \rightarrow & \\ \boxed{} & & \boxed{5,806} \\ & \leftarrow & \\ & \div 100 & \end{array}$$

- Ruby ran 2.3km. Her mum ran 10 times this distance. How far did Ruby's mum run?
- A zookeeper weighs an adult gorilla and its baby. The adult gorilla has a mass of 149.3kg. The baby gorilla has a mass one-tenth times that of the adult gorilla. How much does the baby gorilla weigh, in kilograms?
- The length of a new-born crocodile is about 0.25m. The length of an adult female crocodile is about 2.5m. Approximately how many times as long as a new-born crocodile is an adult female crocodile?

5. Fill in the missing numbers.

$$\boxed{} \times 100 = 5$$

$$273 = \boxed{} \times 100$$

$$\boxed{} \times 10 = 6$$

$$42 = \boxed{} \times 10$$

$$\boxed{} \div 100 = 0.79$$

$$1.35 = \boxed{} \div 100$$

$$\boxed{} \div 10 = 0.75$$

$$16.2 = \boxed{} \div 10$$

6. Use the following to complete the equations:

$\times 10$

$\times 100$

$\div 10$

$\div 100$

Use each term only once.

$$543 \boxed{} = 5.43$$

$$0.12 \boxed{} = 1.2$$

$$51.5 \boxed{} = 5,150$$

$$40.3 \boxed{} = 4.03$$

5MD–2 Find factors and multiples

Find factors and multiples of positive whole numbers, including common factors and common multiples, and express a given number as a product of 2 or 3 factors.

5MD–2 Teaching guidance

Pupils should already know and be able to use the words ‘multiple’ and ‘factor’ in the context of the multiplication tables. They should know, for example, that the products within the 6 multiplication table are all multiples of 6, and should be familiar with the generalisation: $\text{factor} \times \text{factor} = \text{product}$

In year 5, pupils should learn the definitions of the terms ‘multiple’ and ‘factor’, and understand the inverse relationship between them.

Language focus

“A multiple of a given number is the product of the given number and any whole number.”

“A factor of a given number is a whole number that the given number can be divided by without giving a remainder.”

“21 is a multiple of 3. 3 is a factor of 21.”

Pupils must be able to identify factors and multiples within the multiplication tables, and should learn to work systematically to identify all of the factors of a given number. They should be able to express products in the multiplication tables as products of 3 factors, where relevant, for example, $48 = 2 \times 3 \times 8$.

Pupils already know how to scale known multiplication table facts by 10 or 100 ([3NF–3](#) and [4NF–3](#)), and must now learn to apply this to identify factors and multiples of larger numbers, as exemplified below.

$$7 \times 3 = 21$$

$$7 \times 300 = 2,100$$

$$700 \times 3 = 2,100$$

Language focus

“21 is a multiple of 3, so...

- 2,100 is a multiple of 300”
- 2,100 is a multiple of 3”

Pupils should learn to express multiples of 10 or 100 as products of 3 factors, for example:

$$7 \times 3 = 21$$

so

$$7 \times 3 \times 10 = 210$$

Pupils should learn that these factors can be written in any order (commutative property of multiplication) and that any pair of the factors can be multiplied together first (associative property of multiplication).

Applying commutativity		Applying associativity (example)
$3 \times 7 \times 10 = 210$	$3 \times 10 \times 7 = 210$	$3 \times 7 \times 10 = 210$
$7 \times 3 \times 10 = 210$	$7 \times 10 \times 3 = 210$	$(3 \times 7) \times 10 = 21 \times 10 = 210$
$10 \times 3 \times 7 = 210$	$10 \times 7 \times 3 = 210$	$3 \times (7 \times 10) = 3 \times 70 = 210$

Pupils should be able to recognise whether any given number is a multiple of 2, 5, or 10 by attending to the final digit and, conversely, recognise 2, 5, or 10 as factors.

Pupils should also be able to recognise multiples and factors linked to their experience of dividing powers of 10 into 2, 4 or 5 equal parts, by attending to the appropriate digit(s), for example:

- 175 is a multiple of 25 (attending to the final 2 digits) 25 is a factor of 175
- 8,500 is a multiple of 500 (attending to the final 3 digits) 500 is factor of 8,500
- 380 is a multiple of 20 (attending to the final 2 digits) 20 is a factor of 380

Pupils should learn to identify factors and multiples for situations other than those described above by using short division or divisibility rules. For example, to determine whether 392 is a multiple of 8 (or whether 8 is a factor of 392) pupils can use the divisibility rule for 8 or use short division to determine whether $392 \div 8$ results in a quotient without a remainder.

Pupils must learn how to find common factors and common multiples of small numbers in preparation for simplifying fractions and finding common denominators. They must also learn to recognise and use squared numbers and use the correct notation (for example, $3^2 = 9$), and learn to establish whether a given number (up to 100) is prime.

Making connections

Pupils must be fluent in their multiplication tables to meet this criterion ([5NF-1](#)), and must also be able to scale multiplication facts by 10 or 100.

Short division ([5MD-4](#)) can be used to identify factors when other strategies are not applicable.

5MD-2 Example assessment questions

1. Write all of the numbers from 1 to 30 in the correct places on this Venn diagram.

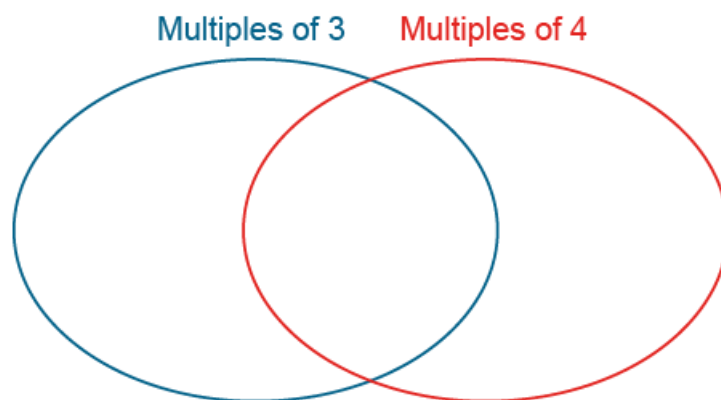

2. Circle any number that is a multiple of both 3 and 7.

42 43 47 49

3. Find a common factor of 48 and 64 that is greater than 6.

4. How many common multiples of 4 and 6 are there that are less than 40?

5. Circle any number that is a factor of both 24 and 36.

2 4 6 8 10 12

6. a. Find a multiple of 30 that is between 200 and 300.

b. Find a multiple of 40 that is between 300 and 400.

c. Find a multiple of 50 that is between 400 and 500.

7. Show that 3 is a factor of 231.

8. Fill in the table with examples of 2-, 3- and 4-digit numbers that are multiples of 9, 25 and 50.

	2-digit number	3-digit number	4-digit number
Multiples of 9			
Multiples of 25			
Multiples of 50			

9. Give two 2-digit factors of 270.
 10. Find 3 numbers which are multiples of 25 but not multiples of 50.
 11. Fill in the missing numbers.

$$6 \times 32 = 6 \times 4 \times \square$$

$$6 \times 5 \times 4 = 5 \times \square$$

$$480 = 8 \times 10 \times \square$$

$$72 = 2 \times 6 \times \square$$

$$\square \times 5 \times \square = 105$$

$$7 \times \square \times \square = 140$$

5MD–3 Multiply using a formal written method

Multiply any whole number with up to 4 digits by any one-digit number using a formal written method.

5MD–3 Teaching guidance

Pupils should learn to multiply multi-digit numbers by one-digit numbers using the formal written method of short multiplication. They should begin with examples that do not involve regrouping, such as the two-digit \times one-digit calculation shown below, and learn that, like columnar addition and subtraction, the algorithm begins with the least significant digit (on the right). When pupils first learn about short multiplication, place-value equipment (such as place-value counters) should be used to model the algorithm and help pupils relate it to what they already know about multiplication. Pupils should understand that short multiplication is based on the distributive property of multiplication which they learnt about in year 4 ([4MD–3](#)).

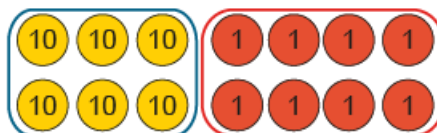

Figure 179: place-value counters showing 34×2

Informal written method	Expanded multiplication algorithm	Short multiplication																														
$34 \times 2 = 30 \times 2 + 4 \times 2$ $= 60 + 8$ $= 68$	<table style="border-collapse: collapse; margin-left: auto; margin-right: auto;"> <tr> <td style="border-right: 1px solid black; padding: 5px;">10s</td> <td style="padding: 5px;">1s</td> <td></td> </tr> <tr> <td style="border-right: 1px solid black; padding: 5px;">3</td> <td style="padding: 5px;">4</td> <td></td> </tr> <tr> <td style="border-right: 1px solid black; padding: 5px;">x</td> <td style="padding: 5px;">2</td> <td></td> </tr> <tr> <td style="border-right: 1px solid black; padding: 5px;"></td> <td style="padding: 5px;">8</td> <td style="padding: 5px;">$2 \times 4 \text{ ones} = 8 \text{ ones}$</td> </tr> <tr> <td style="border-right: 1px solid black; padding: 5px;">6</td> <td style="padding: 5px;">0</td> <td style="padding: 5px;">$2 \times 3 \text{ tens} = 6 \text{ tens}$</td> </tr> <tr> <td style="border-right: 1px solid black; padding: 5px;">6</td> <td style="padding: 5px;">8</td> <td></td> </tr> </table>	10s	1s		3	4		x	2			8	$2 \times 4 \text{ ones} = 8 \text{ ones}$	6	0	$2 \times 3 \text{ tens} = 6 \text{ tens}$	6	8		<table style="border-collapse: collapse; margin-left: auto; margin-right: auto;"> <tr> <td style="border-right: 1px solid black; padding: 5px;">10s</td> <td style="padding: 5px;">1s</td> <td></td> </tr> <tr> <td style="border-right: 1px solid black; padding: 5px;">3</td> <td style="padding: 5px;">4</td> <td></td> </tr> <tr> <td style="border-right: 1px solid black; padding: 5px;">x</td> <td style="padding: 5px;">2</td> <td></td> </tr> <tr> <td style="border-right: 1px solid black; padding: 5px;">6</td> <td style="padding: 5px;">8</td> <td></td> </tr> </table>	10s	1s		3	4		x	2		6	8	
10s	1s																															
3	4																															
x	2																															
	8	$2 \times 4 \text{ ones} = 8 \text{ ones}$																														
6	0	$2 \times 3 \text{ tens} = 6 \text{ tens}$																														
6	8																															
10s	1s																															
3	4																															
x	2																															
6	8																															

Initially, pupils should use unitising language to help them understand and apply short multiplication.

Language focus

“2 times 4 ones is equal to 8 ones: write 8 in the ones column.”

“2 times 3 tens = 6 tens: write 6 in the tens column.”

Pupils may also use place-value headings while they learn to use the formal written method, as illustrated above. However, by the end of year 5, they must be able to use the short multiplication algorithm without using unitising language and place-value headings.

Once pupils have mastered the basic principles of short multiplication without regrouping, they must learn to use the algorithm where regrouping is required, for multiplication of numbers with up to 4 digits by one-digit numbers. Pupils can again use unitising language, now for support with regrouping, until they are able to apply the algorithm fluently.

$$\begin{array}{r}
 367 \\
 \times \quad 4 \\
 \hline
 1,468 \\
 \underline{22} \\
 \hline
 \end{array}$$

Figure 180: multiplying 367 by 4 using short multiplication

$$\begin{array}{ll}
 4 \times 7 \text{ ones} & = 28 \text{ ones} \\
 & = 2 \text{ tens} + 8 \text{ ones} \\
 4 \times 6 \text{ tens} & = 24 \text{ tens} \\
 & = 2 \text{ hundreds} + 4 \text{ tens} \\
 \text{plus 2 more tens} & = 2 \text{ hundreds} + 6 \text{ tens} \\
 4 \times 3 \text{ hundreds} & = 12 \text{ hundreds} \\
 & = 1 \text{ thousand} + 2 \text{ hundreds} \\
 \text{plus 2 more} & \\
 \text{hundreds} & = 1 \text{ thousand} + 4 \text{ hundreds}
 \end{array}$$

Pupils must be able to use short multiplication to solve contextual multiplication problems with:

- the grouping structure (see [5MD-3 5MD-3](#), questions 3 to 6)
- the scaling structure (see **5MD-3 Example assessment questions**, questions 7 and 8)
- Pupils should also be able to use short multiplication to solve missing-dividend problems (for example, $? \div 2,854 = 3$)

Pupils must learn that, although short multiplication can be used to multiply any number by a one-digit number, it is not always the most appropriate choice. For example, 201×4 can be calculated mentally by applying the distributive property of multiplication ($200 \times 4 = 800$, plus 4 more).

You can find out more about recording and fluency for these calculations here in the calculation and fluency section: [5MD-3](#)

Making connections

Pupils must be fluent in multiplication facts within the multiplication tables ([5NF-1](#)) before they begin this criterion. Once pupils have learnt short division ([5MD-4](#)) they should be able to use short multiplication to check their short division calculations, and vice versa.

Pupils should be able to use short multiplication, where appropriate, when calculating a non-unit-fraction of a quantity ([5F-1](#)).

5MD-3 Example assessment questions

1. Fill in the missing numbers.

$$278 \times 6 = \square$$

$$\square = 7 \times 1,297$$

$$\square \div 2,854 = 3$$

$$\square \div 6 = 372$$

2. Draw a line to match each multiplication expression with the correct addition expression.

$$\boxed{48 \times 3}$$

$$\boxed{120 + 18}$$

$$\boxed{6 \times 23}$$

$$\boxed{80 + 4}$$

$$\boxed{26 \times 4}$$

$$\boxed{120 + 24}$$

3. Josh cycles 255 metres in 1 minute. If he keeps cycling at the same speed, how far will he cycle in 8 minutes?
4. A factory packs biscuits into boxes of 9. The factory produces 1,350 packets of biscuits in a day. How many biscuits is that?
5. Ellen has 1 large bag of 96 marbles, and 4 smaller bags each containing 76 marbles. How many marbles does she have altogether?
6. There are 6 eggs in a box. If a farmer needs to deliver 1,275 boxes of eggs to a supermarket, how many eggs does she need?
7. Aryan's grandmother lives 235 kilometres away from Aryan. His aunt lives 3 times that distance away from Aryan. How far away does Aryan's aunt live from him? How far is this to the nearest 100 kilometres?
8. Felicity can make 5 hairbands in 1 hour. A factory can make 235 times as many. How many hairbands can the factory make in 1 hour?
9. Fill in the missing numbers.

$$\begin{array}{r} \square 16 \\ \times \quad \square \\ \hline 2,864 \\ \hline 2 \end{array}$$

$$\begin{array}{r} \square 5 \square 7 \\ \times \quad 4 \\ \hline 6,108 \\ \hline 2 \ 1 \ 2 \end{array}$$

10. Liyana writes:

$$9,565 \div 7 = 1,365$$

Use short multiplication to check whether Liyana's equation is correct.

Assessment guidance: Pupils need to be able to identify when multiplication is the appropriate operation to use to solve a given problem. Assessment of whether a pupil has mastered multiplication sufficiently to progress to year 6 should also include questions which require other operations to solve.

5MD–4 Divide using a formal written method

Divide a number with up to 4 digits by a one-digit number using a formal written method, and interpret remainders appropriately for the context.

5MD–4 Teaching guidance

Pupils should learn to divide multi-digit numbers by one-digit numbers using the formal written method of short division. They should begin with examples that do not involve exchange, such as the two-digit ÷ one-digit calculation shown below. Pupils should learn that division is the only operation for which the formal algorithm begins with the most significant digit (on the left). When pupils first learn about short division, place-value equipment (such as place-value counters) should be used to model the algorithm and help pupils relate it to what they already know about division. They should understand that short division is based on the distributive property of multiplication which they learnt about in year 4 ([4MD–3](#)).

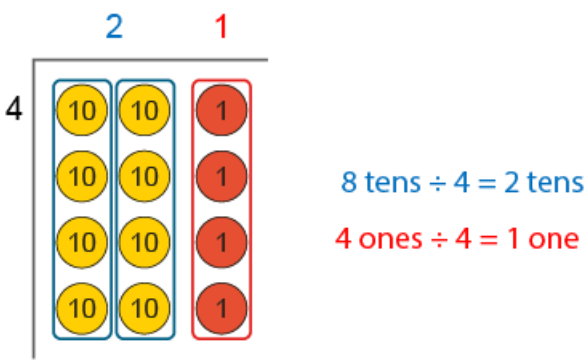
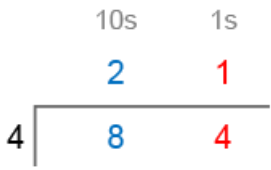
Short division with place-value counters	Short division
 <p data-bbox="215 1456 726 1534">Figure 181: dividing 84 by 4 using short division with place-value counters</p>	 <p data-bbox="853 1456 1364 1534">Figure 182: dividing 84 by 4 using short division with place-value headings</p>

Initially, pupils should use unitising language to help them understand and apply short division.

Language focus

“8 tens divided by 4 is equal to 2 tens: write 2 in the tens column.”

“4 ones divided by 4 is equal to 1 one: write 1 in the ones column.”

Pupils may also use place-value headings while they learn to use the formal written method, as illustrated above. However, by the end of year 5, pupils must be able to use the short division algorithm without using unitising language and place-value headings.

Once pupils have mastered the basic principles of short division without exchange, they must learn to use the algorithm where exchange is required, for division of numbers with up to 4 digits by one-digit numbers. Pupils can again use unitising language, now for support with exchange, until they are able to apply the algorithm fluently.

$$\begin{array}{r} 153 \\ 4 \overline{) 612} \end{array}$$

Figure 183: dividing 612 by 4 using short division

6 hundreds ÷ 4	= 1 hundred remainder 2 hundreds
2 hundreds	= 20 tens
plus 1 more ten	= 21 tens
21 tens ÷ 4	= 5 tens remainder 1 ten
1 ten	= 10 ones
plus 2 more ones	= 12 ones
12 ones ÷ 4	= 3 ones

Pupils must be able to use short division to solve contextual division problems with:

- the quotitive structure (see [5MD-4 Example assessment questions](#), questions 5 and 8)
- the partitive structure (see [5MD-4 Example assessment questions](#), questions 2, 6 and 7)

Pupils should also be able to use short division to find unit fractions of quantities, and to solve missing-factor problems (for example, $? \times 5 = 1,325$) and missing-divisor problems (for example, $952 \div ? = 7$).

Pupils must be able to carry out short division calculations that involve a remainder and, for contextual problems, interpret the remainder appropriately as they learnt to do in year 4 ([4NF-2](#)).

Pupils must learn that, although short division can be used to divide any number by a one-digit number, it is not always the most appropriate choice. For example, $804 \div 4$, can be calculated mentally by partitioning, dividing and adding the partial quotients ($804 \div 4 = 200$, plus 1 more).

You can find out more about recording and fluency for these calculations here in the calculation and fluency section: [5MD-4](#)

Making connections

Pupils must be fluent in division facts corresponding to the multiplication tables (**5NF-1**) before they begin this criterion. Pupils should be able to use short multiplication (**5MD-3**) to check their short division calculations, and vice versa. Pupils should be able to use short division, where appropriate, to find a unit fraction of a quantity, and as the first step in finding a non-unit fraction of a quantity (**5F-1**).

5MD-4 Example assessment questions

1. Fill in the missing numbers.

$$4,728 \div 8 = \square$$

$$952 \div \square = 7$$

$$\square \times 5 = 1,325$$

$$176 = 4 \times \square$$

2. I have $1\frac{1}{2}$ litres of juice which I need to share equally between 6 glasses. How many millilitres of juice should I pour into each glass?
3. A school fair raises £5,164. The school keeps $\frac{1}{4}$ of the money for new playground equipment and gives the rest to charity. How much money does the school keep?
4. Fryderyk has saved 4 times as much money as his sister Gabriel. If Fryderyk has saved £348, how much has Gabriel saved?
5. A farmer has 3,150 eggs to pack into boxes of 6. How many boxes does she need?
6. Sharif wants to walk a long distance, for charity, over 6 weekends. The total distance Sharif wants to walk is 293km. Approximately how far should he walk each weekend?
7. Maria makes 1,531g of cake mix. She puts 250g into a small cake tin and wants to share the rest equally between 3 large cake tins. How many grams of cake mix should she put in each large cake tin?
8. 174 children are going on a trip. 4 children can fit into each room in the hostel. How many rooms are needed?
9. Fill in the missing numbers.

$$\begin{array}{r} \\ \square \overline{) 2,7215} \end{array}$$

$$\begin{array}{r} \\ 7 \overline{) 1,\square1256} \end{array}$$

10. David writes:

$$785 \times 9 = 7,065$$

Use short division to check whether David's calculation is correct.

Assessment guidance: Pupils need to be able to identify when division is the appropriate operation to use to solve a given problem. Assessment of whether a pupil has mastered division sufficiently to progress to year 6 should also include questions which require other operations to solve.

5F–1 Find non-unit fractions of quantities

Find non-unit fractions of quantities.

5F–1 Teaching guidance

Pupils should already be able to find unit fractions of quantities using known division facts corresponding to multiplication table facts ([3F–2](#)).

Language focus

“To find $\frac{1}{5}$ of 15, we divide 15 into 5 equal parts.”

“15 divided by 5 is equal to 3, so $\frac{1}{5}$ of 15 is equal to 3.”

By the end of year 5 pupils must be able to find unit and non-unit fractions of quantities, including for situations that go beyond known multiplication and division facts.

Pupils already understand the connection between a unit fraction of a quantity and dividing that quantity by the denominator. Now they should learn to reason about finding a non-unit fraction of a quantity, using division (to find the unit fraction) then multiplication (to find multiples of the unit fraction), and link this to their understanding of parts and wholes. Initially, calculations should depend upon known multiplication and division facts, so that pupils can focus on reasoning.

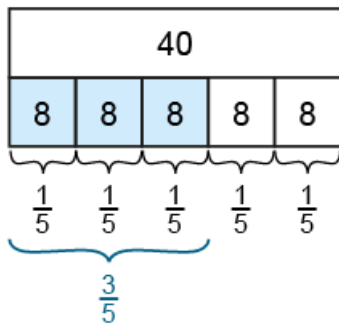

Figure 184: bar model to support finding three-fifths of 40

$$40 \div 5 = 8$$

$$\text{So, } \frac{1}{5} \text{ of } 40 = 8$$

$$8 \times 3 = 24$$

$$\text{So, } \frac{3}{5} \text{ of } 40 = 24$$

Language focus

“Three-fifths is equal to 3 one-fifths.”

“To find 3 one-fifths of 40, first find one-fifth of 40 by dividing by 5, and then multiply by 3.”

Once pupils can carry out these calculations fluently, and explain their reasoning, they should extend their understanding to calculate unit and non-unit fractions of quantities for calculations that go beyond known multiplication table facts. For example, they should be able to:

- apply place-value understanding to known number facts to find $\frac{3}{7}$ of 210
- use short division followed by short multiplication to find $\frac{4}{9}$ of 3,411

Pupils should also be able to construct their own bar models to solve more complex problems related to fractions of quantities. For example:

Miss Reeves has some tangerines to give out during break-time. She has given out $\frac{5}{6}$ of the tangerines, and has 30 left. How many tangerines did Miss Reeves have to begin with?

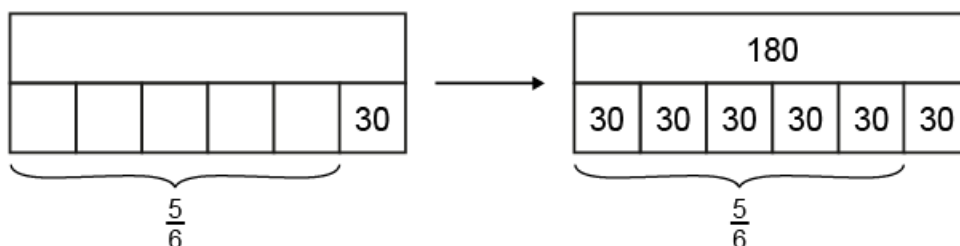

Figure 185: using a bar model to solve more complex problems related to fractions of quantities

Making connections

Pupils must be fluent in multiplication facts within the multiplication tables, and corresponding division facts (**5NF-1**). They must be able to confidently scale these facts by 10 or 100 (**3NF-3** and **4NF-3**) to find, for example, $\frac{3}{7}$ of 210. Pupils also need to be able to calculate using short multiplication (**5MD-3**) and short division (**5MD-4**) to be able to find, for example, $\frac{4}{9}$ of 3,411.

5F-1 Example assessment questions

1. Find:

$\frac{3}{8}$ of 32

$\frac{2}{9}$ of 45

$\frac{3}{5}$ of 30

$\frac{2}{7}$ of 630

$\frac{4}{9}$ of 315

$\frac{2}{5}$ of 3,500

$\frac{5}{8}$ of 2,720

- Stan bought 15 litres of paint and used $\frac{2}{3}$ of it decorating his house. How much paint has he used?
- My granny lives 120km from us. We are driving to see her and are $\frac{5}{6}$ of the way there. How far have we driven so far?
- I am $\frac{3}{4}$ of the way through my holiday. I have 3 days of holiday left. How many days have I already been on holiday for?
- A school is trying to raise £7,500 for charity. They have raised $\frac{5}{6}$ of the total so far. How much have they raised?
- $\frac{4}{5}$ of the runners in a race have finished the race so far. If 92 people have finished, how many runners were in the race altogether?
- There are 315 cows on a farm. $\frac{3}{5}$ of the cows are having calves this year. How many cows are not having calves?

5F–2 Find equivalent fractions

Find equivalent fractions and understand that they have the same value and the same position in the linear number system.

5F–2 Teaching guidance

Pupils must understand that more than one fraction can describe the same portion of a quantity, shape or measure. They should begin with an example where one of the fractions is a unit fraction, and the connection to the equivalent fraction uses known multiplication table facts.

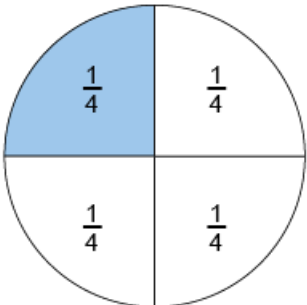
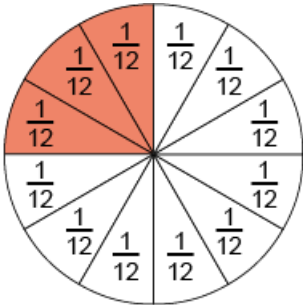
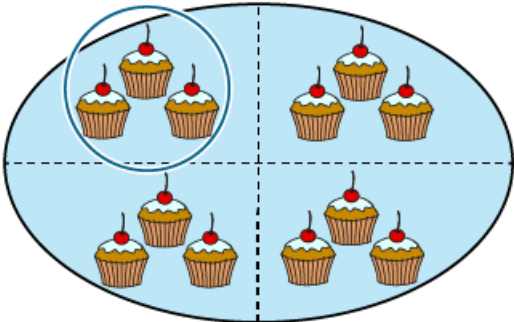
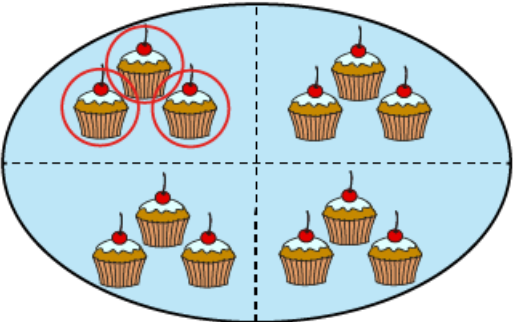
$\frac{1}{4}$	$\frac{3}{12}$
	
<p>Figure 186: circle divided into 4 equal parts with 1 part shaded</p>	<p>Figure 187: circle divided into 12 equal parts with 3 parts shaded</p>
<p>Language focus</p> <p>“The whole is divided into 4 equal parts and 1 of those parts is shaded.”</p>	<p>Language focus</p> <p>“The whole is divided into 12 equal parts and 3 of those parts is shaded.”</p>
	
<p>Figure 188: diagram showing that $\frac{1}{4}$ of 12 cakes is equal to 3 cakes</p>	<p>Figure 189: diagram showing that $\frac{3}{12}$ of 12 cakes is equal to 3 cakes</p>

$$\frac{1}{4} = \frac{3}{12}$$

Pupils should learn that 2 different fractions describing the same portion of the whole share the same position on a number line, have the same numerical value and are called equivalent fractions.

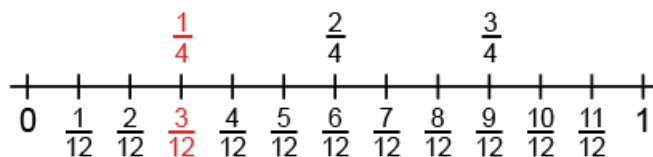

Figure 190: number line showing that $\frac{1}{4}$ and $\frac{3}{12}$ are equivalent

Pupils need to understand that equivalent fractions, such as $\frac{1}{4}$ and $\frac{3}{12}$, have the same numerical value because the numerator and denominator within each fraction have the same proportional relationship. In each case the numerator is $\frac{1}{4}$ of the denominator (and the denominator is 4 times the numerator).

Language focus

“ $\frac{1}{4}$ and $\frac{3}{12}$ are equivalent because 1 is the same portion of 4 as 3 is of 12.”

Attending to the relationship between the numerator and denominator will prepare pupils for comparing fractions with different denominators in year 6 (**6F-3**). Pupils should also be able to identify the multiplicative relationship between the pair of numerators, and understand that it is the same as that between the pair of denominators.

Pupils should learn to find equivalent fractions of unit fractions by using one of these multiplicative relationships (the ‘vertical’ relationship between the numerator and denominator, or the ‘horizontal’ relationship between the pairs of numerators and denominators).

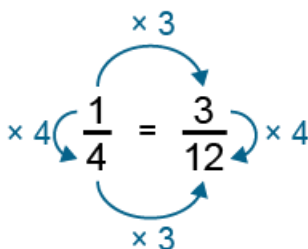

Figure 191: diagram showing the multiplicative relationships between the numerators and denominators in $\frac{1}{4}$ and $\frac{3}{12}$

In a similar way, pupils must then learn to find equivalent fractions of non-unit fractions,

for example, $\frac{3}{5} = \frac{6}{10}$ or $\frac{3}{12} = \frac{8}{32}$.

Making connections

Pupils must be fluent in multiplication facts within the multiplication tables, and corresponding division facts (**5NF-1**). Being able to find unit and non-unit fractions of a quantity (**5F-1**) helps pupils to see that equivalent fractions have the same value.

5F-2 Example assessment questions

- Find different ways to write the fraction of each shape or quantity that is shaded or highlighted.

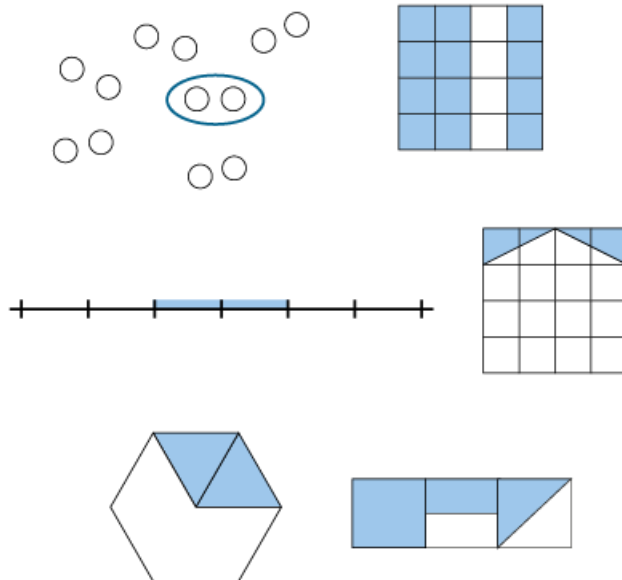

- Draw lines to match the unit fractions on the left with their equivalent fractions on the right.

$$\frac{1}{5}$$

$$\frac{3}{12}$$

$$\frac{1}{4}$$

$$\frac{4}{20}$$

$$\frac{1}{3}$$

$$\frac{3}{9}$$

3. Mark each fraction on the number line.

$$\frac{9}{24} \quad \frac{36}{48} \quad \frac{12}{16} \quad \frac{10}{40} \quad \frac{9}{72}$$

Hint: convert each fraction to an equivalent fraction with a denominator of 8.

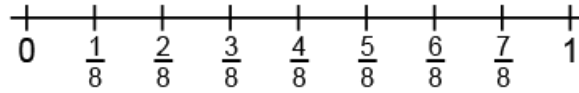

4. Use the numbers 3, 24, 8 and 1 to complete this chain of equivalent fractions.

$$\frac{2}{6} = \frac{\square}{\square} = \frac{\square}{\square}$$

5. Fill in the missing digits.

$$\frac{4}{8} = \frac{12}{\square}$$

$$\frac{3}{5} = \frac{\square}{40}$$

$$\frac{3}{\square} = \frac{21}{63}$$

$$\frac{20}{30} = \frac{\square}{15}$$

6. Fill in the missing number.

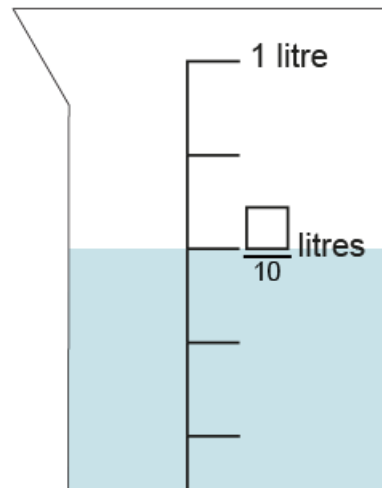
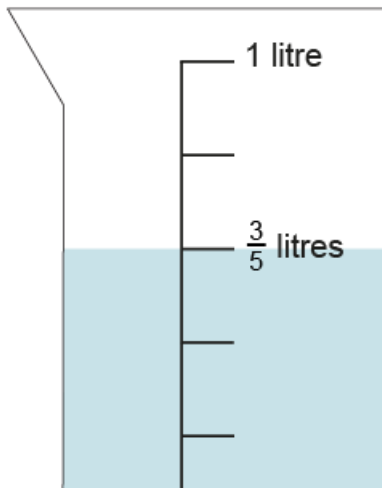

7. Sally and Tahira each have a 1m ribbon.

Sally cuts her ribbon into 5 equal parts and uses 1 of them to make a hair tie.

Tahira cuts her ribbon into 10 equal parts and uses 3 of them to make a bracelet.

Have Sally and Tahira used the same amount of ribbon? Explain your answer.

5F–3 Recall decimal equivalents for common fractions

Recall decimal fraction equivalents for $\frac{1}{2}$, $\frac{1}{4}$, $\frac{1}{5}$ and $\frac{1}{10}$, and for multiples of these proper fractions.

5F–3 Teaching guidance

Pupils know that both proper fractions and decimal fractions can be used to represent values between whole numbers. They now need to learn that the same value can be represented by both a decimal fraction and a proper fraction, and be able to recall common equivalents, beginning with unit fractions.

Unit fraction	Decimal fraction
$\frac{1}{2}$	0.5
$\frac{1}{4}$	0.25
$\frac{1}{5}$	0.2
$\frac{1}{10}$	0.1

Pupils should also be able to explain the equivalencies. A shaded hundred grid is a useful representation here.

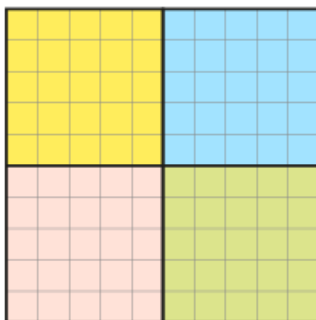

Figure 192: hundred grid divided into 4 equal parts: $\frac{1}{4}$ is equal to 25 hundredths

$$\frac{1}{4} = \frac{25}{100} = 0.25$$

Pupils should then extend their understanding and automatic recall to multiples of these unit fractions/decimal fractions, up to 1.

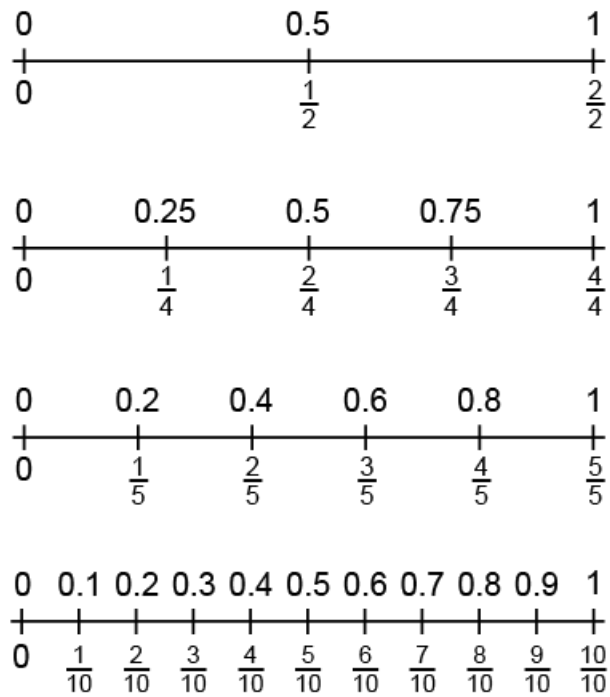

Figure 193: 0 to 1 number lines illustrating common proper fraction – decimal fraction equivalents

Pupils must be able to use these common equivalents with little effort, applying them to solve comparison and measures problems such as those shown in the example assessment questions. For a given problem, posed using a mixture of decimal fractions and proper fractions, pupils should be able to make a sensible decision about whether to carry out the calculation using decimal fractions or proper fractions.

Finally, pupils need to extend this knowledge beyond the 0 to 1 interval. They should know for example that 3.2km and $3\frac{1}{5}$ km are 2 different ways of writing the same distance.

Making connections

This criterion builds on [5NPV-4](#), where pupils learnt to divide 1 into 2, 4, 5 or 10 equal parts and to read scales marked in multiples of multiples of 0.1, 0.2, 0.25 or 0.5.

Criterion [5NPV-5](#) requires pupils to convert between units of measure, including using the common decimal fraction and proper fraction equivalents in this criterion.

5F–3 Example assessment questions

1. Fill in the missing symbols (<, > or =).

$$\frac{1}{10} \bigcirc 0.75$$

$$0.4 \bigcirc \frac{1}{4}$$

$$0.5 \bigcirc \frac{1}{5}$$

$$\frac{3}{4} \bigcirc 0.75$$

$$0.8 \bigcirc \frac{4}{5}$$

$$\frac{1}{2} \bigcirc 0.2$$

2. Write these measurements as mixed numbers.

1.2km

5.75m

25.5kg

3. Write these measurements as decimals.

$1\frac{1}{4}$ litres

$10\frac{1}{2}$ cm

$4\frac{4}{5}$ m

4. My brother weighs 27.3kg. I weigh $27\frac{1}{2}$ kg. How much more than my brother do I weigh?

5. Year 6 set off on a $2\frac{3}{4}$ km woodland walk. By lunch, they had walked 1.75km. How much further do they need to walk?

6. Here are two parcels:

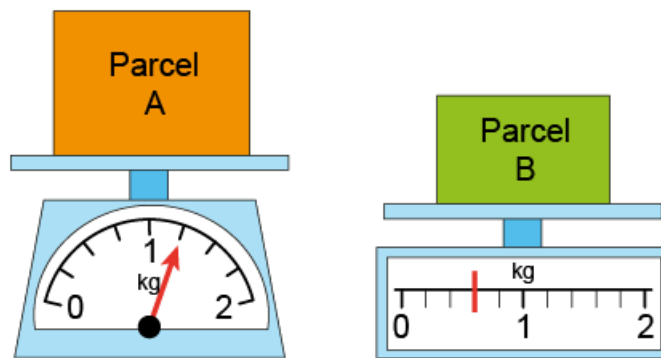

What is the total combined weight of the parcels, in kilograms?

7. Put each set of numbers in order from smallest to greatest.

a. 1.4 $4\frac{1}{4}$ 4.1 4.4

b. $3\frac{1}{5}$ 3.5 $1\frac{3}{5}$ 1.3

5G–1 Compare, estimate, measure and draw angles

Compare angles, estimate and measure angles in degrees ($^{\circ}$) and draw angles of a given size.

5G–1 Teaching guidance

In year 3, pupils learnt to identify right angles and to determine whether a given angle is larger or smaller than a right angle (**3G–1**). Pupils should now compare angles, including the internal angles of polygons, and be able to identify the largest and smallest angles when there is a clear visual difference. Pupils should be able to use the terms acute, obtuse and reflex when describing and comparing angles, and use conventional markings (arcs) to indicate angles.

Language focus

“An acute angle is smaller than a right angle.”

“An obtuse angle is larger than a right angle but less than the angle on a straight line.”

“A reflex angle is larger than the angle on a straight line, but less than the angle for a full turn.”

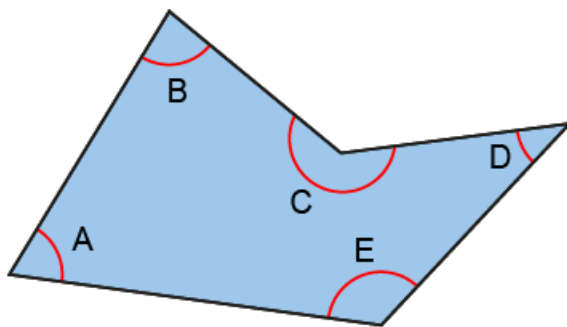

Figure 194: irregular pentagon with 3 acute internal angles, 1 obtuse internal angle and 1 reflex internal angle

Language focus

“D is the smallest angle. It is an acute angle.”

“C is the largest angle. It is a reflex angle.”

Pupils must learn that we can measure the size of angles just as we can measure the length of sides. They should learn that the unit used is called degrees and indicated by the $^{\circ}$ symbol. Pupils should know that there are 360° in a full turn, 90° in a quarter turn or right angle, and 180° in a half turn or on a straight line.

Pupils must know that the position of the arc indicating an angle does not affect the size of the angle, which is determined by the amount of turn between the two lines. Similarly, they should know that the length of the lines does not affect the size of the angle between them.

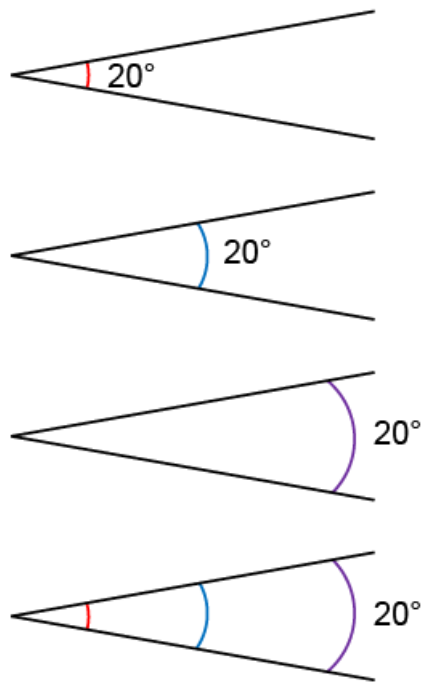

Figure 195: the position of the arc indicating an angle does not affect the size of the angle

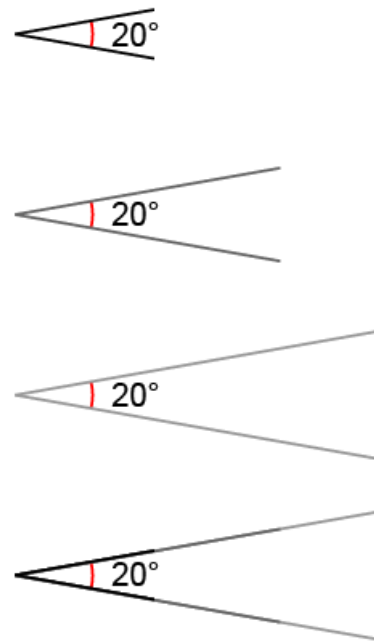

Figure 196: the length of the lines does not affect the size of the angle between them

Before pupils learn to use protractors, they should learn to estimate and approximate common angles, and angles that are close to them, including 90° , 180° , other multiples of 10° , and 45° . They should use sets of 'standard angle' measuring tools (for example, cut out from card) for support in approximating, and to check estimates.

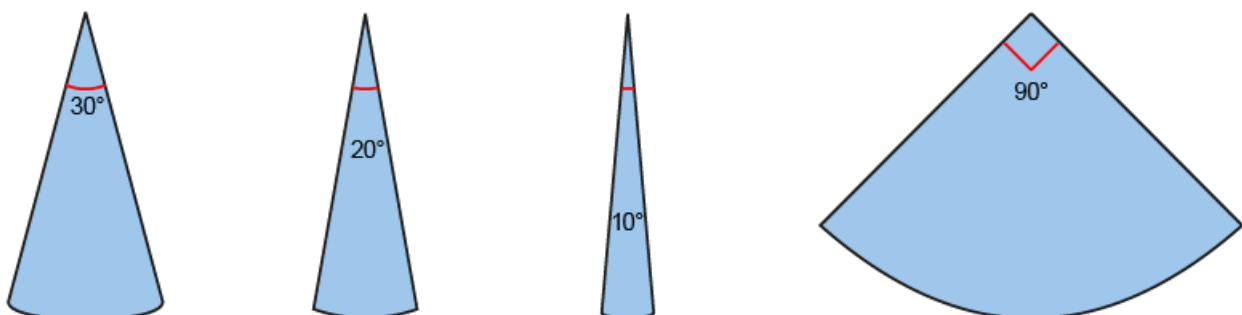

Figure 197: a selection of 'standard angle' measuring tools

Once pupils can make reasonable estimates of angle size, they must learn to make accurate measurements, using a protractor, for angles up to 180° . It is good practice to make an estimate before taking an accurate measurement, and pupils should use learn to use their estimates for support in reading the correct value off the protractor.

Pupils should also, now, be able to use the more formal definitions of acute, obtuse and reflex.

Language focus

“An acute angle is less than 90° .”

“An obtuse angle is greater than 90° but less than 180° .”

“A reflex angle is greater than 180° but less than 360° .”

5G–1 Example assessment questions

Do not use a protractor for questions 1, 2 and 3.

1. Here is an irregular pentagon.

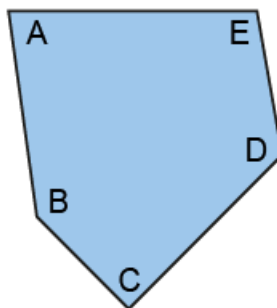

- Which is the largest angle in this pentagon?
- Which is the smallest angle?
- Which angle is 100° ?

2. Here are 6 angles.

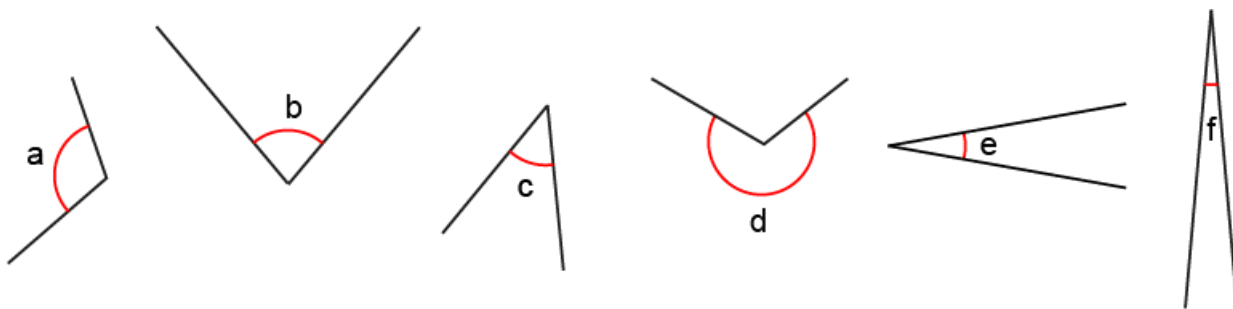

- a. Which is the largest angle?
- b. Which is the smallest angle?
- c. Which angle is 45° ?

3. This pentagon has a line of symmetry. Estimate the size of each angle.

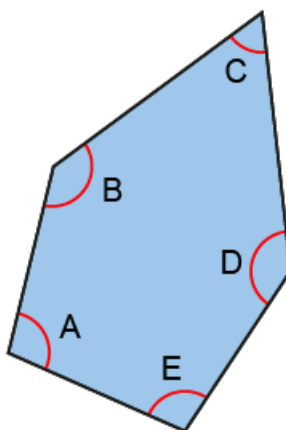

4. Measure and label each of the angles in these shapes using a protractor.

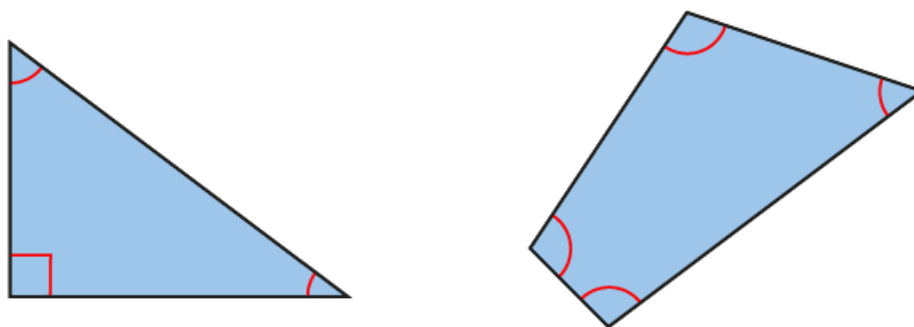

- 5. a. Draw an angle of 68° .
- b. Draw an angle of 103° .

5G–2 Compare and calculate areas

Compare areas and calculate the area of rectangles (including squares) using standard units.

5G–2 Teaching guidance

Pupils need to know that the area of a shape is the space within a shape. When there is a clear visual difference, pupils should be able to compare the area of shapes without making a quantitative evaluation of each area. For example, pupils can see that the circle has a larger area than the decagon.

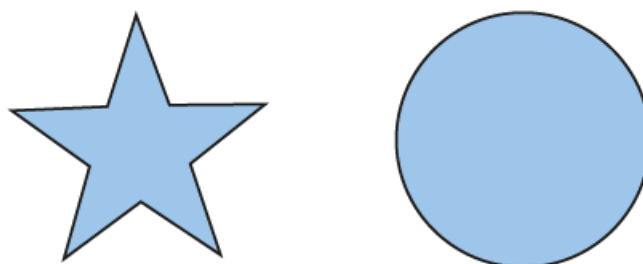

Figure 198: a decagon and a circle with a clear visual difference in area

Pupils should learn that, when there is not a clear visual difference between areas, a common unit can be used to quantify the areas and enable comparison. They should understand that any unit can be used, but that the square centimetre (cm^2) is the standard unit of measure for area that they will use most frequently. Pupils should gain a sense of the size of a square centimetre, and the notation used, before they begin to quantify other areas using this unit.

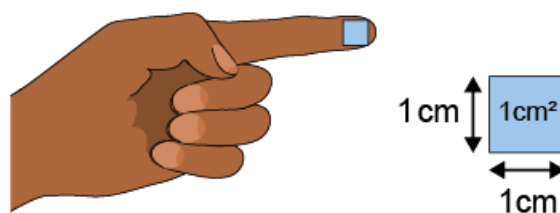

Figure 199: a square centimetre

Pupils need to be able to find the area of shapes drawn on square-centimetre grids by counting squares, including shapes for which some of the area is made up of half-squares. They should understand that different shapes can have the same area.

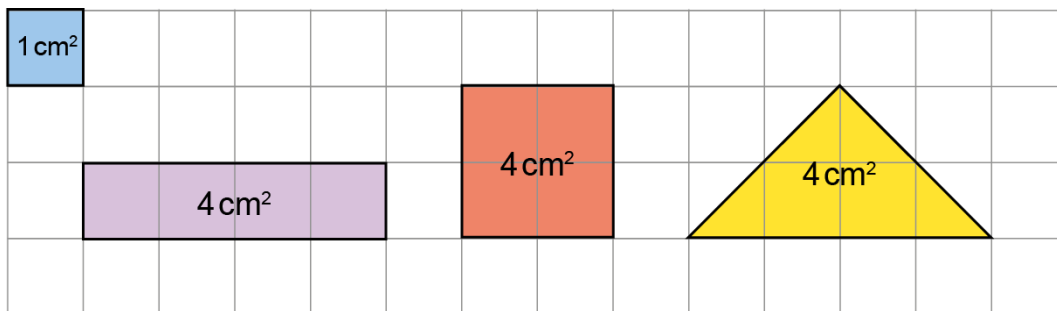

Figure 200: a rectangle, square and triangle with equal areas

Drawn to actual size.

Pupils should then learn that the area of a rectangle can be calculated by multiplying the length by the width. They should learn why this is the case by examining rectangles drawn on square-centimetre grids, and understand that the factors can be written in either order: the area of the rectangle below is equal to 4 rows of 5 square centimetres, or 5 columns of 4 square centimetres. This should build on pupils understanding of the grouping structure of multiplication and array representations.

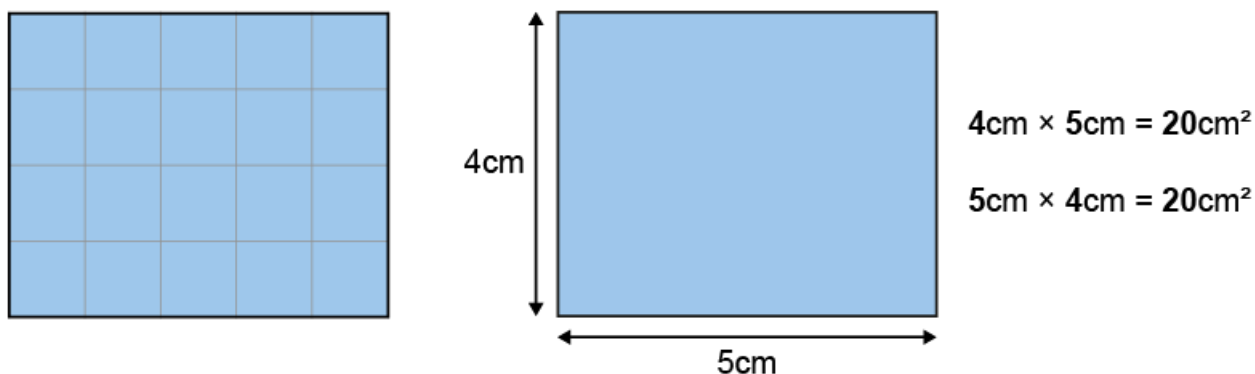

Figure 201: the area of a rectangle can be calculated by multiplying the length by the width

Drawn to actual size.

Language focus

“To find the area of a rectangle, multiply the length by the width.”

Pupils should learn that the area of larger shapes and spaces, such as the floor or ceiling of the classroom, or the playground, is expressed in square metres (m^2). Pupils should experience working with large spaces directly, as well as drawings representing them.

Making connections

Pupils must be able to multiply two numbers together in order to calculate the area of a rectangle, including:

- known multiplication facts within the multiplication tables ([5NF-1](#)) (for example, to calculate the area of a 9cm by 4cm rectangle)
- scaling known multiplication facts by 10 or 100 ([3NF-3](#) , [4NF-3](#) and [5NF-2](#)) (for example, to calculate the area of a 0.2m × 3m rectangle or a 20m × 3m rectangle)
- other mental or written methods (for example, to calculate the area of a 15cm × 8cm rectangle)

5G-2 Example assessment questions

1. For each pair of shapes, tick the shape with the larger shaded area.

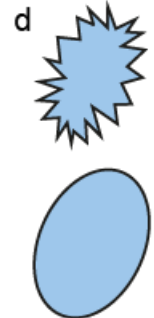
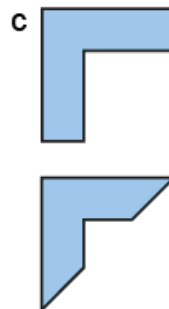
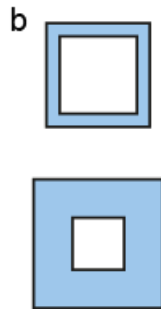
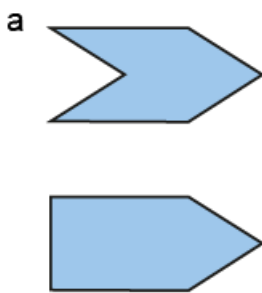

2. Find the area of these shapes drawn on a square-centimetre grid.

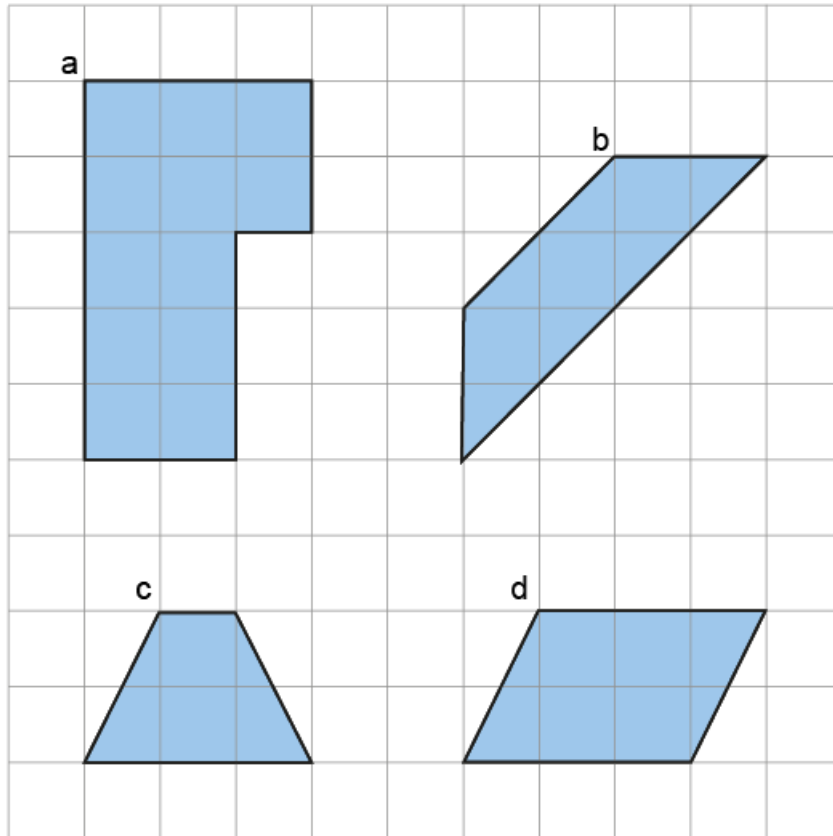

Drawn to actual size.

3. Here are three shapes on a triangular grid. Put the shapes in order from smallest to largest according to their area.

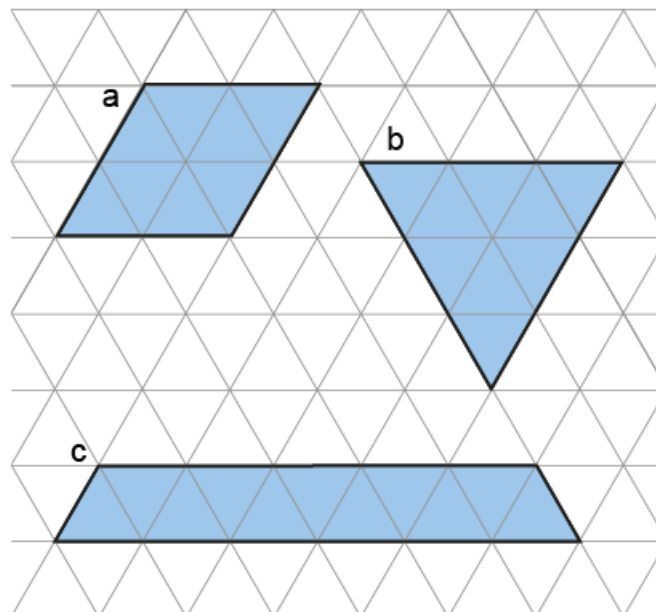

4. a. Draw a rectangle with an area of 12cm^2 on this square-centimetre grid.
 b. Draw a hexagon with an area of 12cm^2 on this square-centimetre grid.

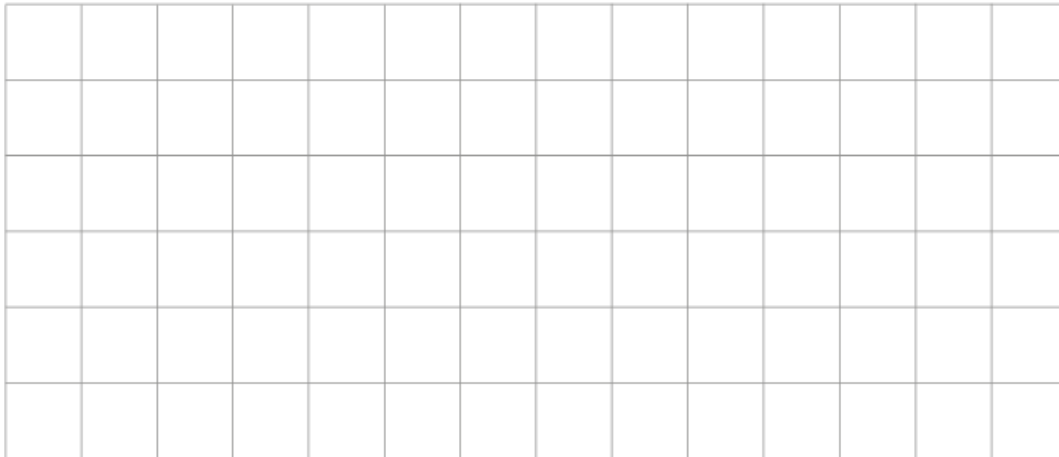

Drawn to actual size.

5. Find the area of each of these rectangles.

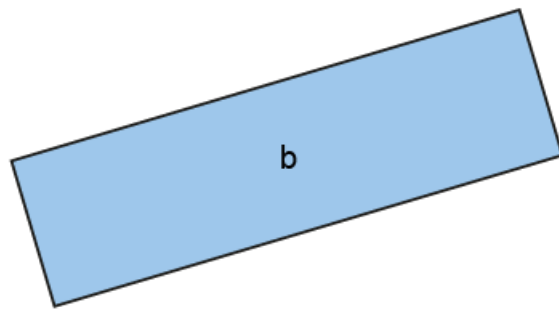
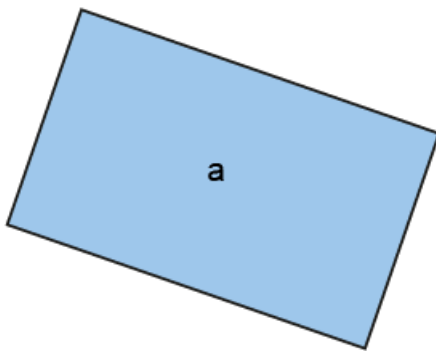

6. Leila is putting some tiles on the wall behind her kitchen sink. Each tile is square, with sides equal to 10cm.

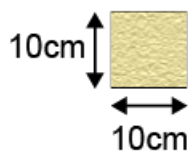

Here is the area she has tiled so far.

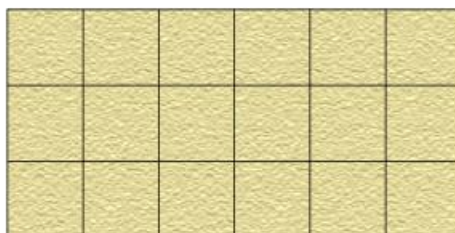

If Leila adds one more row of tiles on top of these ones, what is the total area she will have tiled?

7. Each half of a volleyball court is a $9\text{m} \times 9\text{m}$ square. What is the total area of a volleyball court?

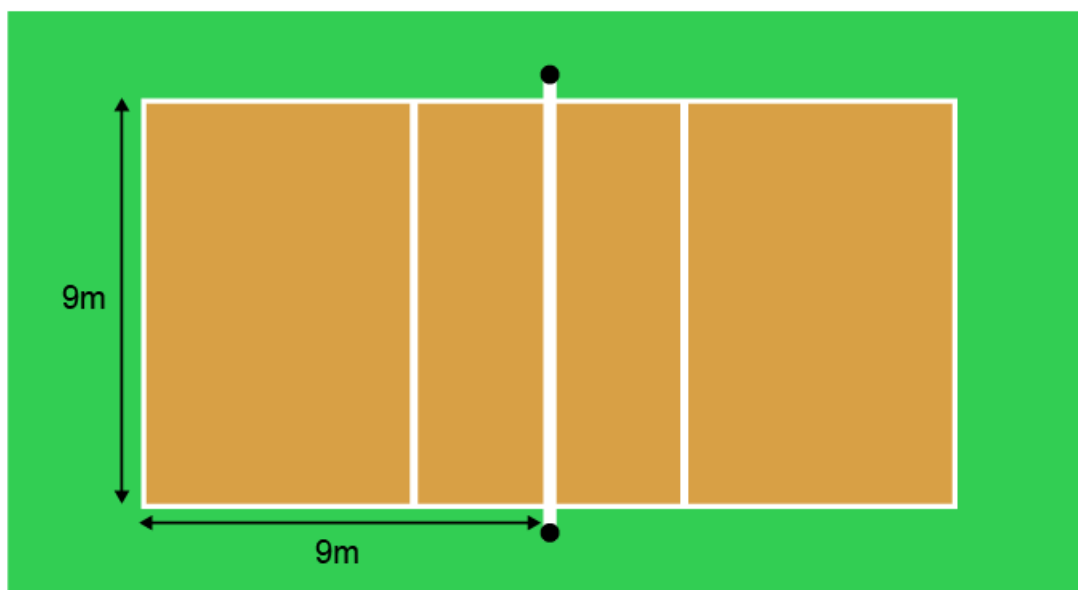

Drawn to scale.

8. Estimate the area of your classroom floor.

Calculation and fluency

Number, place value and number facts: **5NPV-2** and **5NF-2**

- **5NPV-2** Recognise the place value of each digit in numbers with up to 2 decimal places, and compose and decompose numbers with up to 2 decimal places using standard and non-standard partitioning.
- **5NF-2** Apply place-value knowledge to known additive and multiplicative number facts (scaling facts by 1 tenth or 1 hundredth), for example:

$$8 + 6 = 14$$

$$0.8 + 0.6 = 1.4$$

$$0.08 + 0.06 = 0.14$$

$$3 \times 4 = 12$$

$$0.3 \times 4 = 1.2$$

$$0.03 \times 4 = 0.12$$

Representations such as place-value counters and partitioning diagrams (**5NPV-2**) and tens-frames with place-value counters (**5NF-2**) can be used initially to help pupils understand calculation strategies and make connections between known facts and related calculations. However, pupils should not rely on such representations for calculating. For the calculations in **5NF-2**, for example, pupils should instead be able to calculate by verbalising the relationship.

Language focus

“8 plus 6 is equal to 14, so 8 tenths plus 6 tenths is equal to 14 tenths.”

“14 tenths is equal to 1 one and 4 tenths.”

Pupils should maintain fluency in both formal written and mental methods for addition and subtraction. Mental methods can include jottings to keep track of calculation, or language structures as exemplified above. Pupils should select the most efficient method to calculate depending on the numbers involved.

Addition and subtraction: extending 3AS–3

Pupils should also extend columnar addition and subtraction methods to numbers with up to 2 decimal places.

Pupils must be able to add 2 or more numbers using columnar addition, including calculations whose addends have different numbers of digits.

$$\begin{array}{r} 274.1 \\ + 195.8 \\ \hline 469.9 \\ 1 \end{array}$$
$$\begin{array}{r} 47.52 \\ + 81.7 \\ \hline 129.22 \\ 1 \end{array}$$
$$\begin{array}{r} 6.3 \\ 1.49 \\ + 25.6 \\ \hline 33.39 \\ 11 \end{array}$$

Figure 202: columnar addition for calculations involving numbers with up to 2 decimal places

For calculations with more than 2 addends, pupils should add the digits within a column in the most efficient order. For the third example above, efficient choices could include:

- beginning by making 10 in the tenths column
- making double-6 in the ones column

Pupils must be able to subtract one number from another using columnar subtraction, including numbers with up to 2 decimal places. They should be able to apply the columnar method to calculations presented as, for example, $21.8 - 9.29$ or $58 - 14.69$, where the subtrahend has more decimal places than the minuend. Pupils must also be able to exchange through 0.

$$\begin{array}{r}
 21.8 - 9.29 \\
 \begin{array}{r}
 4 \overset{6}{\cancel{7}} \cdot 2 \ 6 \\
 - 1 \ 5 \cdot 8 \ 3 \\
 \hline
 3 \ 1 \cdot 4 \ 3
 \end{array}
 \end{array}
 \qquad
 \begin{array}{r}
 21.8 - 9.29 \\
 \begin{array}{r}
 \overset{1}{\cancel{2}} \ 1 \cdot \overset{7}{\cancel{8}} \ 0 \\
 - \quad 9 \cdot 2 \ 9 \\
 \hline
 1 \ 2 \cdot 5 \ 1
 \end{array}
 \end{array}
 \qquad
 \begin{array}{r}
 21.8 - 9.29 \\
 \begin{array}{r}
 \overset{7}{\cancel{8}} \ 0 \overset{9}{\cancel{1}} \cdot 7 \\
 - \quad 2 \ 4 \ 5 \cdot 3 \\
 \hline
 5 \ 5 \ 6 \cdot 4
 \end{array}
 \end{array}$$

Figure 203: columnar subtraction for calculations involving numbers with up to 2 decimal places

Pupils should make sensible decisions about how and when to use columnar methods. For example, when subtracting a decimal fraction from a whole numbers, pupils may be able to use their knowledge of complements, avoiding the need to exchange through zeroes. For example, to calculate $8 - 4.85$ pupils should be able to work out that the decimal complement to 5 from 4.85 is 0.15, and that the total difference is therefore 3.15.

5NF-1 Secure fluency in multiplication and division facts

Secure fluency in multiplication table facts, and corresponding division facts, through continued practice.

Pupils who have automatic recall of multiplication table facts and corresponding division facts have the best chance of mastering formal written methods. The facts up to 9×9 are required for calculation within the ‘columns’ during application of formal written methods, and all mental multiplicative calculation also depends on these facts.

Pupils will need regular practice of multiplication tables and associated division facts (including calculating division facts with remainders) to maintain the fluency they achieved by the end of year 4.

Pupils should also maintain fluency in related calculations including:

- scaling known multiplicative facts by 10 or 100 ([3NF-3](#) and [4NF-3](#))
- multiplying and dividing by 10 and 100 for calculations that involve whole numbers only ([4MD-1](#))

They should develop fluency in:

- scaling multiplicative facts by one-tenth or one-hundredth ([5NF-2](#))
- multiplying and dividing by 10 and 100, for calculations that bridge 1 ([5MD-1](#))

5MD–3 Multiply using a formal written method

Multiply any whole number with up to 4 digits by any one-digit number using a formal written method.

Pupils must be able to multiply whole numbers with up to 4 digits by one-digit numbers using short multiplication.

$$\begin{array}{r} 24 \\ \times 6 \\ \hline 144 \\ 2 \end{array}$$
$$\begin{array}{r} 342 \\ \times 7 \\ \hline 2,394 \\ 21 \end{array}$$
$$\begin{array}{r} 2,371 \\ \times 4 \\ \hline 9,484 \\ 12 \end{array}$$

Figure 204: short multiplication for multiplication of 2-, 3- and 4-digit numbers by one-digit numbers

Pupils should be fluent in interpreting contextual problems to decide when multiplication is the appropriate operation to use, including as part of multi-step problems. Pupils should use short multiplication when appropriate to solve these calculations. Examples are given in [5MD–3](#).

5MD–4 Divide using a formal written method

Divide a number with up to 4 digits by a one-digit number using a formal written method, and interpret remainders appropriately for the context.

Pupils must be able to divide numbers with up to 4 digits by one-digit numbers using short division, including calculations that involve remainders. Pupils do not need to be able to express remainders arising from short division, using proper fractions or decimal fractions.

$$\begin{array}{r} 14 \\ 7 \overline{)9^28} \end{array}$$
$$\begin{array}{r} 86r2 \\ 5 \overline{)43^32} \end{array}$$
$$\begin{array}{r} 619 \\ 8 \overline{)4,9^15^72} \end{array}$$

Figure 205: short division for division of 2-, 3- and 4-digit numbers by one-digit numbers

Pupils should be fluent in interpreting contextual problems to decide when division is the appropriate operation to use, including as part of multi-step problems. Pupils should use short division when appropriate to solve these calculations. For contextual problems, pupils must be able to interpret remainders appropriately as they learnt to do in year 4 ([4NF–2](#)). Examples are given in [5MD–4](#) Example assessment questions.

Year 6 guidance

Ready-to-progress criteria

Year 5 conceptual prerequisite	Year 6 ready-to-progress criteria	Key stage 3 applications
<p>Understand the relationship between powers of 10 from 1 hundredth to 1,000 in terms of grouping and exchange (for example, 1 is equal to 10 tenths) and in terms of scaling (for example, 1 is ten times the size of 1 tenth).</p>	<p>6NPV-1 Understand the relationship between powers of 10 from 1 hundredth to 10 million, and use this to make a given number 10, 100, 1,000, 1 tenth, 1 hundredth or 1 thousandth times the size (multiply and divide by 10, 100 and 1,000).</p>	<p>Understand and use place value for decimals, measures, and integers of any size.</p> <p>Interpret and compare numbers in standard form $A \times 10^n$, where n is a positive or negative integer or zero.</p>
<p>Recognise the place value of each digit in numbers with units from thousands to hundredths and compose and decompose these numbers using standard and non-standard partitioning.</p>	<p>6NPV-2 Recognise the place value of each digit in numbers up to 10 million, including decimal fractions, and compose and decompose numbers up to 10 million using standard and non-standard partitioning.</p>	<p>Understand and use place value for decimals, measures, and integers of any size.</p> <p>Order positive and negative integers, decimals, and fractions.</p> <p>Use a calculator and other technologies to calculate results accurately and then interpret them appropriately.</p>
<p>Reason about the location of numbers between 0.01 and 9,999 in the linear number system.</p> <p>Round whole numbers to the nearest multiple of 1,000, 100 or 10, as appropriate.</p> <p>Round decimal fractions to the nearest whole number or nearest multiple of 0.01</p>	<p>6NPV-3 Reason about the location of any number up to 10 million, including decimal fractions, in the linear number system, and round numbers, as appropriate, including in contexts.</p>	<p>Order positive and negative integers, decimals, and fractions; use the number line as a model for ordering of the real numbers; use the symbols =, ≠, <, >, ≤, ≥</p> <p>Round numbers and measures to an appropriate degree of accuracy (for example, to a number of decimal places or significant figures).</p> <p>Use approximation through rounding to estimate answers and calculate possible resulting errors expressed using inequality notation $a < x \leq b$</p>

Year 5 conceptual prerequisite	Year 6 ready-to-progress criteria	Key stage 3 applications
<p>Divide 1000, 100 and 1 into 2, 4, 5 and 10 equal parts, and read scales/number lines with 2, 4, 5 and 10 equal parts.</p>	<p>6NPV-4 Divide powers of 10, from 1 hundredth to 10 million, into 2, 4, 5 and 10 equal parts, and read scales/number lines with labelled intervals divided into 2, 4, 5 and 10 equal parts.</p>	<p>Use standard units of mass, length, time, money, and other measures, including with decimal quantities.</p> <p>Construct and interpret appropriate tables, charts, and diagrams.</p>
<p>Be fluent in all key stage 2 additive and multiplicative number facts (see Appendix: number facts fluency overview) and calculation.</p> <p>Manipulate additive equations, including applying understanding of the inverse relationship between addition and subtraction, and the commutative property of addition.</p> <p>Manipulate multiplicative equations, including applying understanding of the inverse relationship between multiplication and division, and the commutative property of multiplication.</p>	<p>6AS/MD-1 Understand that 2 numbers can be related additively or multiplicatively, and quantify additive and multiplicative relationships (multiplicative relationships restricted to multiplication by a whole number).</p>	<p>Understand that a multiplicative relationship between 2 quantities can be expressed as a ratio or a fraction.</p> <p>Express 1 quantity as a fraction of another, where the fraction is less than 1 and greater than 1.</p> <p>Interpret mathematical relationships both algebraically and geometrically.</p> <p>Interpret when the structure of a numerical problem requires additive, multiplicative or proportional reasoning.</p>
<p>Make a given number (up to 9,999, including decimal fractions) 10, 100, 1 tenth or 1 hundredth times the size (multiply and divide by 10 and 100).</p> <p>Apply place-value knowledge to known additive and multiplicative number facts (scaling facts by 10, 100, 1 tenth or 1 hundredth).</p> <p>Manipulate additive equations.</p> <p>Manipulate multiplicative equations.</p>	<p>6AS/MD-1 Use a given additive or multiplicative calculation to derive or complete a related calculation, using arithmetic properties, inverse relationships, and place-value understanding.</p>	<p>Recognise and use relationships between operations including inverse operations.</p> <p>Use algebra to generalise the structure of arithmetic, including to formulate mathematical relationships.</p> <p>Understand and use standard mathematical formulae; rearrange formulae to change the subject.</p>

Year 5 conceptual prerequisite	Year 6 ready-to-progress criteria	Key stage 3 applications
<p>Recall multiplication and division facts up to 12×12.</p> <p>Apply place-value knowledge to known additive and multiplicative number facts.</p>	<p>6AS/MD-3 Solve problems involving ratio relationships.</p>	<p>Use ratio notation, including reduction to simplest form.</p> <p>Divide a given quantity into 2 parts in a given part:part or part:whole ratio; express the division of a quantity into 2 parts as a ratio.</p>
<p>Be fluent in all key stage 2 additive and multiplicative number facts and calculation.</p> <p>Manipulate additive equations.</p> <p>Manipulate multiplicative equations.</p> <p>Find a fraction of a quantity.</p>	<p>6AS/MD-4 Solve problems with 2 unknowns.</p>	<p>Reduce a given linear equation in two variables to the standard form $y = mx + c$; calculate and interpret gradients and intercepts of graphs of such linear equations numerically, graphically and algebraically.</p> <p>Use linear and quadratic graphs to estimate values of y for given values of x and vice versa and to find approximate solutions of simultaneous linear equations.</p>
<p>Recall multiplication and division facts up to 12×12.</p> <p>Find factors and multiples of positive whole numbers, including common factors and common multiples.</p> <p>Find equivalent fractions and understand that they have the same value and the same position in the linear number system.</p>	<p>6F-1 Recognise when fractions can be simplified, and use common factors to simplify fractions.</p>	<p>Use the concepts and vocabulary of prime numbers, factors (or divisors), multiples, common factors, common multiples, highest common factor, lowest common multiple, prime factorisation, including using product notation and the unique factorisation property.</p> <p>Simplify and manipulate algebraic expressions by taking out common factors.</p>

Year 5 conceptual prerequisite	Year 6 ready-to-progress criteria	Key stage 3 applications
<p>Recall multiplication and division facts up to 12×12.</p> <p>Find factors and multiples of positive whole numbers.</p> <p>Find equivalent fractions.</p> <p>Reason about the location of fractions and mixed numbers in the linear number system.</p>	<p>6F–2 Express fractions in a common denomination and use this to compare fractions that are similar in value.</p>	<p>Order positive and negative integers, decimals and fractions.</p> <p>Use the 4 operations, including formal written methods, applied to integers, decimals, proper and improper fractions, and mixed numbers, all both positive and negative.</p> <p>Use and interpret algebraic notation, including: a/b in place of $a \div b$ coefficients written as fractions rather than as decimals.</p>
<p>Reason about the location of fractions and mixed numbers in the linear number system.</p> <p>Find equivalent fractions.</p>	<p>6F–3 Compare fractions with different denominators, including fractions greater than 1, using reasoning, and choose between reasoning and common denomination as a comparison strategy.</p>	<p>Order positive and negative integers, decimals, and fractions; use the number line as a model for ordering of the real numbers; use the symbols =, \neq, $<$, $>$, \leq, \geq</p>
<p>Find the perimeter of regular and irregular polygons.</p> <p>Compare angles, estimate and measure angles in degrees ($^{\circ}$) and draw angles of a given size.</p> <p>Compare areas and calculate the area of rectangles (including squares) using standard units.</p>	<p>6G–1 Draw, compose, and decompose shapes according to given properties, including dimensions, angles and area, and solve related problems.</p>	<p>Draw shapes and solve more complex geometry problems (see Mathematics programmes of study: key stage 3 - Geometry and measures).</p>

6NPV–1 Powers of 10

Understand the relationship between powers of 10 from 1 hundredth to 10 million, and use this to make a given number 10, 100, 1,000, 1 tenth, 1 hundredth or 1 thousandth times the size (multiply and divide by 10, 100 and 1,000).

6NPV–1 Teaching guidance

An understanding of the relationship between the powers of 10 prepares pupils for working with much larger or smaller numbers at key stage 3, when they will learn to read and write numbers in standard form (for example, $600,000,000 = 6 \times 10^8$).

Pupils need to know that what they learnt in year 3 and year 4 about the relationship between 10, 100 and 1,000 (see [3NPV–1](#) and [4NPV–1](#)), and in year 5 about the relationship between 1, 0.1 and 0.01 ([5NPV–1](#)) extends through the number system. By the end of year 6, pupils should have a cohesive understanding of the whole place-value system, from decimal fractions through to 7-digit numbers.

Pupils need to be able to read and write numbers from 1 hundredth to 10 million, written in digits, beginning with the powers of 10, as shown below, and should understand the relationships between these powers of 10.

0 . 0 1	one hundredth
0 . 1	one tenth
1	one
1 0	ten
1 0 0	one hundred
1 , 0 0 0	one thousand
1 0 , 0 0 0	ten thousand
1 0 0 , 0 0 0	one hundred thousand
1 , 0 0 0 , 0 0 0	one million
1 0 , 0 0 0 , 0 0 0	ten million

Pupils should know that each power of 10 is equal to 1 group of 10 of the next smallest power of 10, for example 1 million is equal to 10 hundred thousands.

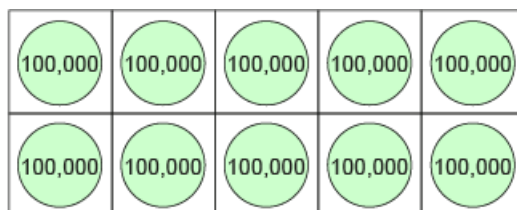

Figure 206: ten 100,000-value place-value counters in a tens frame

Language focus

“10 hundred-thousands is equal to 1 million.”

Pupils should also understand this relationship in terms of scaling by 10 or one-tenth.

Language focus

“1,000,000 is 10 times the size of 100,000.”

“100,000 is one-tenth times the size of 1,000,000.”

Pupils must also understand the relationships between non-adjacent powers of 10 up to a scaling by 1,000 or 1 thousandth (or grouping of up to 1,000 of a given power).

Language focus

“10 thousands is equal to 10,000.”

“10,000 is 10 times the size of 1,000.”

“1,000 is one-tenth times the size of 10,000.”

Pupils must also be able to write multiples of these powers of 10, including when there are more than 10 of given power of 10, for example, 18 hundred thousands is written as 1,800,000. Pupils should be able to restate the quantity in the appropriate power of 10, for example 18 hundred thousands is equal to 1 million 8 hundred thousand.

Once pupils understand the relationships between powers of ten, they should extend this to other numbers in the Gattegno chart. They must be able to identify the number that is 10, 100, 1,000, 1 tenth, 1 hundredth or 1 thousandth times the size of a given number, and associate this with multiplying or dividing by 10, 100 and 1,000. This will prepare pupils for multiplying by decimals in key stage 3, when they will learn, for example, that dividing by 100 is equivalent to multiplying by 0.01.

10,000,000	20,000,000	30,000,000	40,000,000	50,000,000	60,000,000	70,000,000	80,000,000	90,000,000
1,000,000	2,000,000	3,000,000	4,000,000	5,000,000	6,000,000	7,000,000	8,000,000	9,000,000
100,000	200,000	300,000	400,000	500,000	600,000	700,000	800,000	900,000
10,000	20,000	30,000	40,000	50,000	60,000	70,000	80,000	90,000
1,000	2,000	3,000	4,000	5,000	6,000	7,000	8,000	9,000
100	200	300	400	500	600	700	800	900
10	20	30	40	50	60	70	80	90
1	2	3	4	5	6	7	8	9
0.1	0.2	0.3	0.4	0.5	0.6	0.7	0.8	0.9
0.01	0.02	0.03	0.04	0.05	0.06	0.07	0.08	0.09

Figure 207: using the Gattegno chart to multiply and divide by 100

Language focus

“50,000 is 100 times the size of 500.”

“500 multiplied by 100 is equal to 50,000.”

“500 is one-hundredth times the size of 50,000.”

“50,000 divided by 100 is equal to 500.”

Pupils should recognise the inverse relationship between, for example making a number 100 times the size, and returning to the original number by making it one-hundredth times the size.

This understanding should then be extended to multiplicative calculations that involve numbers with *more* than one significant digit, extending what pupils learnt in [5MD-1](#) about multiplying and dividing by 10 and 100.

$$1,659 \times 100 = 165,900$$

$$165,900 \div 100 = 1,659$$

$$21,156 \times 10 = 211,560$$

$$211,560 \div 10 = 21,156$$

$$47.1 \times 1,000 = 47,100$$

$$47,100 \div 1,000 = 47.1$$

Pupils can use the Gattegno chart for support throughout this criterion, but by the end of year 6 they must be able to calculate without it.

You can find out more about fluency and recording for these calculations here in the calculation and fluency section: [Number, place value and number facts: 6NPV-1 and 6NPV-2](#)

Making connections

Writing multiples of powers of 10 depends on 6NPV-2. In 6AS/MD-2 pupils use their understanding of place-value and scaling number facts to manipulate equations.

6NPV-1 Example assessment questions

- Complete the sentences.
 - 500 made 1,000 times the size is _____.
 - 0.7 made 100 times the size is _____.
 - 800,000 made 10 times the size is _____.
 - 4,000,000 made one-thousandth times the size is _____.
 - 9,000 made one-hundredth times the size is _____.
 - 3 made one-tenth times the size is _____.
- The distance from London to Bristol is about 170km. The distance from London to Sydney, Australia is about 100 times as far. Approximately how far is it from London to Sydney?
- A newborn elephant weighs about 150kg. A newborn kitten weighs about 150g. How many times the mass of a newborn kitten is a newborn elephant?
- Walid has a place-value chart and three counters. He has represented the number 1,110,000.

Millions			Thousands			Ones		
100s	10s	1s	100s	10s	1s	100s	10s	1s
		●	●	●				

- Find 2 different numbers that Walid could make so that 1 number is one-hundredth times the size of the other number.
 - Find 2 different numbers that Walid could make so that 1 number is 1,000 times the size of the other number.
- Fill in the missing numbers.

$$\begin{array}{ccc}
 & \times 10 & \\
 & \rightarrow & \\
 \boxed{4.3} & & \boxed{} \\
 & \leftarrow & \\
 & \div 10 &
 \end{array}$$

$$\begin{array}{ccc}
 & \times 10 & \\
 & \rightarrow & \\
 \boxed{} & & \boxed{27,158} \\
 & \leftarrow & \\
 & \div 10 &
 \end{array}$$

$$\begin{array}{ccc} & \times 100 & \\ & \rightarrow & \\ \boxed{729} & & \boxed{} \\ & \leftarrow & \\ & \div 100 & \end{array}$$

$$\begin{array}{ccc} & \times 100 & \\ & \rightarrow & \\ \boxed{} & & \boxed{5,806} \\ & \leftarrow & \\ & \div 100 & \end{array}$$

$$\begin{array}{ccc} & \times 1,000 & \\ & \rightarrow & \\ \boxed{14.3} & & \boxed{} \\ & \leftarrow & \\ & \div 1,000 & \end{array}$$

$$\begin{array}{ccc} & \times 1,000 & \\ & \rightarrow & \\ \boxed{} & & \boxed{2,670,000} \\ & \leftarrow & \\ & \div 1,000 & \end{array}$$

6. Use the following to complete the equations:

$\times 10$ $\times 100$ $\times 1,000$ $\div 10$ $\div 100$ $\div 1,000$

Use each term only once.

$543 \boxed{} = 5.43$

$3,169 \boxed{} = 3,169,000$

$515 \boxed{} = 5,150$

$276,104 \boxed{} = 27,610.4$

$35,000 \boxed{} = 35$

$427 \boxed{} = 42,700$

6NPV–2 Place value in numbers up to 10,000,000

Recognise the place value of each digit in numbers up to 10 million, including decimal fractions, and compose and decompose numbers up to 10 million using standard and non-standard partitioning.

6NPV–2 Teaching guidance

Pupils must be able to read and write numbers up to 10,000,000, including decimal fractions. Pupils should be able to use a separator (such as a comma) every third digit from the decimal separator to help read and write numbers. Pupils must be able to copy numbers from calculator displays, inserting thousands separators and decimal points correctly. This will prepare them for secondary school, where pupils will be expected to know how to use calculators.

Pupils need to be able to identify the place value of each digit in a number.

Language focus

“In 67,000.4...

- the 6 represents 6 ten-thousands; the value of the 6 is 60,000
- the 7 represents 7 thousands; the value of the 7 is 7,000
- the 4 represents 4 tenths; the value of the 4 is 0.4”

Pupils must be able to combine units from millions to hundredths to compose numbers, and partition numbers into these units, and solve related addition and subtraction calculations. Pupils need to experience variation in the order of presentation of the units, so that they understand, for example, that 5,034,000.2 is equal to 4,000 + 30,000 + 0.2 + 5,000,000. Pupils should be able to represent a given number in different ways, including using place-value counters and Gattegno charts, and write numbers shown using these representations.

Pupils should then have sufficient understanding of the composition of large numbers to compare and order them by size.

Pupils also need to be able to solve problems relating to subtraction of any single place-value part from a number, for example:

$$381,920 - 900 = \boxed{}$$

$$381,920 - \boxed{} = 380,920$$

As well as being able to partition numbers in the ‘standard’ way (into individual place-value units), pupils must also be able to partition numbers in ‘non-standard’ ways, and carry out related addition and subtraction calculations, for example:

$$518.32 + 30 = 548.32$$

$$381,920 - 60,000 = 321,920$$

Pupils can initially use place-value counters for support with this type of partitioning and calculation, but by the end of year 6 must be able to partition and calculate without them.

You can find out more about fluency and recording for these calculations here in the calculation and fluency section: [Number, place value and number facts: 6NPV-1 and 6NPV-2](#)

6NPV–2 Example assessment questions

- What is the value of the digit 5 in each of these numbers?
 - 720,541
 - 5,876,023
 - 1,587,900
 - 651,920
 - 905,389
 - 2,120,806.50
 - 8,002,345
 - 701,003.15
- Write a seven-digit number that includes the digit 8 once, where the digit has a value of:
 - 8 million
 - 8 thousand
 - 8 hundred
 - 80 thousand
- Fill in the missing symbols (< or >).

7,142,294 ○ 7,124,294	99,000 ○ 600,000
6,090,100 ○ 690,100	1,300,610 ○ 140,017
589,940 ○ 1,010,222	
- Put these numbers in order from smallest to largest.

8,102,304	8,021,403	843,021	8,043,021
-----------	-----------	---------	-----------

6NPV–3 Numbers up to 10 million in the linear number system

Reason about the location of any number up to 10 million, including decimal fractions, in the linear number system, and round numbers, as appropriate, including in contexts.

6NPV–3 Teaching guidance

Pupils have already learnt about the location of whole numbers with up to 4 digits in the linear number system ([1NPV–2](#), [2NPV–2](#), [3NPV–3](#) and [4NPV–3](#)) and about the location of decimal fractions with up to 2 decimal places between whole numbers in the linear number system ([5NPV–3](#)). Pupils must now extend their understanding to larger numbers.

Pupils need to be able to identify or place numbers with up to 7 digits on marked number lines with a variety of scales, for example placing 12,500 on a 12,000 to 13,000 number line, and on a 10,000 to 20,000 number line.

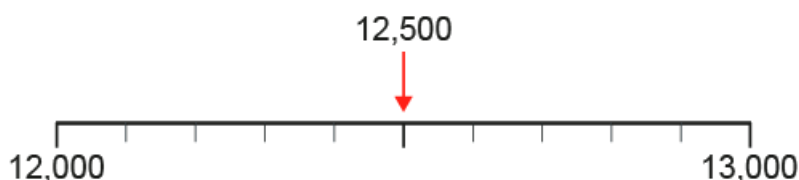

Figure 208: placing 12,500 on a 12,000 to 13,000 number line marked, but not labelled, in multiples of 100

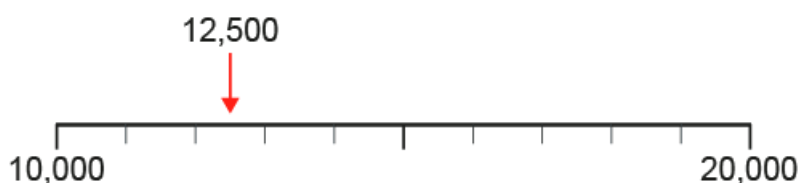

Figure 209: placing 12,500 on a 10,000 to 20,000 number line marked, but not labelled, in multiples of 1,000

Pupils need to be able to estimate the value or position of numbers on unmarked or partially marked numbers lines, using appropriate proportional reasoning.



Figure 210: estimating the position of 65,000 on an unmarked 50,000 to 100,000 number line

In the example below, pupils should reason: “a must be about 875,000 because it is about halfway between the midpoint of the number line, which is 850,000, and 900,000.”



Figure 211: identifying 875,000 on a 800,00 to 900,000 number line marked only with a midpoint

Pupils should understand that, to estimate the position of a number with more significant digits on a large-value number line, they must attend to the leading digits and can ignore values in the smaller place-value positions. For example, when estimating the position of 5,192,012 on a 5,100,000 to 5,200,000 number line they only need to attend to the first 4 digits.

Pupils must also be able to round numbers in preparation for key stage 3, when they will learn to round numbers to a given number of significant figures or decimal places. They have already learnt to round numbers with up to 4 digits to the nearest multiple of 1,000, 100 and 10, and to round decimal fractions to the nearest whole number or multiple of 0.1. Now pupils should extend this to larger numbers. They must also learn that numbers are rounded for the purpose of eliminating an unnecessary level of detail. They must understand that rounding is a method of approximating, and that rounded numbers can be used to give estimated values including estimated answers to calculations.

Pupils should only be asked to round numbers to a useful and appropriate level: for example, rounding 7-digit numbers to the nearest 1 million or 100,000, and 6-digit numbers to the nearest 100,000 or 10,000. Pupils may use a number line for support, but by the end of year 6, they need to be able to round numbers without a number line. As with previous year groups ([3NPV-3](#) , [4NPV-3](#) and [5NPV-3](#)), pupils should first learn to identify the previous and next given multiple of a power of 10, before identifying the closest of these values. In the examples below, for 5,192,012, pupils must be able to identify the previous and next multiples of 1 million and 100,000, and round to the nearest of each.

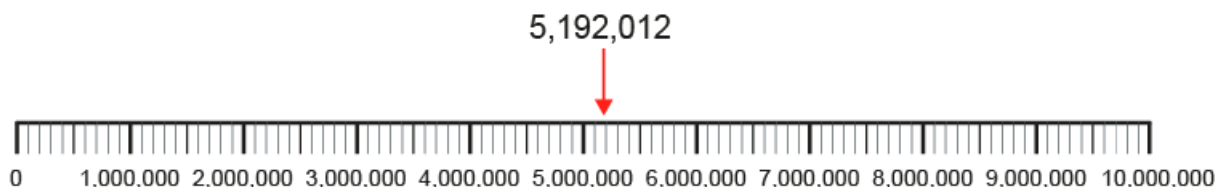

Figure 212: using a number line to identify the previous and next multiple of 1 million

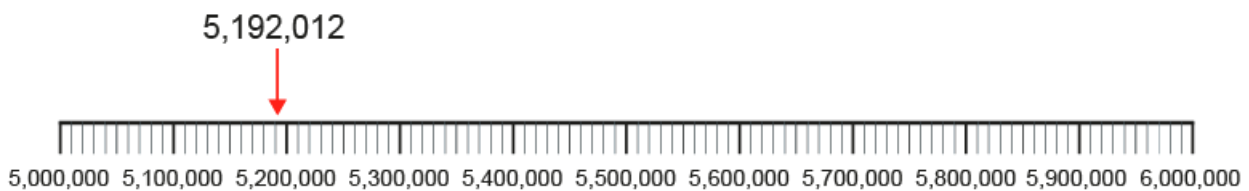

Figure 213: using a number line to identify the previous and next multiple of 100,000

Language focus

“The previous multiple of 1 million is 5 million. The next multiple of 1 million is 6 million.”

“The previous multiple of 100,000 is 5,100,000. The next multiple of 100,000 is 5,200,000.”

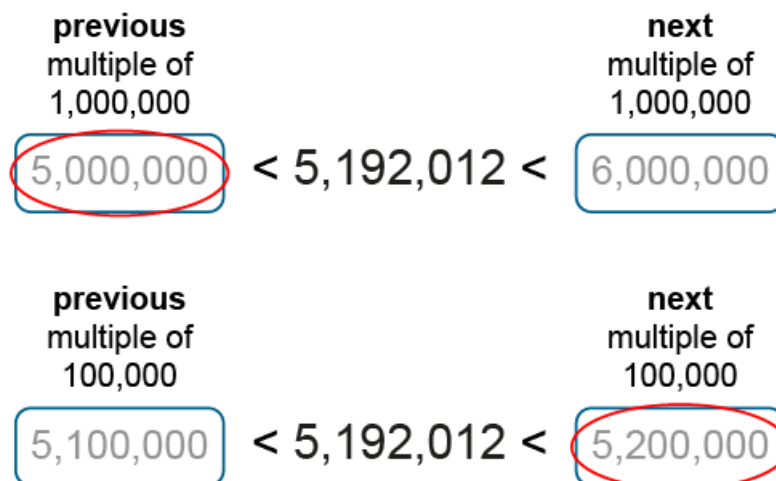

Figure 214: identifying the nearest multiple of 1 million and the nearest multiple of 100,000

Language focus

“The closest multiple of 1 million is 5 million.”

“5,192,012 rounded to the nearest million is 5 million.”

“The closest multiple of 100,000 is 5,200,000.”

“5,192,012 rounded to the nearest 100,000 is 5,200,000.”

Pupils should explore the different reasons for rounding numbers in a variety of contexts, such as the use of approximate values in headlines, and using rounded values for

estimates. They should discuss why a headline, for example, might use a rounded value, and when precise figures are needed.

Finally, pupils should also be able to count forwards and backwards, and complete number sequences, in steps of powers of 10 (1, 10, 100, 1,000, 10,000 and 100,000). Pay particular attention to counting over 'boundaries', for example:

- 2,100,000 2,000,000 1,900,000
- 378,500 379,500 380,500

Making connections

Here, pupils must apply their knowledge from [6NPV-1](#), that each place value unit is made up of 10 of the unit to its right, to understand how each interval on a number line or scale is made up of 10 equal parts. This also links to [6NPV-4](#), in which pupils need to be able to read scales divided into 2, 4, 5 and 10 equal parts.

6NPV-3 Example assessment questions

1. Show roughly where each of these numbers is located on the number line below.

2,783,450 7,000,500 5,250,000 8,192,092 99,000

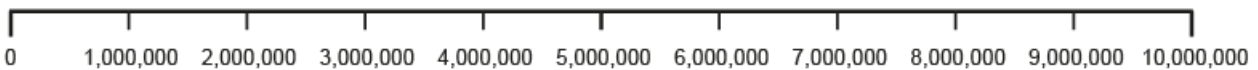

2. Estimate the values of a, b, c and d.

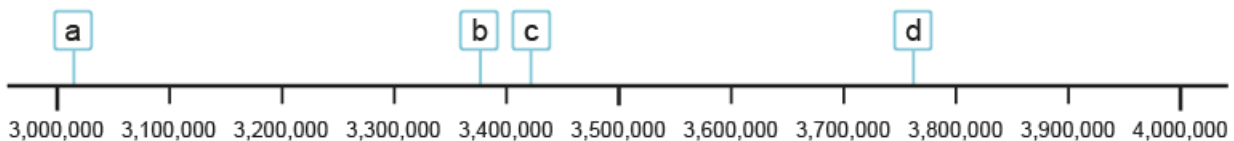

3. For each number:

- write the previous and next multiple of 1 million
- circle the previous or next multiple of 1 million which is closest to the number

previous multiple of 1,000,000		next multiple of 1,000,000
	< 2,783,450 <	
	< 5,192,012 <	
	< 5,811,159 <	
	< 7,683,102 <	

4. Fill in the missing numbers.

6,361,040	6,371,040	6,381,040	6,391,040	6,401,040	6,411,040		
2,004,567	2,003,567	2,002,567	2,001,567	2,000,567	1,999,567		
7,730,004		7,930,004	8,030,004		8,230,004		8,430,004
	9,149,301		9,129,301	9,119,301			9,089,301

5. What might the missing number be in this web page?

Astro Times

Home	History	Star Maps	Contact
<div style="display: flex; align-items: flex-start;"> <div style="flex: 1;">  </div> <div style="flex: 2; padding-left: 10px;"> <p>The Earth's circumference is estimated to be around km. Calculations have shown the distance all around the equator to measure 40,075km.</p> </div> </div>			

6. A swimming pool holds approximately 82,000 litres of water. The capacity of the swimming pool has been rounded to the nearest multiple of 1,000. Fill in the missing numbers to complete the sentences.

- a. The minimum amount of water that the pool could hold is _____.
- b. The maximum amount of water that the pool could hold is _____.

6NPV–4 Reading scales with 2, 4, 5 or 10 intervals

Divide powers of 10, from 1 hundredth to 10 million, into 2, 4, 5 and 10 equal parts, and read scales/number lines with labelled intervals divided into 2, 4, 5 and 10 equal parts.

6NPV–4 Teaching guidance

It is important for pupils to be able to divide powers of 10 into 2, 4, 5 or 10 equal parts because these are the intervals commonly found on measuring instruments and graph scales. Pupils have already learnt to divide 1, 100 and 1,000 in this way ([5NPV–4](#), [3NPV–4](#) and [4NPV–4](#) respectively), and must now extend this to larger powers of 10. Pupils should be able to make connections between powers of 10, for example, describing similarities and differences between the values of the parts when 1 million, 1,000 and 1 are divided into 4 equal parts.

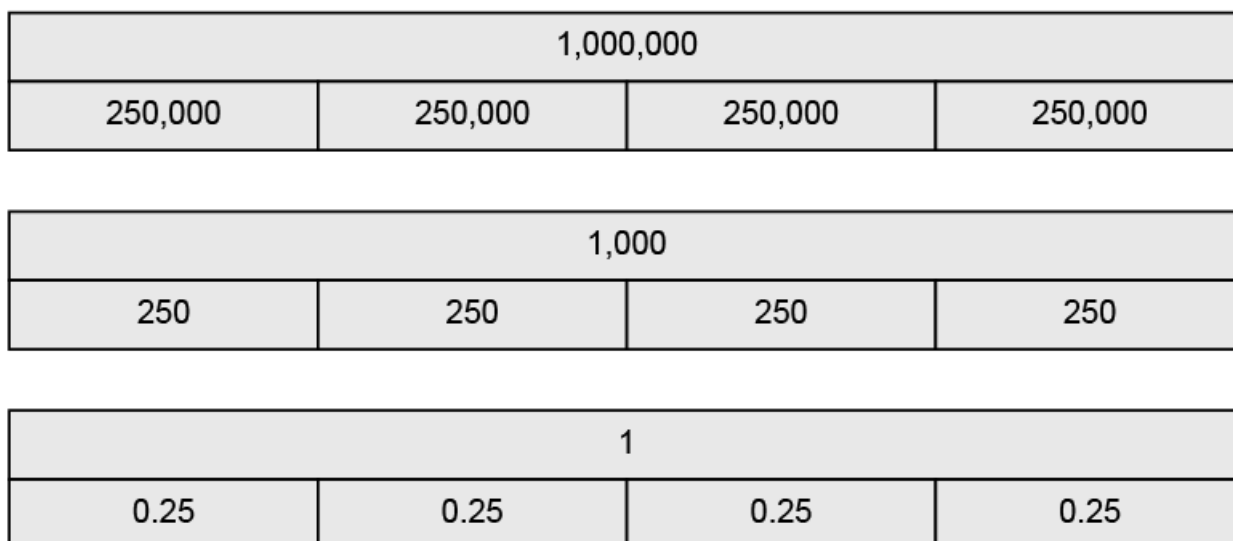

Figure 215: bar models showing 1 million, 1,000 and 1 partitioned into 4 equal parts

Pupils should be able to skip count in these intervals forwards and backwards from any starting number (for example, counting forward from 800,000 in steps of 20,000, or counting backwards from 5 in steps of 0.25). This builds on counting in steps of 10, 20, 25 and 50 in year 3 ([3NPV–4](#)), in steps of 100, 200, 250 and 500 in year 4 ([4NPV–4](#)), and in steps of 0.1, 0.2, 0.25 and 0.5 in year 5 ([5NPV–4](#)).

Pupils should practise reading measurement and graphing scales with labelled power-of-10 intervals divided into 2, 4, 5 and 10 equal parts.

Pupils need to be able to write and solve addition, subtraction, multiplication and division equations related to powers of 10 divided into 2, 4, 5 and 10 equal parts, as exemplified for 1 million and 4 equal parts below. Pupils should be able to connect finding equal parts of a power of 10 to finding $\frac{1}{2}$, $\frac{1}{4}$, $\frac{1}{5}$ or $\frac{1}{10}$ of the value.

$$750,000 + 250,000 = 1,000,000$$

$$1,000,000 - 250,000 = 750,000$$

$$1,000,000 \div 4 = 250,000$$

$$4 \times 250,000 = 1,000,000$$

$$\frac{1}{4} \text{ of } 1,000,000 = 250,000$$

$$1,000,000 - 750,000 = 250,000$$

$$1,000,000 \div 250,000 = 4$$

$$250,000 \times 4 = 1,000,000$$

Making connections

Dividing powers of 10 into 10 equal parts is also assessed as part of [6NPV-1](#).

Reading scales also builds on number-line knowledge from [6NPV-3](#). Conversely, experience of working with scales with 2, 4, 5 or 10 divisions in this criterion improves pupils' estimating skills when working with unmarked number lines and scales as described in [6NPV-3](#).

6NPV-4 Example assessment questions

1. If $\frac{1}{10}$ of a 1kg bag of flour is used, how much is left?
2. In 2005, the population of Birmingham was about 1 million. At that time, about $\frac{1}{5}$ of the population was over 60 years old. Approximately how many over-60s lived in Birmingham in 2005?
3. A builder ordered 1,000kg of sand. She has about 300kg left. What fraction of the total amount is left?
4. Fill in the missing parts.

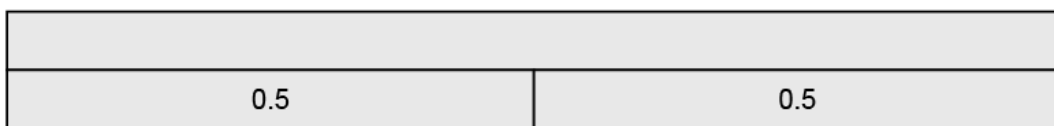
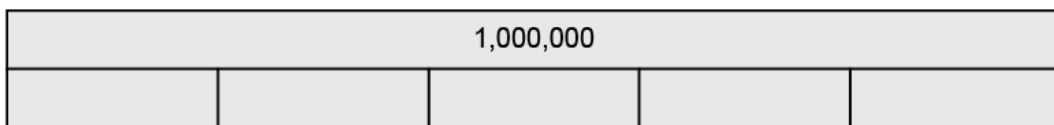
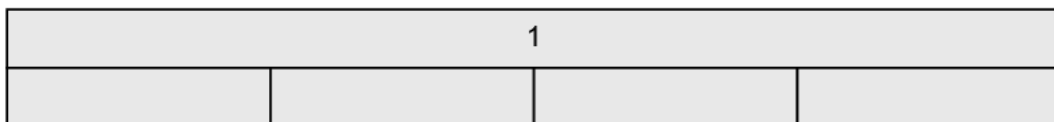
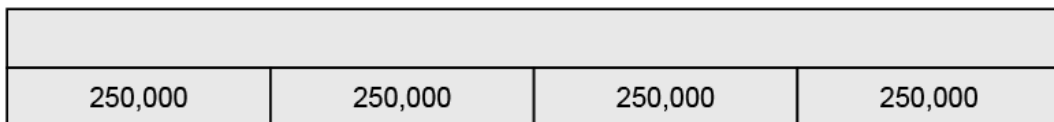
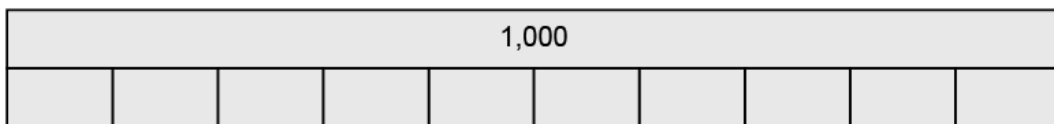
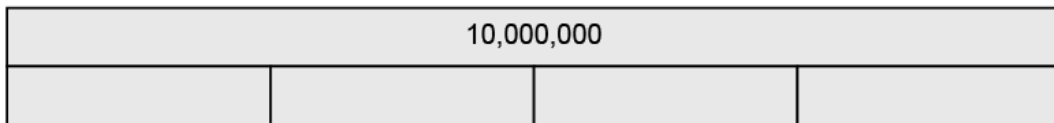

5. Fill in the missing numbers.

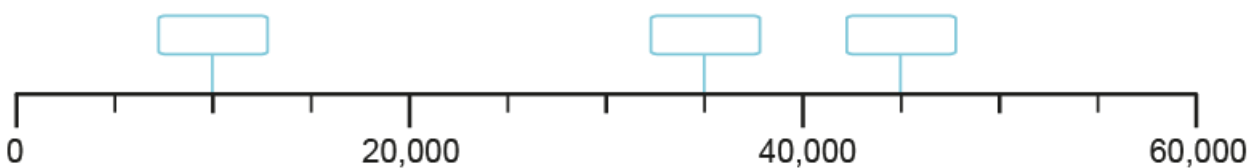

6. The bar chart shows the approximate populations of 3 different towns. What are the populations?

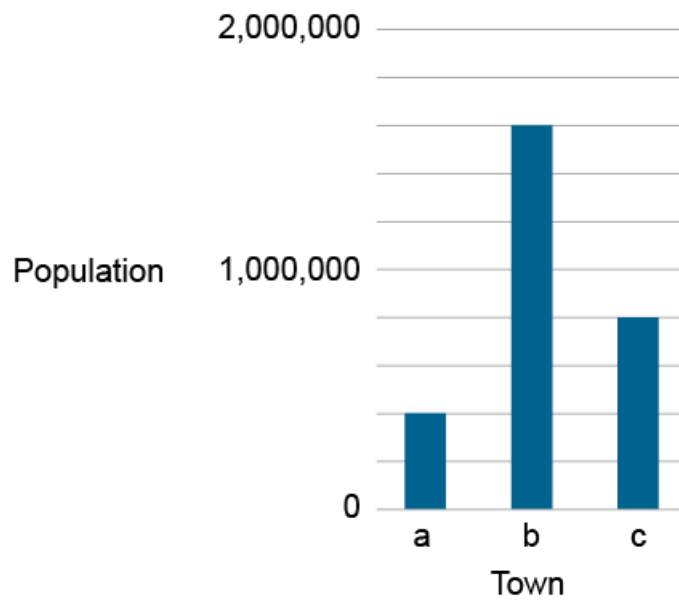

7. What mass does each scale show?

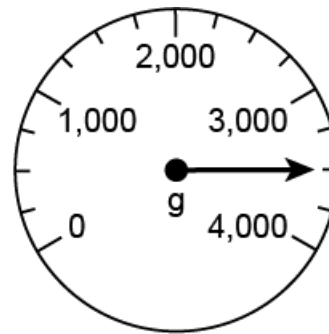
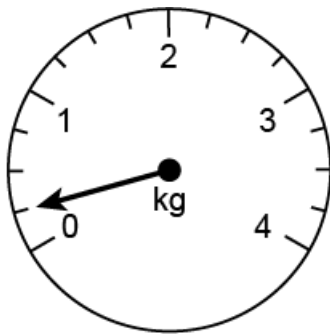

8. Some children are trying to raise £200,000 for charity. The diagram shows how much they have raised so far.

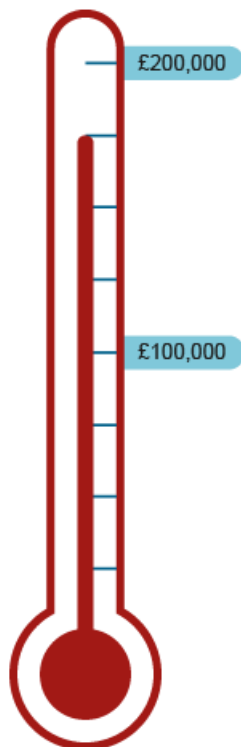

- How much money have they raised?
- How much more money do they need to raise to meet their target?

6AS/MD–1 Quantify additive and multiplicative relationships

Understand that 2 numbers can be related additively or multiplicatively, and quantify additive and multiplicative relationships (multiplicative relationships restricted to multiplication by a whole number).

6AS/MD–1 Teaching guidance

Throughout key stage 2, pupils have learnt about and used 2 types of mathematical relationship between numbers: additive relationships and multiplicative relationships. In year 6, pupils should learn to represent the relationship between 2 given numbers additively or multiplicatively, as well as use such a representation to calculate a missing number, including in measures and statistics contexts.

Consider the following: Holly has cycled 20km. Lola has cycled 60km.

We can describe the relationship between the distances either additively (Lola has cycled 40km further than Holly; Holly has cycled 40km fewer than Lola) or multiplicatively

(Lola has cycled 3 times the distance that Holly has cycled). The relationship between the numbers 20 and 60 can be summarised as follows.

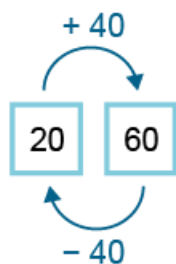

Figure 216: additive relationship between 20 and 60

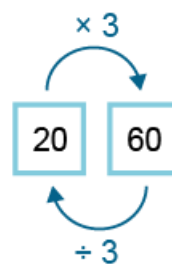

Figure 217: multiplicative relationship between 20 and 60

Language focus

“The relationship between 2 numbers can be expressed additively or multiplicatively.”

As pupils progress into key stage 3, the ability to relate, recognise and use multiplicative relationships is essential. A pupil who can think multiplicatively would, for example, calculate the cost of 1.2m of ribbon at 75p per metre as $1.2 \times 75p$, whereas a pupil who was still thinking only in terms of additive relationships would use the approach of finding the cost of 0.2m (15p) and adding it to the cost of 1m (75p). During key stage 3, pupils will regularly use calculators to solve problems with this type of structure, and the multiplicative approach is more efficient because it involves fewer steps.

Given any 2 numbers (related by a whole-number multiplier), pupils must be able to identify the additive relationship (in the example above, $+40$ and -40) and the multiplicative relationship (in the example above $\times 3$ and $\div 3$). Though multiplicative relationships should be restricted to whole-number multipliers, pupils should be able to connect division by the whole number to scaling by a unit fraction: in the example above, this corresponds to understanding that because $60 \div 3 = 20$, 20 is one-third times the size of 60.

When given a sequence of numbers, pupils should be able to identify whether the terms are all related additively or multiplicatively, identify the specific difference or multiplier and use this to continue a sequence either forwards or backwards. Pupils will need to use formal written methods to calculate larger numbers in sequences.

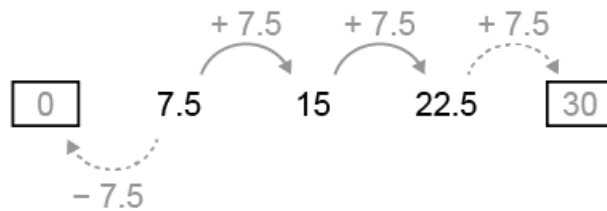

Figure 218: completing a sequence where the difference between adjacent terms is 7.5

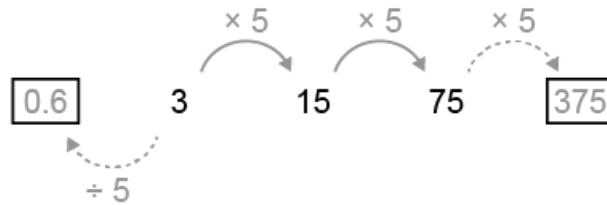

Figure 219: completing a sequence where each term is 5 times the previous

Making connections

In [6AS/MD-4](#) pupils solve problems with 2 unknowns, where the relationship between the unknowns may be additive, multiplicative or both, for example: find 2 numbers, where one is 3 times the size of the other, and the difference between them is 40.

6AS/MD–1 Example assessment questions

1. Fill in the missing numbers.

$300 + \boxed{} = 1,200$

$75 = 3 + \boxed{}$

$\boxed{} + 0.1 = 10$

$300 \times \boxed{} = 1,200$

$75 = 3 \times \boxed{}$

$\boxed{} \times 0.1 = 10$

2. Write an expression in each box to show the relationship between numbers 25 and 75. Is there more than one way to answer this question? Explain.



3. The examples below show the first 2 numbers in a sequence. Find 2 different ways to continue each sequence, using addition for the first and multiplication for the second.

a.

4	16	
---	----	--

 or

4	16	
---	----	--

b.

2	200	
---	-----	--

 or

2	200	
---	-----	--

c.

0.01	10	
------	----	--

 or

0.01	10	
------	----	--

4. Complete these sequences.

0.5	5	9.5				27.5	32
-----	---	-----	--	--	--	------	----

	0.5	0.75	1		
--	-----	------	---	--	--

	25	125	625		
--	----	-----	-----	--	--

0.2	6	180			
-----	---	-----	--	--	--

6AS/MD–2 Derive related calculations

Use a given additive or multiplicative calculation to derive or complete a related calculation, using arithmetic properties, inverse relationships, and place-value understanding.

6AS/MD–2 Teaching guidance

In previous year groups in key stage 2 pupils have learnt about and used the commutative and associative properties of addition ([3AS–3](#)), and the commutative, associative and distributive properties of multiplication ([4MD–2](#) and [4MD–3](#)).

Pupils have also implicitly used the compensation property of addition, for example, when partitioning two-digit numbers in different ways in year 2:

$$70 + 2 = 72 \qquad 60 + 12 = 72$$

In year 6, pupils should learn the compensation property of addition.

Language focus

“If one addend is increased and the other is decreased by the same amount, the sum stays the same.”

Pupils should be able to use the compensation property of addition to complete equations such as $25 + 35 = 27.5 + ?$, and to help them solve calculations such as $27.5 + 32.5$.

Similarly, pupils may have implicitly used the compensation property of multiplication, for example, when recognising connections between multiplication table facts:

$$5 \times 8 = 10 \times 4$$

In year 6, pupils should learn the compensation property of multiplication.

Language focus

“If I multiply one factor by a number, I must divide the other factor by the same number for the product to stay the same.”

Pupils should be able to use the compensation property of multiplication to complete equations such as $0.3 \times 320 = 3 \times ?$, and to help them solve calculations such as 0.3×320 .

Pupils have extensive experience about the effect on the product of scaling one factor from [3NF-3](#), [4F-3](#) and [5NF-2](#), where they learnt to scale known number facts by 10, 100, one-tenth and one-hundredth. Now they can generalise.

Language focus

“If I multiply one factor by a number, and keep the other factor the same, I must multiply the product by the same number.”

Pupils should practise combining their knowledge of arithmetic properties and relationships to solve problems such as the examples here and in the Example assessment questions below.

Example problem 1

Question: Explain how you would use the first equation to complete the second equation:

$$2,448 \div 34 = 72$$

$$72 \times \square = 24,480$$

Explanation:

1. Use the inverse relationship between multiplication and division to restate the equation:
 $72 \times 34 = 2,448$
2. Apply understanding of place-value: the product can be made 10 times the size by making one of the factors 10 times the size.
 $72 \times 340 = 24,480$

Example problem 2

Question: Explain how you would use the first equation to complete the second equation:

$$921 = 349 + 572$$

$$92.1 = 44.9 + \square$$

Explanation:

1. Apply understanding of place value, making the sum and addends 1 tenth times the size.
 $92.1 = 34.9 + 57.2$
2. Apply the compensation property of addition to solve the equation: add 10 to the first addend and subtract 10 from the second addend.
 $92.1 = 44.9 + 47.2$

Pupils should learn to write a series of written equations to justify their solutions.

Being able to work fluently with related equations in this way will prepare pupils for manipulating algebraic equations in key stage 3 and writing proofs.

Pupils can already apply place-value understanding to known multiplication facts to scale one factor, for example, $3 \times 4 = 12$, so $3 \times 40 = 120$. Now they should extend this to scaling both factors, for example, $3 \times 4 = 12$, so $30 \times 40 = 1,200$.

Making connections

In this criterion, pupils use their understanding from [6NPV-1](#) of scaling numbers by 10, 100 and 1,000.

6AS/MD-2 Example assessment questions

1. Fill in the missing numbers.

$$327 + 278 = 330 + \boxed{}$$

$$25 \times 48 = 50 \times \boxed{}$$

2. $327 + 515 = 842$

Use this calculation to complete the following equations.

$$\boxed{} + 61.5 = 84.2$$

$$8,420 - \boxed{} = 3,270$$

$$85,200 - 52,500 = \boxed{}$$

3. $21,760 = 256 \times 85$

Use this calculation to complete the following equations.

$$256 \times 8.5 = \boxed{}$$

$$2,560 \times 85 = \boxed{}$$

$$2,156 \div 85 = \boxed{}$$

4. $3,128 \div 23 = 136$

Use the division calculation so solve the following calculation. Explain your answer.

$$24 \times 136 = \boxed{}$$

5. Fill in the missing number.

$$25 \times 60 = \boxed{} \times 60 + 120$$

6AS/MD–3 Solve problems involving ratio relationships

Solve problems involving ratio relationships.

6ASMD–3 Teaching guidance

Pupils already have the arithmetic skills to solve problems involving ratio. They should now learn to describe 1-to-many (and many-to-1) correspondence structures.

Language focus

“For every 1 cup of rice you cook, you need 2 cups of water.”

“For every 10 children on the school trip, there must be 1 adult.”

Pupils should learn to complete ratio tables, given a 1-to-many or many-to-1 relationship.

cups of rice	1	2	3	4	5	6
cups of water	2	4	6	8	10	12

number of children	10	20	30	40	50	60
number of adults	1	2	3	4	5	6

Pupils must recognise that proportionality is preserved in these contexts, for example, there is always twice the volume of water needed compared to the volume of rice, regardless of how much rice there is. This will prepare pupils for key stage 3, when they will learn to describe correspondence structures using ratio notation and to express ratios in their simplest forms.

Pupils should be able to recognise a 1-to-many or many-to-1 structure, without it being explicitly given and use the relationship to solve problems. For example, here pupils should recognise that, in both examples, for every 1 red bead there are 3 blue beads (or for every 3 blue beads there is 1 red bead), irrespective of the arrangement of the beads.



Key
 red
 blue

Figure 220: bead strings, each with the structure ‘for every 1 red bead, there are 3 blue beads’

For examples like this, pupils should also be able to include the total quantity in a table.

number of red beads	1	2	3	4
number of blue beads	3	6	9	12
total number of beads	4	8	12	16

Pupils should also be able to answer questions such as:

- if there were 5 red beads, how many blue beads would there be?
- if there were 21 blue beads, how many beads would there be altogether?
- if there were 40 beads altogether, how many red beads and how many blue beads would there be?

Pupils must also learn to describe and solve problems related to many-to-many structures.

Language focus

“For every 2 yellow beads there are 3 green beads”.

Pupils may initially use manipulatives, such as cubes or beads, for support, but by the end of year 6, they must be able to complete many-to-many correspondence tables and solve related problems without manipulatives.

number of yellow beads	2	4	6	8
number of green beads	3	6	9	12
total number of beads	5	10	15	20

Pupils should also begin to prepare for using the unitary method at key stage 3, when it is required for unit conversions, percentage calculations and other multiplicative problems. For example, if they are given a smoothie recipe for 2 people (20 strawberries, 1 banana and 150ml milk), they should be able to adjust the recipe by multiplying or dividing by a

whole number, for example, dividing the quantities by 2 to find the amounts for 1 person, or multiplying the quantities by 3 to find the amounts for 6 people. At key stage 3, pupils would then, for example, be able to use the unitary method to adjust the recipe for 5 people, via calculating the amounts for 1 person.

Making connections

To recognise a one-to-many or many-to-one structure, pupils need to be able to identify multiplicative relationships between given numbers ([6AS/MD-2](#)).

6AS/MD-3 Example assessment questions

1. For every 1 litre of petrol, Miss Smith's car can travel about 7km.
 - a. How many kilometres can Miss Smith's car travel on 6 litres of petrol?
 - b. Miss Smith lives about 28km from school. How many litres of petrol does she use to get to school?
2. For every 3m of fence I need 4 fence panels. The fence will be 15m long. How many fence panels will I need?
3. I am decorating a cake with fruit. I use 2 raspberries for every 3 strawberries. Altogether I put 30 berries on the cake.
 - a. How many raspberries did I use?
 - b. How many strawberries did I use?
4. For every 500g of excess baggage I take on an aeroplane, I must pay £7.50. I have 3.5kg of excess baggage. How much must I pay?

5. Lily and Ralph are eating grapes. The diagram represents the relationship between the number of grapes that the children eat.

number of grapes
that Lily eats:

number of grapes
that Ralph eats:

Fill in the missing numbers.

Number of grapes that Lily eats	Number of grapes that Ralph eats
1	
	20
3	

6. Giya is planting flowers in her garden. For every 5 red flowers she plants, she plants 3 yellow flowers. If Giya plants 18 yellow flowers, how many red flowers does she plant?
7. I am making a necklace. So far, it has 4 black beads and 1 white bead. How many more white beads would I need to add so that there are 4 white beads for every 1 black bead?

6AS/MD–4 Solve problems with 2 unknowns

Solve problems with 2 unknowns.

6AS/MD–4 Teaching guidance

Pupils need to be able to solve problems with 2 unknowns where:

- there are an infinite number of solutions
- there is more than 1 solution
- there is only 1 solution

Pupils may have seen equations with 2 unknowns before, for example, when recognising connections between multiplication table facts:

$$5 \times \square = 10 \times \square$$

In year 6, pupils must recognise that an equation like this has many (an infinite number) of solutions. They should learn to provide example solutions by choosing a value for one unknown and then calculating the other unknown.

Pupils should be able to solve similar problems where there is more than one solution, but not an infinite number, for example:

Danny has some 50p coins and some 20p coins. He has £1.70 altogether. How many of each type of coin might he have?

In these cases, pupils may choose a value for the first unknown and be unable to solve the equation for the other unknown (pupils may first set the number of 50p pieces at 2, giving £1, only to find that it is impossible to make up the remaining 70p from 20p coins). Pupils should then try a different value until they find a solution. For a bound problem with only a few solutions, like the coin example, pupils should be able to find all possible solutions by working systematically using a table like that shown below. They should be able to reason about the maximum value in each column.

Number of coins	Quantity in 50p coins	Quantity in 20p coins
1	50p	20p
2	£1	40p
3	£1.50	60p
4		80p
5		£1
6		£1.20
7		£1.40
8		£1.60

Figure 221: finding the 2 solutions to the coin problem: one 50p coin and six 20p coins, or three 50p coins and one 20p coin

Pupils must also learn to solve problems with 2 unknowns that have only 1 solution. Common problems of this type involve 2 pieces of information being given about the relationship between the 2 unknowns – 1 piece of additive information and either another piece of additive information or a piece of multiplicative information. Pupils should learn to draw models to help them solve this type of problem.

Example problem 1

Question: The sum of 2 numbers is 25, and the difference between them is 7. What are the 2 numbers?

Solution:

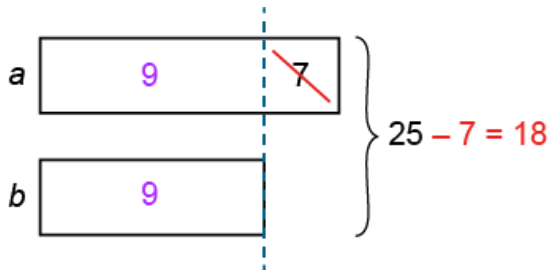

Figure 222: using a bar model to solve a problem with 2 unknowns – example 1

$$a = 9 + 7 = 16$$

$$b = 9$$

The numbers are 16 and 9.

Example problem 2

Question: The sum of 2 numbers is 48. One number is one-fifth times the size of the other number. What are the 2 numbers?

Solution:

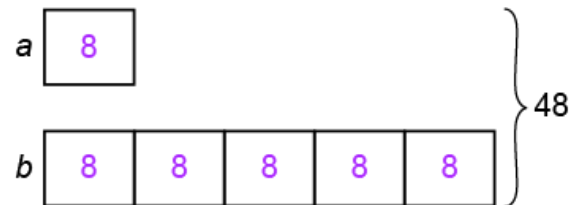

Figure 223: using a bar model to solve a problem with 2 unknowns – example 2

$$a = 8$$

$$b = 5 \times 8 = 40$$

The numbers are 8 and 40.

Pupils should also be able to use bar modelling to solve more complex problems with 2 unknowns and 1 solution, such as: 4 pears and 5 lemons cost £3.35. 4 pears and 2 lemons cost £2.30. What is the cost of 1 lemon?

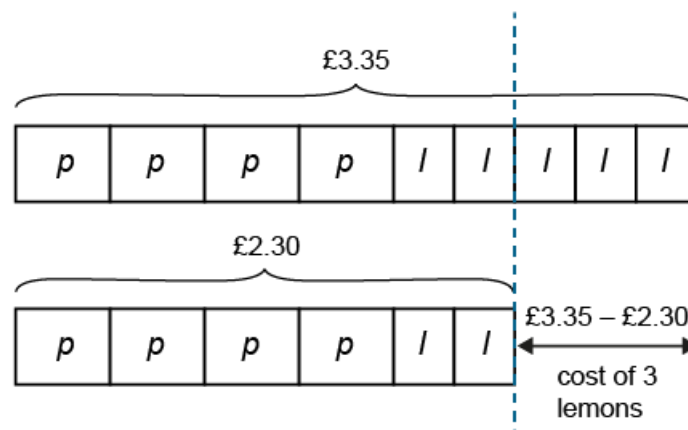

$$\text{cost of 3 lemons} = £3.35 - £2.30 = £1.05$$

so

$$\text{cost of 1 lemon} = £1.05 \div 3 = £0.35$$

Figure 224: using a bar model to solve a problem with 2 unknowns – example 3

Solving problems with 2 unknowns and 1 solution will prepare pupils for solving simultaneous equations in key stage 3.

Pupils should practise solving a range of problems with 2 unknowns, including contextual measures and geometry problems.

Making connections

Within this criterion, pupils must be able to use their understanding of how 2 numbers can be related additively or multiplicatively ([6AS/MD-1](#)). In [6G-1](#) pupils solve geometry problems with 2 unknowns, for example, finding the unknown length and unknown width of a rectangle with a perimeter of 14cm.

6AS/MD-4 Example assessment questions

1. A baker is packing 60 cakes into boxes. A small box can hold 8 cakes and a large box can hold 12 cakes.
 - a. How many different ways can he pack the cakes?
 - b. How can he pack the cakes with the fewest number of boxes?
2. 1 eraser and 5 pencils cost a total of £3.35.
5 erasers and 5 pencils cost a total of £4.75.
 - a. How much does 1 eraser cost?
 - b. How much does 1 pencil cost?
3. An adult ticket for the zoo costs £2 more than a child ticket. I spend a total of £33 buying 3 adult and 2 child tickets.
 - a. How much does an adult ticket cost?
 - b. How much does a child ticket cost?
4. The balances show the combined masses of some large bags of dog food and some small bags of dog food.

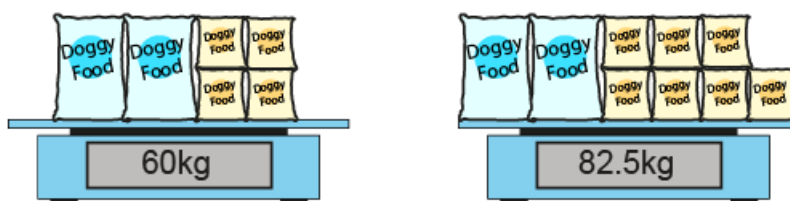





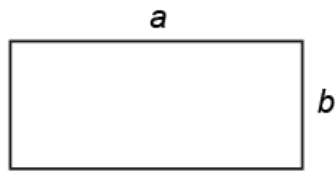



How much does each bag-size cost?

5. A rectangle with side-lengths a and b has a perimeter of 30cm. a is a 2-digit whole number and b is a 1-digit whole number. What are the possible values of a and b ?



6. The diagram shows the total cost of the items in each row and column. Fill in the 2 missing costs.

			£1.15
			£1.25
			95p
		95p	

6F–1 Simplify fractions

Recognise when fractions can be simplified, and use common factors to simplify fractions.

6F–1 Teaching guidance

In year 5, pupils learnt to find equivalent fractions ([5F–2](#)). Now pupils must build on this and learn to recognise when fractions are not in their simplest form. They should use their understanding of common factors ([5MD–2](#)) to simplify fractions.

Pupils should learn that when the numerator and denominator of a fraction have no common factors (other than 1) then the fraction is in its simplest form. Pupils should learn that a fraction can be simplified by dividing both the numerator and denominator by a common factor. They must realise that simplifying a fraction does not change its value, and the simplified fraction has the same position in the linear number system as the original fraction. Pupils should begin with fractions where the numerator and denominator have only one common factor other than 1, for example $\frac{6}{15}$.

$$\frac{6}{15} = \frac{2}{5}$$

Two blue curved arrows indicate the division process. The top arrow goes from 6 to 2 with $\div 3$ written above it. The bottom arrow goes from 15 to 5 with $\div 3$ written below it.

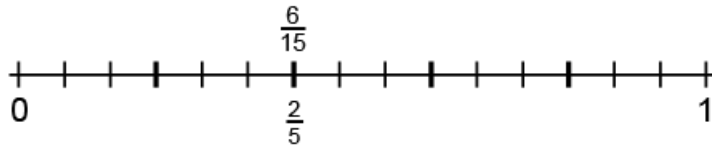

Figure 225: simplifying $\frac{6}{15}$ by dividing the numerator and denominator by the common factor of 3

Language focus

“A fraction can be simplified when the numerator and denominator have a common factor other than 1.”

Pupils should then learn to simplify fractions where the numerator and denominator share several common factors, for example $\frac{4}{12}$. Pupils should understand that they should divide the numerator and denominator by the highest common factor to express a fraction in its simplest form, but that the simplification can also be performed in more than 1 step.

$$\frac{4}{12} = \frac{1}{3}$$

Two blue curved arrows indicate the division process. The top arrow goes from 4 to 1 with $\div 4$ written above it. The bottom arrow goes from 12 to 3 with $\div 4$ written below it.

Figure 226: simplifying $\frac{4}{12}$ by dividing the numerator and denominator by the highest common factor

$$\frac{4}{12} = \frac{2}{6} = \frac{1}{3}$$

Four blue curved arrows indicate the two-step division process. The top-left arrow goes from 4 to 2 with $\div 2$ written above it. The top-right arrow goes from 2 to 1 with $\div 2$ written above it. The bottom-left arrow goes from 12 to 6 with $\div 2$ written below it. The bottom-right arrow goes from 6 to 3 with $\div 2$ written below it.

Figure 227: simplifying $\frac{4}{12}$ in 2 steps

Language focus

“To convert a fraction to its simplest form, divide both the numerator and the denominator by their highest common factor.”

Pupils should learn to always check their answer when simplifying a fraction to confirm that it is in its simplest form and the only remaining common factor is 1.

Pupils should be able to simplify fractions:

- where the numerator is a factor of the denominator (and therefore also the highest common factor), for example, $\frac{3}{9}$ or $\frac{7}{28}$, resulting in a simplified fraction that is a unit fraction
- where the numerator is not a factor of the denominator, for example, $\frac{4}{14}$ or $\frac{15}{20}$, resulting in a simplified fraction that is a non-unit fraction

In year 4 pupils learnt to convert between mixed numbers and improper fractions (**4F-2**) and to add and subtract fractions to give a sum greater than 1 (**4F-3**). This criterion on simplifying fractions provides an opportunity for pupils to continue to practise these skills as they learn how to simplify fractions with a value greater than 1.

Pupils should consider calculations such as $\frac{9}{12} + \frac{11}{12}$ and understand that the resulting improper fraction, $\frac{20}{12}$, can be simplified either directly, or by first converting to a mixed number and then simplifying the fractional part.

$$\frac{20}{12} = \frac{5}{3} = 1\frac{2}{3}$$

Figure 228: simplifying $\frac{20}{12}$ to $\frac{5}{3}$, then converting to a mixed number

$$\frac{20}{12} = 1\frac{8}{12} = 1\frac{2}{3}$$

Figure 229: converting $\frac{20}{12}$ to $\frac{5}{3}$, then simplifying

6F-1 Example assessment questions

- Sort these fractions according to whether they are expressed in their simplest form or not.

$$\frac{3}{15} \quad \frac{2}{5} \quad \frac{4}{20} \quad \frac{25}{36} \quad \frac{1}{6} \quad \frac{7}{21} \quad \frac{18}{30} \quad \frac{9}{17} \quad \frac{5}{15} \quad \frac{11}{20} \quad \frac{23}{30}$$

Fraction in its simplest form	Fraction <u>not</u> in its simplest form

2. Solve these calculations, giving each answer in the simplest form.

$$\frac{2}{9} + \frac{4}{9}$$

$$\frac{3}{7} - \frac{1}{7}$$

$$\frac{4}{15} + \frac{2}{15}$$

$$\frac{5}{12} + \frac{5}{12} - \frac{2}{12}$$

$$\frac{2}{13} + \frac{7}{13} - \frac{4}{13}$$

$$\frac{4}{5} + \frac{4}{5}$$

$$\frac{7}{10} + \frac{5}{10} + \frac{3}{10}$$

$$\frac{8}{9} + \frac{8}{9} - \frac{1}{9}$$

$$3\frac{7}{10} + 2\frac{9}{10}$$

$$\frac{13}{8} + \frac{11}{8}$$

$$7\frac{1}{6} - 1\frac{2}{6}$$

$$\frac{17}{3} - \frac{5}{3}$$

3. Ahmed says, "To simplify a fraction, you just halve the numerator and halve the denominator." Is Ahmed's statement always true, sometimes true or never true? Explain your answer.

4. Put these numbers in order from smallest to largest by simplifying them to unit fractions.

$$\frac{3}{18}$$

$$\frac{5}{20}$$

$$\frac{4}{8}$$

$$\frac{2}{18}$$

$$\frac{4}{12}$$

$$\frac{6}{60}$$

5. How much water is in this beaker? Write your answer as a fraction of a litre in its simplest form.

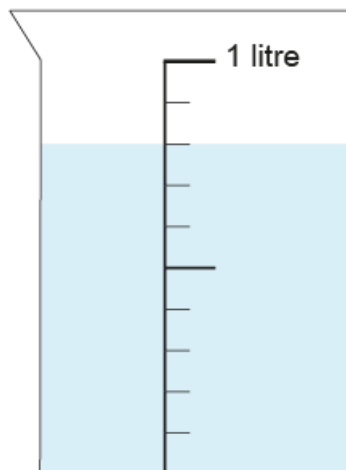

6F–2 Express fractions in a common denomination

Express fractions in a common denomination and use this to compare fractions that are similar in value.

6F–2 Teaching guidance

Pupils should already be able to identify multiples of numbers, and common multiples of numbers within the multiplication tables ([4NF–1](#) and [5MD–2](#)). To be ready to progress to key stage 3, given 2 fractions pupils must be able to express them with the same denominator.

Pupils should first work with pairs of fractions where one denominator is a multiple of the other, for example, $\frac{1}{5}$ and $\frac{4}{15}$. They should learn that the denominator that is the multiple (here 15) can be used as a common denominator. Pupils should then be able to apply what they already know about writing equivalent fractions ([5F–2](#)) to express the fractions in a common denomination.

Language focus

“We need to compare the denominators of $\frac{1}{5}$ and $\frac{4}{15}$.”

“15 is a multiple of 5.”

“We can use 15 as the common denominator.”

“We need to express both fractions in fifteenths.”

$$\frac{1}{5} = \frac{3}{15}$$

Figure 230: expressing $\frac{1}{5}$ in fifteenths

Pupils must then learn to work with pairs of fractions where one denominator is not a multiple of the other, for example, $\frac{1}{3}$ and $\frac{3}{8}$. Pupils should recognise when 1 denominator is not a multiple of the other (here, 3 is not a factor of 8 and 8 is not a multiple of 3) and learn to identify a new denominator that is a common multiple of both denominators. Again, pupils should then be able to apply what they already know about

writing equivalent fractions to express the fractions in a common denominator.

Language focus

“We need to compare the denominators of $\frac{1}{3}$ and $\frac{3}{8}$.”

“8 is not a multiple of 3.”

“24 is a multiple of both 3 and 8.”

“We can use 24 as the common denominator.”

“We need to express both fractions in twenty-fourths.”

$$\frac{1}{3} = \frac{8}{24} \quad \frac{3}{8} = \frac{9}{24}$$

Figure 231: expressing $\frac{1}{3}$ and $\frac{3}{8}$ in twenty-fourths

At key stage 3, pupils will learn to find the lowest common multiple of any 2 numbers. At key stage 2, being able to find a common multiple of the denominators by multiplying the 2 denominators is sufficient.

Language focus

“If one denominator is not a multiple of the other, we can multiply the two denominators to find a common denominator.”

This does not always result in the lowest common denominator (for example $\frac{1}{6}$ and $\frac{2}{9}$ can be expressed with a common denominator of 18 rather than 54), and if pupils can identify a lower common denominator then they should use it. Pupils may also recognise when the resulting pair of common denomination fractions can be simplified.

Pupils should also be able to find a common denominator for more than 2 fractions, such as $\frac{1}{3}$, $\frac{4}{15}$ and $\frac{2}{5}$, when 1 of the denominators is a multiple of the other denominators (in this case 15).

Once pupils know how to express fractions with a common denominator, they can use this to compare and order fractions.

Language focus

“If the denominators are the same, then the larger the numerator, the larger the fraction.”

Making connections

In 6F-1 <link> pupils learnt to simplify fractions, and applied this to compare and order fractions that can be simplified to unit fractions (see 6F-1 Example assessment questions <link>, question 4). In this criterion, pupils learnt to express fractions in a common denomination, and use this to compare and order fractions. Pupils should be able to identify which method is appropriate for a given pair or set of fractions. Pupils learn more about comparing fractions, and choosing an appropriate method in 6F-3 <link>.

6F–2 Example assessment questions

1. Fill in the missing symbols (<, > or =). You will need to simplify some of the fractions and express each pair with a common denominator.

$$\frac{5}{7} \bigcirc \frac{2}{3}$$

$$\frac{6}{10} \bigcirc \frac{3}{5}$$

$$\frac{7}{9} \bigcirc \frac{3}{4}$$

$$\frac{5}{7} \bigcirc \frac{6}{8}$$

$$\frac{2}{3} \bigcirc \frac{7}{10}$$

$$\frac{2}{6} \bigcirc \frac{3}{9}$$

$$\frac{3}{11} \bigcirc \frac{1}{3}$$

$$\frac{1}{5} \bigcirc \frac{2}{11}$$

2. Express each set of fractions with a common denominator. Then put them in order from smallest to largest.

a. $\frac{4}{20}$ $\frac{1}{4}$ $\frac{3}{10}$ $\frac{2}{5}$

b. $\frac{2}{9}$ $\frac{1}{3}$ $\frac{1}{6}$ $\frac{4}{18}$

- Ahmed has a beaker containing $\frac{7}{10}$ of a litre of water. Imran has a beaker containing $\frac{3}{5}$ of a litre of water. Express the fractions with a common denominator to work out whose beaker contains the most water.
- Ben and Felicity are both trying to raise the same amount of money for charity. So far, Ben has raised $\frac{3}{4}$ of the amount, while Felicity has raised $\frac{5}{7}$ of the amount. Express the fractions with a common denominator to work out who is closest to meeting their target.

6F–3 Compare fractions with different denominators

Compare fractions with different denominators, including fractions greater than 1, using reasoning, and choose between reasoning and common denomination as a comparison strategy.

6F–3 Teaching guidance

In [6F–2](#) pupils learnt to compare any 2 fractions by expressing them with a common denominator. However fractions can often be compared by reasoning, without the need to express them with a common denominator.

Pupils can already compare unit fractions.

Language focus

“If the numerators are both 1, then the larger the denominator, the smaller the fraction.”

Pupils should now extend this to compare other fractions with the same numerator, for example, because $\frac{1}{5}$ is greater than $\frac{1}{6}$ we know that $\frac{2}{5}$ is greater than $\frac{2}{6}$.

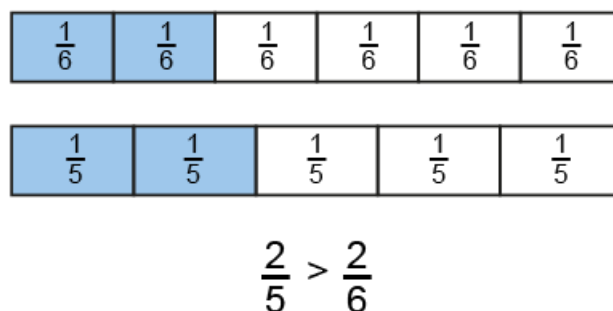

Figure 232: bar models to compare $\frac{2}{5}$ and $\frac{2}{6}$

Language focus

“If the numerators are the same, then the larger the denominator, the smaller the fraction.”

Pupils should be able to use reasoning in other ways when comparing fractions:

- For each fraction they should be able to visualise where it is positioned on a number line, for example, thinking about whether it is greater than or less than $\frac{1}{2}$ or whether it is close to 0 or 1.
- Pupils should be able to reason about the relationship between the numerator and the denominator of each fraction, asking themselves ‘Is this fraction a large or small part of the whole?’. They should be able to reason, for example, $\frac{5}{6}$ is greater than $\frac{7}{11}$ because 5 is a larger part of 6 than 7 is of 11.
- For fractions that are a large part of the whole, pupils should be able to reason about how close each fraction is to the whole. For example, $\frac{7}{8}$ is $\frac{1}{8}$ less than the whole, while $\frac{6}{7}$ is $\frac{1}{7}$ less than the whole. Since $\frac{1}{8}$ is less than $\frac{1}{7}$, $\frac{7}{8}$ must be larger than $\frac{6}{7}$.

For a given pair or set of fractions, pupils must learn to assess whether it is more appropriate to compare them using reasoning or to express them in a common denomination.

Making connections

When given a pair or set of fractions to compare, pupils may need to convert some of the fractions to their simplest form ([6F-1](#)). They then need to assess whether it is more appropriate to compare them using reasoning (this criterion) or to express them in a common denomination ([6F-2](#)).

6F–3 Example assessment questions

1. Which number(s) could go in the missing-number box to make this statement true?

$$\frac{1}{4} > \frac{1}{\square} > \frac{1}{10}$$

2. Without using a common denominator, put each set of fractions in order from smallest to largest.

a. $\frac{10}{8}$ $\frac{7}{8}$ $\frac{5}{8}$ $\frac{3}{8}$ $\frac{8}{8}$ $\frac{4}{8}$ $\frac{2}{8}$

b. $\frac{1}{6}$ $\frac{1}{5}$ $\frac{1}{8}$ $\frac{1}{7}$ $\frac{1}{10}$ $\frac{1}{9}$

c. $\frac{3}{3}$ $\frac{3}{8}$ $\frac{3}{11}$ $\frac{3}{100}$ $\frac{3}{5}$ $\frac{3}{2}$

3. Sabijah and Will are in a running race. Sabijah has run $\frac{9}{10}$ of the race. Will has run $\frac{8}{9}$ of the race. Who is further ahead? Explain your reasoning.

4. Fill in the missing symbols (<, > or =).

$$\frac{5}{6} \bigcirc \frac{4}{7}$$

$$\frac{8}{9} \bigcirc \frac{7}{11}$$

5. Think of a number that can go in each box so that the fractions are arranged in order from smallest to largest.

$$\frac{1}{3} \quad \frac{\square}{5} \quad \frac{1}{\square} \quad \frac{4}{7} \quad \frac{3}{\square}$$

6G–1 Draw, compose and decompose shapes

Draw, compose, and decompose shapes according to given properties, including dimensions, angles and area, and solve related problems.

6G–1 Teaching guidance

Through key stage 2, pupils have learnt to measure perimeters, angles and areas of shapes, and have learnt to draw polygons by joining marked points ([3G–2](#)) and draw angles of a given size ([5G–1](#)). By the end of year 6, pupils must be able to draw, compose and decompose shapes defined by specific measurements. Composing and decomposing shapes prepares pupils for solving geometry problems at key stage 3, for example, finding the area of a trapezium by decomposing it to a rectangle and 2 triangles.

Pupils should be able to draw a named shape to meet a given measurement criterion, for example:

- drawing a rectangle, on squared-centimetre paper, with a perimeter of 14cm (Example 1 below)
- drawing a pentagon, on squared-centimetre paper, with an area of 10cm^2 (Example 2 below)
- drawing a triangle at actual size, based on a sketch with labelled lengths and angles (see [6G–1](#), question 5)

Example 1

Task: draw a rectangle with a perimeter of 14cm.

Example solution:

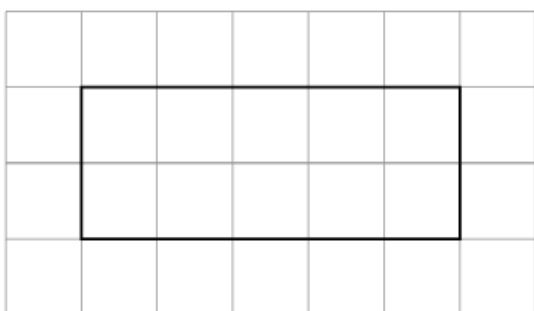

Figure 233: a 5cm by 2cm rectangle on a squared-centimetre grid

Drawn to actual size.

Example 2

Task: draw a pentagon with an area of 10cm^2 .

Example solution:

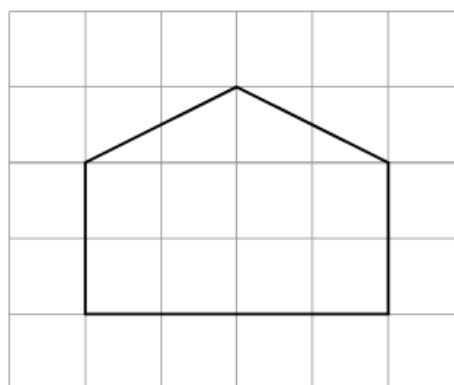

Figure 234: an irregular pentagon with an area of 10cm^2

Drawn to actual size.

Examples like these involve more than 1 unknown and have more than 1 solution. Pupils should learn to choose a value for 1 of the variables and work out other unknowns from this. For example, to draw a rectangle with a perimeter of 14cm, the width could be chosen to be 1cm and the length then calculated to be 6cm, or the width could be chosen to be 2cm and the length then calculated to be 5cm. There are 6 possible whole-number solutions to this problem (counting the same rectangle in a different orientation as a separate solution), and pupils may provide any one of them to complete the task.

Pupils should be able to reason about dimensions or areas given for part of a shape to determine the values for other parts of a shape or for a compound shape.

Example 3

Problem: find the perimeter of the large rectangle on the right.

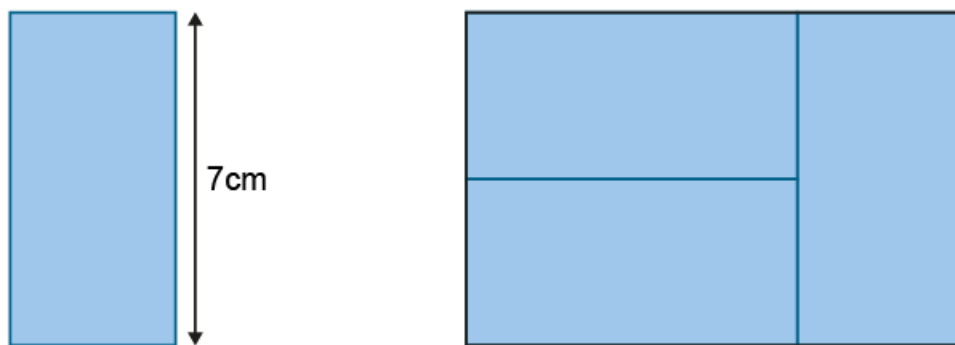

Figure 235: problem involving a compound shape made from 3 identical rectangles

Drawn to scale, not actual size

Solution: perimeter of large rectangle = 35cm

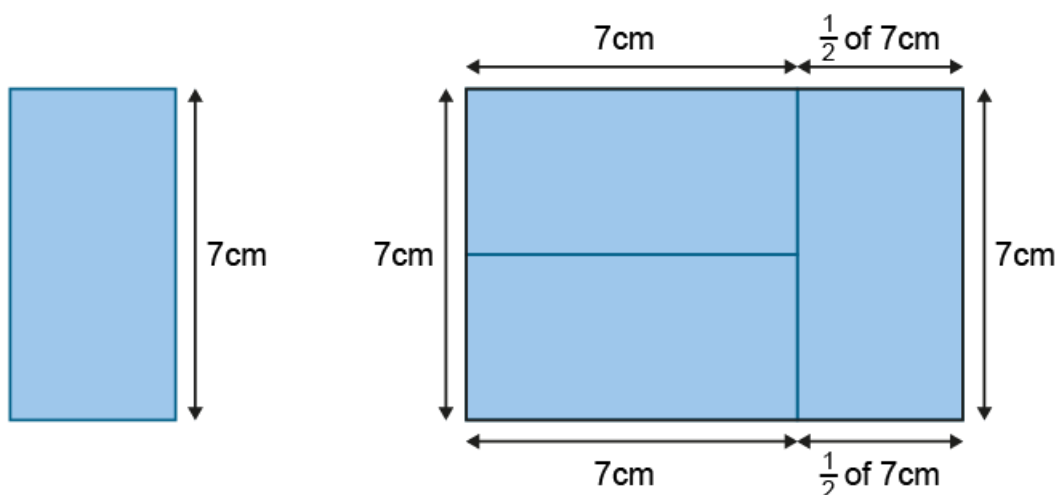

Figure 236 solving a problem involving a compound shape made from 3 identical rectangles

Drawn to scale, not actual size

Further examples are provided below in [6G-1](#), questions 4 and 8.

Making connections

In 6AS/MD-4 pupils learnt to solve problems with 2 unknowns. Drawing a shape to match given properties can correspond to a problem with 2 unknowns (Example 1 above) or more (Example 2 above).

6G-1 Example assessment questions

1. Lois has started drawing a shape on this squared-centimetre grid. Complete her shape so that it has an area of 14cm^2 .

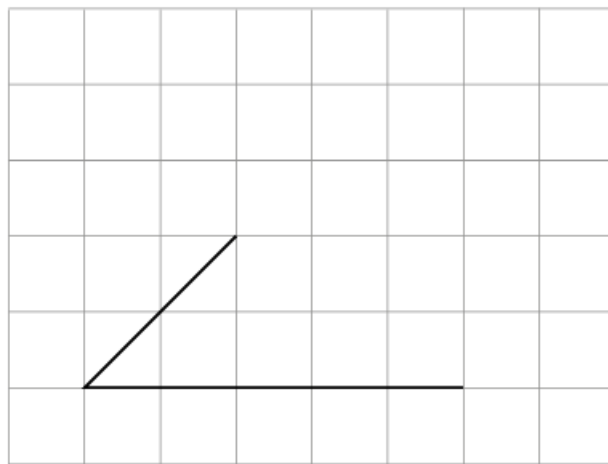

Drawn to actual size

2. Here is a rhombus on a triangular grid. Draw a different shape with the same area on the grid.

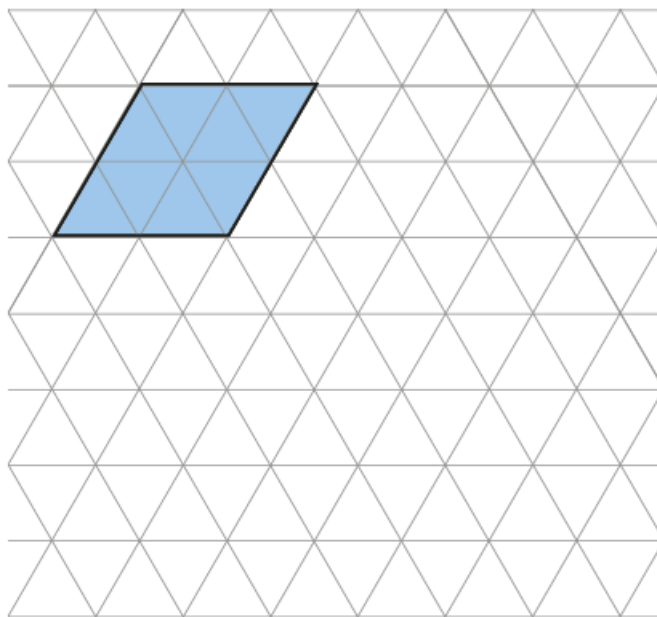

3. Draw a hexagon on this squared-centimetre grid. Include one side of length 4cm and one side of length 3cm.

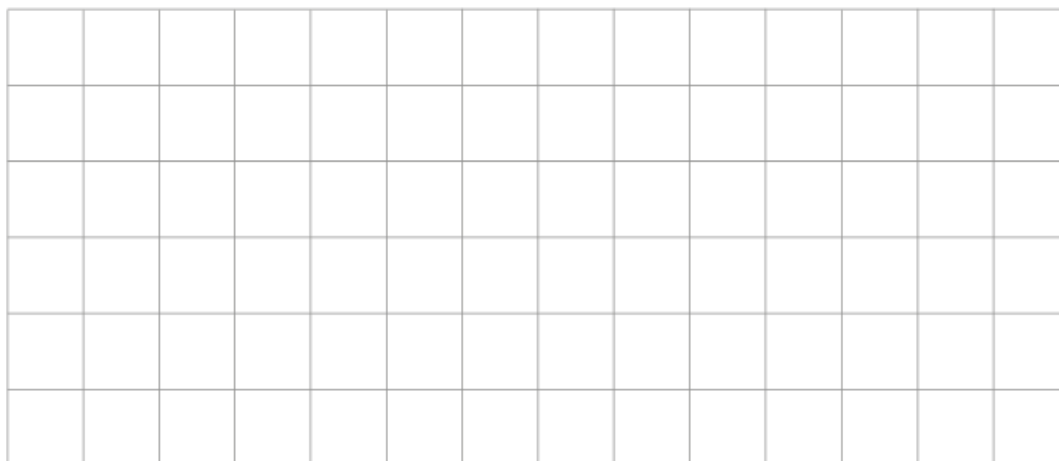

4. Here is a square made from 4 smaller squares. The area of the large square is 64cm^2 . What is the length of 1 side of each small square?

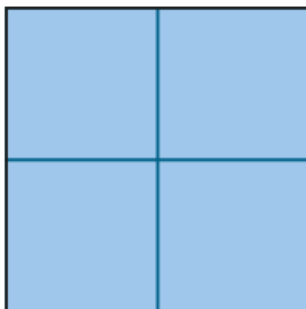

5. Here is a sketch of a triangle. It is not drawn to scale. Draw the full-size triangle accurately. Use an angle measurer (protractor) and a ruler.

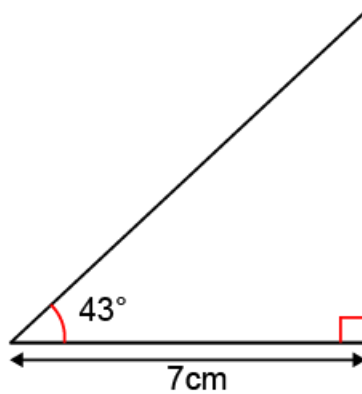

Not drawn to scale

6. Here is a picture of a pentagon made from a regular hexagon and an equilateral triangle. The perimeter of the triangle is 24 cm. What is the perimeter of the pentagon?

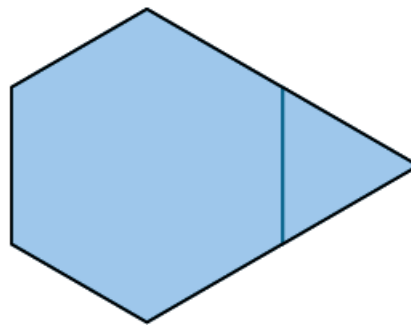

Drawn to scale, not actual size

Calculation and fluency

Number, place value and number facts: 6NPV–1 and 6NPV–2

- **6NPV–1** Understand the relationship between powers of 10 from 1 hundredth to 10 million, and use this to make a given number 10, 100, 1,000, 1 tenth, 1 hundredth or 1 thousandth times the size (multiply and divide by 10, 100 and 1,000).
- **6NPV–2** Recognise the place value of each digit in numbers up to 10 million, including decimal fractions, and compose and decompose numbers up to 10 million using standard and non-standard partitioning.

Pupils should develop fluency in multiplying numbers by 10, 100 and 1,000 to give products with up to 7 digits, and dividing up to 7-digit numbers by 10, 100 and 1,000.

Pupils should be able to carry out calculations based on their understanding of place-value as well as non-standard partitioning, for example:

$$4,000 + 30,000 + 0.2 + 5,000,000 = \boxed{}$$

$$381,920 - 900 = \boxed{}$$

$$518.32 + 30 = \boxed{}$$

$$381,920 - 60,000 = \boxed{}$$

Pupils should also be able to apply their place-value knowledge for larger numbers to known additive and multiplicative number facts, including scaling both factors of a multiplication calculation, for example:

$$8 + 6 = 14$$

$$800,000 + 600,000 = 1,400,000$$

$$3 \times 4 = 12$$

$$3 \times 40,000 = 120,000$$

$$300 \times 400 = 120,000$$

Representations such as place-value counters, partitioning diagrams and Gattegno charts can be used initially to help pupils understand calculation strategies and make connections between known facts and related calculations. However, pupils should not rely on such representations for calculating.

Pupils should maintain fluency in both formal written and mental methods for calculation. Mental methods can include jottings to keep track of calculations. Pupils should select the most efficient method to calculate depending on the numbers involved.

Pupils should learn to check their calculations with a calculator so that they know how to use one. This will help pupils when they progress to key stage 3.

Addition and subtraction: formal written methods

Pupils should continue to practise adding whole numbers with up to 4 digits, and numbers with up to 2 decimal places, using columnar addition. This should include calculations with more than 2 addends, and calculations with addends that have different numbers of digits.

$$\begin{array}{r}
 6, 5 \ 8 \ 4 \\
 + 2, 7 \ 3 \ 9 \\
 \hline
 9, 3 \ 2 \ 3 \\
 \hline
 1 \ 1 \ 1
 \end{array}
 \qquad
 \begin{array}{r}
 1, 6 \ 4 \ 9 \\
 3, 1 \ 0 \ 4 \\
 + \quad 5 \ 1 \ 6 \\
 \hline
 5, 2 \ 6 \ 9 \\
 \hline
 1 \quad 1
 \end{array}
 \qquad
 \begin{array}{r}
 4 \ 7 \cdot 5 \ 2 \\
 + \quad 8 \ 1 \cdot 7 \\
 \hline
 1 \ 2 \ 9 \cdot 2 \ 2 \\
 \hline
 1
 \end{array}$$

Figure 237: range of columnar addition calculations

For calculations with more than 2 addends, pupils should add the digits within a column in the most efficient order. For the second example above, efficient choices could include:

- beginning by making 10 in the ones column
- making double-6 in the hundreds column

Pupils should continue to practise using columnar subtraction for numbers with up to 4 digits, and numbers with up to 2 decimal places. This should include calculations where the minuend and subtrahend have a different numbers of digits or decimal places, and those involving exchange through 0.

$$\begin{array}{r}
 2, 7 \ 9 \ 6 \\
 - \quad 4 \ 8 \ 5 \\
 \hline
 2, 3 \ 1 \ 1
 \end{array}
 \qquad
 \begin{array}{r}
 ^3 ^9 ^1 \\
 8, \cancel{4} \ 0 \ 3 \\
 - \quad 2, 1 \ 7 \ 6 \\
 \hline
 6, 2 \ 2 \ 7
 \end{array}
 \qquad
 \begin{array}{r}
 21.8 - 9.29 \\
 ^1 ^1 ^7 ^1 \\
 \cancel{2}^1 \ 1 \cdot \cancel{8}^7 \ 0 \\
 - \quad 9 \cdot 2 \ 9 \\
 \hline
 1 \ 2 \cdot 5 \ 1
 \end{array}$$

Figure 238: range of columnar subtraction calculations

Pupils should make sensible decisions about how and when to use columnar methods. For example, when subtracting a decimal fraction from a whole number, pupils may be able to use their knowledge of complements, avoiding the need to exchange through zeroes. For example, to calculate $8 - 4.85$ pupils should be able to work out that the decimal complement to 5 from 4.85 is 0.15, and that the total difference is therefore 3.15.

Pupils should learn to check their columnar addition and subtraction calculations with a calculator so that they know how to use one. This will help pupils when they progress to key stage 3.

Multiplication: extending 5MD–3

In year 5, pupils learnt to multiply any whole number with up to 4 digits by any 1-digit number using short multiplication ([5MD–3](#)). They should continue to practise this in year 6. Pupils should also learn to use short multiplication to multiply decimal numbers by 1-digit numbers, and use this to solve contextual measures problems, including those involving money.

$$\begin{array}{r}
 24 \\
 \times 6 \\
 \hline
 144 \\
 \hline
 2
 \end{array}
 \qquad
 \begin{array}{r}
 342 \\
 \times 7 \\
 \hline
 2,394 \\
 \hline
 21
 \end{array}
 \qquad
 \begin{array}{r}
 5.35 \\
 \times 4 \\
 \hline
 21.40 \\
 \hline
 12
 \end{array}$$

Figure 239: range of short multiplication calculations

Pupils should be able to multiply a whole number with up to 4 digits by a 2-digit whole number by applying the distributive property of multiplication ([4MD–3](#)). This results in multiplication by a multiple of 10 (which they can carry out by writing the multiple of 10 as a product of 2 factors ([5MD–3](#)) and multiplication by a one-digit number.

$$\begin{aligned}
 124 \times 26 &= 124 \times 20 + 124 \times 6 \\
 &= 124 \times 2 \times 10 + 124 \times 6 \\
 &= 2,480 + 744 \\
 &= 3,224
 \end{aligned}$$

Pupils should be able to represent this using the formal written method of long multiplication, and explain the connection to the partial products resulting from application of the distributive law.

$$\begin{array}{r}
 12 \\
 124 \\
 \times 26 \\
 \hline
 744 \\
 2,480 \\
 \hline
 3,224 \\
 \hline
 11
 \end{array}$$

Figure 240: long multiplication calculation

Pupils should be fluent in interpreting contextual problems to decide when multiplication is the appropriate operation to use, including as part of multi-step problems. Pupils should use short or long multiplication as appropriate to solve these calculations.

Pupils should learn to check their short and long multiplication calculations with a calculator so that they know how to use one. This will help pupils when they progress to key stage 3.

Division: extending 5MD–4

In year 5, pupils learnt to divide any whole number with up to 4 digits by a 1-digit number using short division, including with remainders ([5MD–4](#)). They should continue to practise this in year 6. Pupils should also learn to use short division to express remainders as a decimal fraction.

$$\begin{array}{r}
 86r2 \\
 5 \overline{)4332}
 \end{array}$$

$$\begin{array}{r}
 619 \\
 8 \overline{)491572}
 \end{array}$$

$$\begin{array}{r}
 27.25 \\
 4 \overline{)1029.1020}
 \end{array}$$

Figure 241: range of short division calculations

For contextual problems, pupils must be able to interpret remainders appropriately as they learnt to do in year 4 ([4NF–2](#)). This should be extended to making an appropriate decision about how to represent the remainder. Consider the question “4 friends equally share the cost of a £109 meal. How much does each of them pay?” Pupils should recognise that an answer of £27 remainder 1 is not helpful in this context, and that they need to express the answer as a decimal fraction (£27.25) to provide a sufficient answer to the question.

Pupils should also be able to divide any whole number with up to 4 digits by a 2-digit number, recording using either short or long division. Pupils are likely to need to write out multiples of the divisor to carry out these calculations and can do this efficiently using a

ratio table – they can write out all multiples up to $10\times$ (working in the most efficient order) or write out multiples as needed.

	$\times 17$
1	17
2	34
3	51
4	68
5	85
6	
7	
8	136

$$\begin{array}{r}
 483 \\
 17 \overline{) 8211} \\
 \underline{68} \\
 141 \\
 \underline{136} \\
 51
 \end{array}$$

Figure 242: long division calculation
($8,211 \div 17$)

Pupils should be fluent in interpreting contextual problems to decide when division is the appropriate operation to use, including as part of multi-step problems. Pupils should use short or long division as appropriate to solve these calculations.

Pupils should learn to check their short and long division calculations with a calculator so that they know how to use one. This will help pupils when they progress to key stage 3.

Appendix: number facts fluency overview

Addition and subtraction facts

The full set of addition calculations that pupils need to be able to solve with automaticity are shown in the table below. Pupils must also be able to solve the corresponding subtraction calculations with automaticity.

+	0	1	2	3	4	5	6	7	8	9	10
0	0+0	0+1	0+2	0+3	0+4	0+5	0+6	0+7	0+8	0+9	0+10
1	1+0	1+1	1+2	1+3	1+4	1+5	1+6	1+7	1+8	1+9	1+10
2	2+0	2+1	2+2	2+3	2+4	2+5	2+6	2+7	2+8	2+9	2+10
3	3+0	3+1	3+2	3+3	3+4	3+5	3+6	3+7	3+8	3+9	3+10
4	4+0	4+1	4+2	4+3	4+4	4+5	4+6	4+7	4+8	4+9	4+10
5	5+0	5+1	5+2	5+3	5+4	5+5	5+6	5+7	5+8	5+9	5+10
6	6+0	6+1	6+2	6+3	6+4	6+5	6+6	6+7	6+8	6+9	6+10
7	7+0	7+1	7+2	7+3	7+4	7+5	7+6	7+7	7+8	7+9	7+10
8	8+0	8+1	8+2	8+3	8+4	8+5	8+6	8+7	8+8	8+9	8+10
9	9+0	9+1	9+2	9+3	9+4	9+5	9+6	9+7	9+8	9+9	9+10
10	10+0	10+1	10+2	10+3	10+4	10+5	10+6	10+7	10+8	10+9	10+10

Pupils must be fluent in these facts by the end of year 2, and should continue with regular practice through year 3 to secure and maintain fluency. It is essential that pupils have automatic recall of these facts before they learn the formal written methods of columnar addition and subtraction.

The [Factual fluency progression](#) table at the end of this appendix summarises the order in which pupil should learn these additive number facts.

Multiplication and division facts

The full set of multiplication calculations that pupils need to be able to solve by automatic recall are shown in the table below. Pupils must also have automatic recall of the corresponding division facts.

1×1	1×2	1×3	1×4	1×5	1×6	1×7	1×8	1×9	1×10	1×11	1×12
2×1	2×2	2×3	2×4	2×5	2×6	2×7	2×8	2×9	2×10	2×11	2×12
3×1	3×2	3×3	3×4	3×5	3×6	3×7	3×8	3×9	3×10	3×11	3×12
4×1	4×2	4×3	4×4	4×5	4×6	4×7	4×8	4×9	4×10	4×11	4×12
5×1	5×2	5×3	5×4	5×5	5×6	5×7	5×8	5×9	5×10	5×11	5×12
6×1	6×2	6×3	6×4	6×5	6×6	6×7	6×8	6×9	6×10	6×11	6×12
7×1	7×2	7×3	7×4	7×5	7×6	7×7	7×8	7×9	7×10	7×11	7×12
8×1	8×2	8×3	8×4	8×5	8×6	8×7	8×8	8×9	8×10	8×11	8×12
9×1	9×2	9×3	9×4	9×5	9×6	9×7	9×8	9×9	9×10	9×11	9×12
10×1	10×2	10×3	10×4	10×5	10×6	10×7	10×8	10×9	10×10	10×11	10×12
11×1	11×2	11×3	11×4	11×5	11×6	11×7	11×8	11×9	11×10	11×11	11×12
12×1	12×2	12×3	12×4	12×5	12×6	12×7	12×8	12×9	12×10	12×11	12×12

Pupils must be fluent in these facts by the end of year 4, and this is assessed in the multiplication tables check. Pupils should continue with regular practice through year 5 to secure and maintain fluency.

The 36 most important facts are highlighted in the table. Fluency in these facts should be prioritised because, when coupled with an understanding of commutativity and fluency in the formal written method for multiplication, they enable pupils to multiply any pair of numbers.

The [Factual fluency progression](#) table at the end of this appendix summarises the order in which pupil should learn these multiplicative number facts. Pupils should learn the multiplication tables in the 'families' described in the progression table – making connections between the multiplication tables in each family will enable pupils to develop automatic recall more easily, and provide a deeper understanding of multiplication and division.

Factual fluency progression

	Year 1	Year 2	Year 3	Year 4	Year 5
Additive factual fluency	Addition and subtraction within 10.	Addition and subtraction across 10.	Secure and maintain fluency in addition and subtraction within and across 10, through continued practice.		
Multiplicative factual fluency			Recall the 10 and 5 multiplication tables, and corresponding division facts.	Recall the 3, 6 and 9 multiplication tables, and corresponding division facts.	Secure and maintain fluency in all multiplication tables, and corresponding division facts, through continued practice.
			Recall the 2, 4 and 8 multiplication tables, and corresponding division facts.	Recall the 7 multiplication table, and corresponding division facts.	
				Recall the 11 and 12 multiplication tables, and corresponding division facts.	



Department
for Education



National Centre
for Excellence in the
Teaching of Mathematics

© Crown copyright 2020

This publication (not including logos) is licensed under the terms of the Open Government Licence v3.0 except where otherwise stated. Where we have identified any third party copyright information you will need to obtain permission from the copyright holders concerned.

To view this licence:

visit www.nationalarchives.gov.uk/doc/open-government-licence/version/3

email psi@nationalarchives.gsi.gov.uk

write to Information Policy Team, The National Archives, Kew, London, TW9 4DU

About this publication:

enquiries www.education.gov.uk/contactus

download www.gov.uk/government/publications

Reference: DfE-00100-2020



Follow us on Twitter:
[@educationgovuk](https://twitter.com/educationgovuk)



Like us on Facebook:
facebook.com/educationgovuk